

## Omega™ 4K/UHD HDMI Over HDBaseT Receiver with USB, Control, and PoE AT-OME-EX-RX

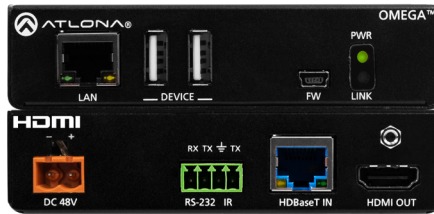

The Atlona **AT-OME-EX-RX** is an HDBaseT receiver for video up to 4K/60 4:2:0, plus embedded audio, control, Ethernet, and USB over distances up to 330 feet (100 meters). Part of the Omega™ Series of integration products for modern AV communications and collaboration, the OME-EX-RX is HDCP 2.2 compliant and receives IR, RS-232, and IP control signals. With a matching HDBaseT transmitter, the integrated USB extension is ideal for software video conferencing and the use of touch or interactive displays. The OME-EX-RX includes two USB interfaces for devices such as a camera or display. This receiver is ideal for use with Omega Series transmitters as well as switchers with HDBaseT outputs. Also available is the OME-EX-KIT which includes the OME-EX-TX and OME-EX-RX.\*

### Package Contents

- 1 x AT-OME-EX-RX
- 1 x Captive screw connectors, 4-pin
- 2 x Mounting plates
- 4 x Mounting screws
- 1 x 48 V DC power supply
- 1 x Installation Guide



**IMPORTANT:** Visit <http://www.atlona.com/product/AT-OME-EX-RX> for the latest firmware updates and User Manual.

\* The AT-OME-EX-RX is not compatible with the AT-UHD-HDVS-300 system for extending USB.

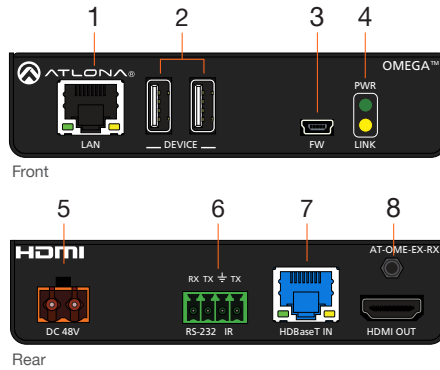

- 1 LAN**  
Connect a category cable from this port to the display (sink) device. This cable provides IP pass-through transport control to the display (sink) device, from a control system connected to the transmitter.
- 2 DEVICE**  
Connect up to two USB 2.0 devices (e.g. mouse, keyboard, etc.) to these ports. These ports provide 2.5 W per USB device.
- 3 FW**  
Connect a mini USB-to-USB cable from this port, to a computer, to update the firmware. Refer to [Updating the Firmware \(page 10\)](#) for more information.
- 4 PWR / LINK**  
The **PWR** LED indicator will glow green when the AT-OME-EX-RX is powered. The **LINK** LED indicator glows yellow when a solid link is established between the transmitter and the AT-OME-EX-RX. Refer to [LED Indicators \(page 5\)](#) for more information.
- 5 DC 48V**  
Connect the included 48 V DC power supply to this power receptacle.
- 6 RS-232 / IR**  
Connect the included 4-pin captive screw block to this receptacle. Refer to [RS-232 and IR \(page 3\)](#) for more information.
- 7 HDBaseT IN**  
Connect a category cable from this port to the **HDBaseT OUT** port of the AT-OME-EX-TX or other PoE-compatible transmitter.
- 8 HDMI OUT**  
Connect an HDMI cable from this port to the display (sink) device.



## RS-232 and IR

The AT-OME-EX-RX provides pass-through transport of RS-232 protocol and/or IR over HDBaseT, which allows communication between a control system and an RS-232 or IR device. This step is optional.

1. Use wire strippers to remove a portion of the cable jacket.
2. Remove at least 3/16" (5 mm) from the insulation of the RX, TX, and GND wires for the RS-232 connection.
3. Insert the TX, RX, and GND wires into correct terminal using one of the included 4-pin captive screw connectors.
4. Repeat step 2 for the S and GND wires for the IR connection.
5. Insert the S (signal) wire in to the TX terminal and the ground wire to the GND terminal.
6. Tighten the captive screws to secure the wires in place. Do not over-tighten or use high-torque devices to prevent damage to the connector block.



**NOTE:** Typical DB9 connectors use pin 2 for TX, pin 3 for RX, and pin 5 for ground. On some devices functions of pins 2 and 3 are reversed. Note that the signal (S) pin for the IR is labeled as "TX" on the port.

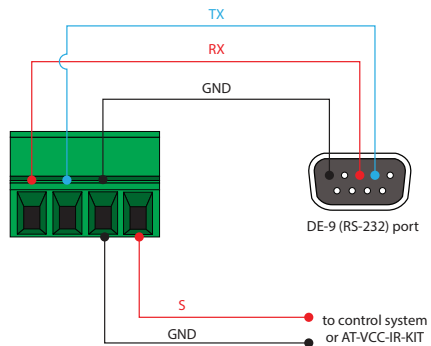
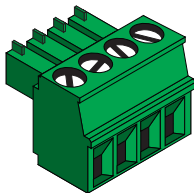

## Installation

1. Connect a UHD/HD display to the **HDMI OUT** port.
2. Connect up to two USB devices (mouse, keyboard, etc.) to the **DEVICE** ports. These ports provide 2.5 W per USB device.
3. Connect a category cable, from the **HDBaseT IN** port on the AT-OME-EX-RX, to the **HDBaseT OUT** port on the transmitter.
4. OPTIONAL: Connect an Ethernet cable from the **LAN** port on the AT-OME-EX-RX, to the display (sink) device. This cable provide IP pass-through transport control from a control system to the display (sink) device connected to the AT-OME-EX-RX.
5. OPTIONAL: Connect the RS-232 device to the **RS-232** port on the AT-OME-EX-RX. Refer to [RS-232 and IR \(page 3\)](#) for more information.
6. OPTIONAL: Connect an IR emitter to the **IR** port on the transmitter. Connect an IR receiver to the **IR** port on the AT-OME-EX-RX. Refer to [RS-232 and IR \(page 3\)](#) for more information.
7. Connect the included 48 V DC power supply to the **DC 48V** power receptacle on the transmitter.
8. Connect the power supply to an available AC outlet.

## Cable Recommendation Guidelines

Refer to the tables below for recommended cabling when using Altona products with HDBaseT. The green bars indicate the signal quality when using each type of cable. Higher-quality signals are represented by more bars.

Core	Shielding	CAT5e	CAT6	CAT6a	CAT7
Solid	UTP (unshielded)	■	■■■	■■■■	N/A
	STP (shielded)	■■	■■■■	■■■■■	■■■■■



**IMPORTANT:** Stranded or patch cables are not recommended due to performance issues.



Cable*	Max. Distance @ 4K	Max. Distance @ 1080p
CAT5e	295 feet (90 meters)	330 feet (100 meters)
CAT6 / CAT6a / CAT7	330 feet (100 meters)	330 feet (100 meters)



\*Atlona recommends TIA/EIA 568-B termination for optimal performance.



## LED Indicators

The **PWR** and **LINK** LED indicator provide basic information on the current status of the AT-OME-EX-RX.

PWR		Description
Solid green		AT-OME-EX-RX is powered.
Off		AT-OME-EX-RX is not powered. <ul style="list-style-type: none"> <li>• Verify that the locking connector is securely fastened to the power receptacle.</li> <li>• Make sure that the power supply is connected to an active AC outlet.</li> </ul>

LINK		Description
Solid yellow		The link integrity between the transmitter and the AT-OME-EX-RX is good.
Blinking yellow		Poor signal integrity between the transmitter and the AT-OME-EX-RX. <ul style="list-style-type: none"> <li>• Make sure that the category cable between the <b>HDBaseT IN</b> port on the transmitter and the <b>HDBaseT OUT</b> port on the AT-OME-EX-RX is secure.</li> <li>• The category cable may be compromised. Try using a different category cable. Make sure that the cable is solid core. Stranded or patch cables are not recommended.</li> </ul>
Off		The link integrity between the transmitter and the AT-OME-EX-RX is compromised. <ul style="list-style-type: none"> <li>• Check the category cable between the <b>HDBaseT IN</b> port on the transmitter and the <b>HDBaseT OUT</b> port on the AT-OME-EX-RX.</li> </ul>

## Mounting Instructions

The AT-OME-EX-RX provides two mounting brackets, which can be used to attach the AT-OME-EX-RX to any flat surface. Use the two enclosure screws, on the sides of the AT-OME-EX-RX to attach the mounting brackets.

1. Using a small Phillips screwdriver, remove the two screws from the left side of the enclosure.



2. Position one of the mounting brackets, as shown below, aligning the holes on the side of the enclosure with one set of holes on the mounting bracket.
3. Use the screws from Step 1 to attach the mounting bracket.





4. Repeat these steps to attach the second mounting bracket to the opposite side of the AT-OME-EX-RX.
5. Mount the AT-OME-EX-RX to a flat surface using the oval-shaped holes, on each mounting bracket. If using a drywall surface, a #6 drywall screw is recommended.



## Analyzer Software

The Analyzer software provides HDBaseT testing, debugging, and firmware update utilities. The software can be downloaded from the Resource tab located at <https://atlon.com/product/at-ome-ex-kit/>.

### HDBaseT Testing

1. Launch the Analyzer software.
2. Make sure the system is powered and the transmitter and receiver are connected using the **HDBaseT OUT** and **HDBaseT IN** ports.
3. Connect an active source to the transmitter and an active display to the receiver. Set the source to the highest resolution.
4. Connect a mini-USB to USB-A cable from the **FW** port, on the transmitter, to a computer.
5. Click the **Port** drop-down list and select the COM port, then click the **Connect** button.

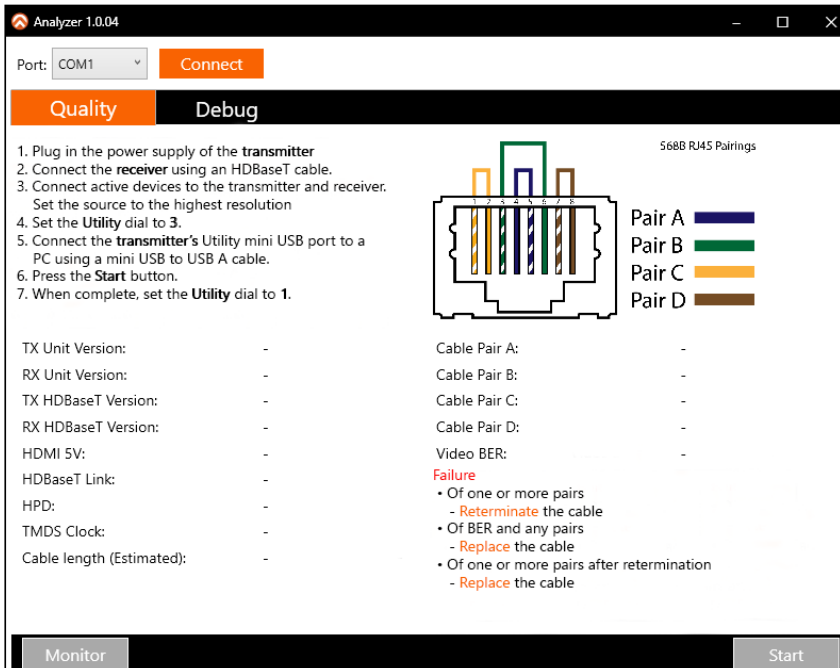

6. Click **Quality** in the menu bar.
7. Click the **Start** button in the lower-right right corner of the window. The link information and cable pairing test results will display. Follow the instructions on the Analyzer software for any pair failures.



## Debug

1. Launch the Analyzer software.
2. Make sure the system is powered and the transmitter and receiver are connected using the **HDBaseT OUT** and **HDBaseT IN** ports.
3. Connect an active source to the transmitter and an active display to the receiver. Set the source to the highest resolution.
4. Connect a mini-USB to USB-A cable from the **FW** port, on the transmitter, to a computer.
5. Click the **Port** drop-down list and select the COM port, then click the **Connect** button
6. Click **Debug** in the menu bar.

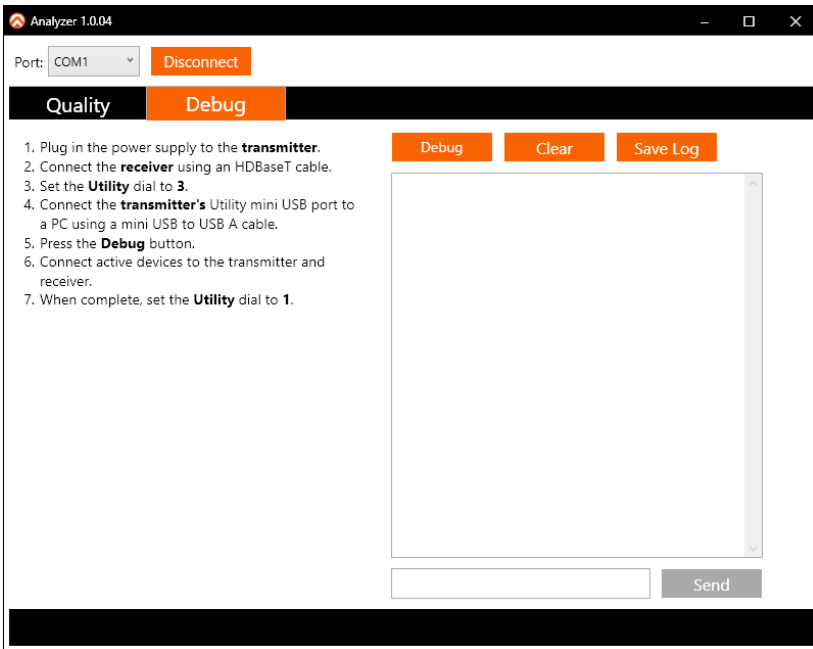

7. Click the **Debug** button. Information will appear in the box field if there is any data that can be logged. The log can be saved to the local computer if needed.

## Updating the Firmware

Requirements:

- AT-OME-EX-RX
- Firmware file
- Computer running Windows
- USB-A to USB mini-B cable



**NOTE:** The update process can take up to five minutes to complete.

1. Disconnect power from the AT-OME-EX-RX.
2. Connect a USB-A to USB mini-B cable between the PC and the **FW** port on the AT-OME-EX-RX.
3. Connect the included power supply to the AT-OME-EX-RX.
4. The USB UPDATE folder will be displayed. If this folder is not displayed, automatically,

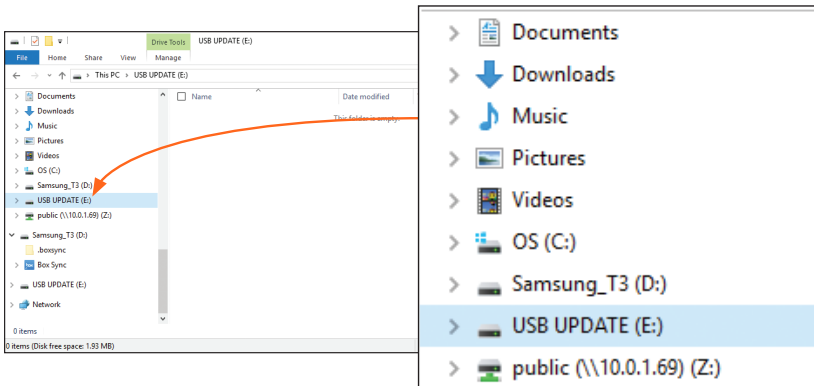

select the USB UPDATE drive from Windows Explorer.

5. Delete all files from the USB UPDATE drive, if any are present.
6. Drag-and-drop the firmware file to the drive.
7. The **PWR** LED indicator, on the front panel, will flash green while the AT-OME-EX-RX is being updated. Do not disconnect the USB cable during the update process. When the **PWR** LED stops flashing and is solid green, the update process will be complete.
8. Disconnect the USB cable from the AT-OME-EX-RX.

## Atlona, Inc. (“Atlona”) Limited Product Warranty

### Coverage

Atlona warrants its products will substantially perform to their published specifications and will be free from defects in materials and workmanship under normal use, conditions and service.

Under its Limited Product Warranty, Atlona, at its sole discretion, will either:

- repair or facilitate the repair of defective products within a reasonable period of time, restore products to their proper operating condition and return defective products free of any charge for necessary parts, labor and shipping.

OR

- replace and return, free of charge, any defective products with direct replacement or with similar products deemed by Atlona to perform substantially the same function as the original products.

OR

- refund the pro-rated value based on the remaining term of the warranty period, not to exceed MSRP, in cases where products are beyond repair and/or no direct or substantially similar replacement products exist.

Repair, replacement or refund of Atlona products is the purchaser’s exclusive remedy and Atlona liability does not extend to any other damages, incidental, consequential or otherwise.

This Limited Product Warranty extends to the original end-user purchaser of Atlona products and is non-transferrable to any subsequent purchaser(s) or owner(s) of these products.

### Coverage Periods

Atlona Limited Product Warranty Period begins on the date of purchase by the end-purchaser. The date contained on the end-purchaser’s sales or delivery receipt is the proof purchase date.

### Limited Product Warranty Terms – New Products

- 10 years from proof of purchase date for hardware/electronics products purchased on or after June 1, 2013.
- 3 years from proof of purchase date for hardware/electronics products purchased before June 1, 2013.
- Lifetime Limited Product Warranty for all cable products.

### Limited Product Warranty Terms – Refurbished (B-Stock) Products and Discontinued Products

- 3 years from proof of purchase date for all Refurbished (B-Stock) and Discontinued hardware and electronic products purchased on or after June 1, 2013.

## Remedy

Atlona recommends that end-purchasers contact their authorized Atlona dealer or reseller from whom they purchased their products. Atlona can also be contacted directly. Visit [www.atlona.com](http://www.atlona.com) for Atlona's contact information and hours of operation. Atlona requires that a dated sales or delivery receipt from an authorized dealer, reseller or end-purchaser is provided before Atlona extends its warranty services. Additionally, a return merchandise authorization (RMA) and/or case number, is required to be obtained from Atlona in advance of returns.

Atlona requires that products returned are properly packed, preferably in the original carton, for shipping. Cartons not bearing a return authorization or case number will be refused. Atlona, at its sole discretion, reserves the right to reject any products received without advanced authorization. Authorizations can be requested by calling 1-877-536-3976 (US toll free) or 1-408-962-0515 (US/international) or via Atlona's website at [www.atlona.com](http://www.atlona.com).

## Exclusions

This Limited Product Warranty excludes:

- Damage, deterioration or malfunction caused by any alteration, modification, improper use, neglect, improper packaging or shipping (such claims must be presented to the carrier), lightning, power surges, or other acts of nature.
- Damage, deterioration or malfunction resulting from the installation or removal of this product from any installation, any unauthorized tampering with this product, any repairs attempted by anyone unauthorized by Atlona to make such repairs, or any other cause which does not relate directly to a defect in materials and/or workmanship of this product.
- Equipment enclosures, cables, power supplies, batteries, LCD displays, and any accessories used in conjunction with the product(s).
- Products purchased from unauthorized distributors, dealers, resellers, auction websites and similar unauthorized channels of distribution.

## Disclaimers

This Limited Product Warranty does not imply that the electronic components contained within Atlona's products will not become obsolete nor does it imply Atlona products or their electronic components will remain compatible with any other current product, technology or any future products or technologies in which Atlona's products may be used in conjunction with. Atlona, at its sole discretion, reserves the right not to extend its warranty offering in instances arising outside its normal course of business including, but not limited to, damage inflicted to its products from acts of god.

## Limitation on Liability

The maximum liability of Atlona under this limited product warranty shall not exceed the original Atlona MSRP for its products. To the maximum extent permitted by law, Atlona is not responsible for the direct, special, incidental or consequential damages resulting from any breach of warranty or condition, or under any other legal theory. Some countries, districts or states do not allow the exclusion or limitation of relief, special, incidental, consequential or indirect damages, or the limitation of liability to specified amounts, so the above limitations or exclusions may not apply to you.



## **Exclusive Remedy**

To the maximum extent permitted by law, this limited product warranty and the remedies set forth above are exclusive and in lieu of all other warranties, remedies and conditions, whether oral or written, express or implied. To the maximum extent permitted by law, Atlona specifically disclaims all implied warranties, including, without limitation, warranties of merchantability and fitness for a particular purpose. If Atlona cannot lawfully disclaim or exclude implied warranties under applicable law, then all implied warranties covering its products including warranties of merchantability and fitness for a particular purpose, shall provide to its products under applicable law. If any product to which this limited warranty applies is a “Consumer Product” under the Magnuson-Moss Warranty Act (15 U.S.C.A. §2301, ET SEQ.) or other applicable law, the foregoing disclaimer of implied warranties shall not apply, and all implied warranties on its products, including warranties of merchantability and fitness for the particular purpose, shall apply as provided under applicable law.

## **Other Conditions**

Atlona’s Limited Product Warranty offering gives legal rights, and other rights may apply and vary from country to country or state to state. This limited warranty is void if (i) the label bearing the serial number of products have been removed or defaced, (ii) products are not purchased from an authorized Atlona dealer or reseller. A comprehensive list of Atlona’s authorized distributors, dealers and resellers can be found at [www.atlona.com](http://www.atlona.com).



**Notes**



**Notes**

### English Declaration of Conformity

The English version can be found under the resources tab at:

<https://atlona.com/product/at-ome-ex-rx/>



### Chinese Declaration of Conformity 中国RoHS合格声明

由SKU列出於:

<https://atlona.com/about-us/china-rohs/>



The terms HDMI, HDMI High-Definition Multimedia Interface, and the HDMI Logo are trademarks or registered trademarks of HDMI licensing Administrator, Inc.