

4K HDR Multichannel Digital to Two-Channel Audio Converter

AT-HDR-M2C



The Atlona **AT-HDR-M2C** is an audio converter for extracting and downmixing multichannel PCM, Dolby®, and DTS® audio from HDMI® sources. It features an HDMI input with pass-through, and delivers stereo downmixed audio over a separate HDMI output, as well as analog unbalanced and TOSLINK digital audio outputs. The HDR-M2C is compatible with high dynamic range (HDR) formats and is HDCP 2.2 compliant. It supports 4K/UHD video @ 60 Hz with 4:4:4 chroma sampling, as well as HDMI data rates up to 18 Gbps. This audio converter includes EDID management features as well as audio volume and bass / treble controls, all available via Ethernet through the Atlona Management System (AMS), the web GUI, or a control system. The HDR-M2C can conveniently serve surround sound and two-channel audio systems from a multichannel audio source.

Package Contents

- 1 x AT-HDR-M2C
- 1 x Phoenix terminal block, 3-pin
- 1 x Phoenix terminal block, 2-pin
- 1 x 5V DC power supply
- 1 x Wall/table mounting brackets
- 1 x Installation Guide



IMPORTANT: Visit <http://www.atlona.com/product/AT-HDR-M2C> for the latest firmware updates and User Manual.



Panel Descriptions

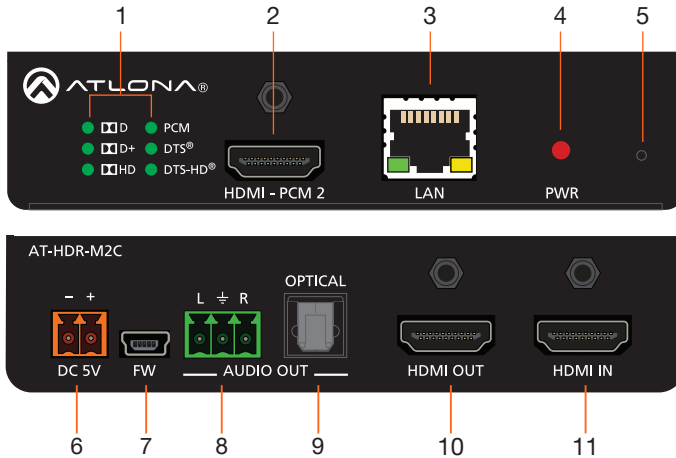

1 Audio Indicators

These LED indicators will glow green to indicate the current audio format of the input signal.

2 HDMI - PCM 2

Connect an HDMI cable from this port to an HDMI display, extender, or switcher. Only two-channel audio is supported.

3 LAN

Connect an Ethernet cable from this port to a Local Area Network (LAN). This port provides access to the web GUI.

4 PWR

This LED indicator will glow red when the unit is powered.

5 IP Mode Button

Press this recessed button with the tip of a pencil or a paperclip, to toggle between static IP and DHCP mode. See page 5 for more information.

6 DC 5V

Connect the included 5V DC power supply to this power receptacle.

7 FW

Connect a mini USB cable to this port to update the firmware.

8 L/R

Connect a 3-pin Phoenix connector from this port to a two-channel audio output device.

9 OPTICAL

Connect an optical audio cable from this TOSLINK port to an audio output device. Only two-channel audio is supported.

10 HDMI OUT

Connect an HDMI cable from this port to a display or other sink device. This output supports multichannel audio.

11 HDMI IN

Connect an HDMI cable from the source to this port.



Audio Connector

The AT-HDR-M2C provides analog audio output of two-channel audio, using a 3-pin Phoenix terminal.

1. Use wire strippers to remove a portion of the cable jacket.
2. Remove at least 3/16" (5 mm) from the insulation of each wire.
3. Insert the wires into the correct terminal on the included Phoenix block, as shown below.
4. Tighten the screws to secure the wires. Do not use high-torque devices as this may damage the screws and/or connector block.

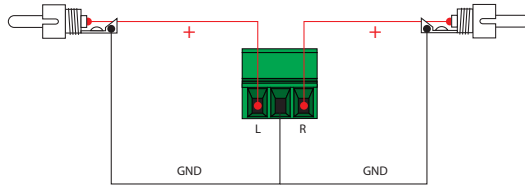
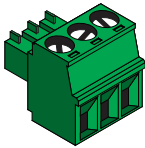

Power Connector

Locate the included orange Phoenix terminal block and wire the included power supply to the block, as shown below. Do not use high-torque devices, when securing the wires, as this may damage the screws and/or connector block.

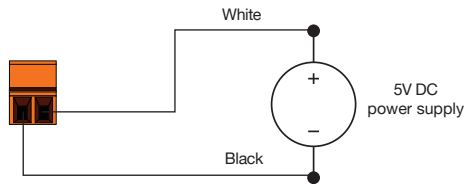
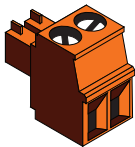

Installation

1. Connect an HDMI cable from the UHD/HD source to the **HDMI IN** port on the AT-HDR-M2C.
2. Connect HDMI cables to the output ports:
 - **Multichannel audio**
Connect an HDMI cable from the **HDMI OUT** port, on the AT-HDR-M2C, to an AV receiver or other multichannel audio device.
 - **Two-channel audio**
Connect an HDMI cable from the **HDMI - PCM 2** port, on the AT-HDR-M2C, to a display or other sink device. Audio output is limited to two-channels.
3. Connect an optical audio cable from the **OPTICAL** port, on the AT-HDR-M2C, to a soundbar or other audio output device. Audio output is limited to two-channels.
4. Connect an Ethernet cable from the **LAN** port on the AT-HDR-M2C, to the Local Area Network (LAN).
5. Connect the green Phoenix block to the **AUDIO OUT** connector.
6. Connect the orange Phoenix block to the **DC 5V** connector.



Mounting Instructions

The AT-HDR-M2C includes two mounting brackets, which can be used to attach the unit to any flat surface. Use the two enclosure screws, on the sides of the unit to attach the mounting brackets.

1. Using a small Phillips screwdriver, remove the two screws from the left side of the enclosure.

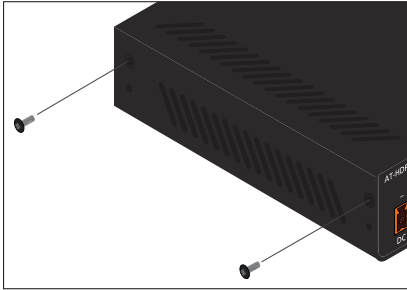

2. Position one of the mounting brackets, as shown below, aligning the holes on the side of the enclosure with one set of holes on the mounting bracket.
3. Repeat steps 1 and 2 to attach the second mounting bracket to the opposite side of the unit.
4. Mount the unit to a flat surface using the oval-shaped holes, on each mounting bracket. If using a drywall surface, a #6 drywall screw is recommended.

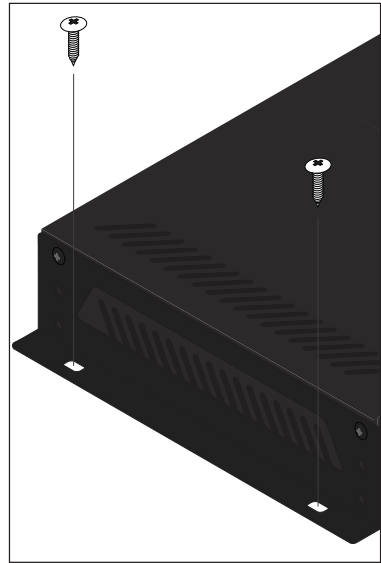
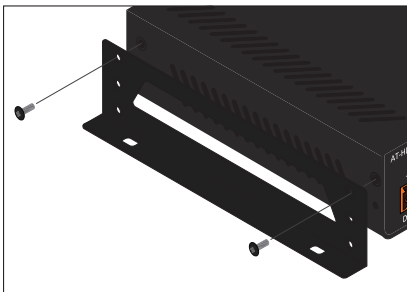

NOTE: Mounting brackets can also be inverted to mount the unit under a table or other flat surface.

WebGUI

The AT-HDR-M2C includes a built-in webGUI, which allows easy management and control of all features. Follow the instructions below to access the webGUI.

1. Set the IP mode of the AT-HDR-M2C. By default, the AT-HDR-M2C is set to DHCP mode.
 - Static IP mode: Press and hold the recessed button for 20 seconds, with the tip of a pencil or paper clip, until the **PWR** indicator blinks twice. The default static IP address is 192.168.1.254.
 - DHCP mode: Press and hold the button until the **PWR** indicator blinks four times.
2. Connect an Ethernet cable from the **LAN** port on the AT-HDR-M2C, to the Local Area Network (LAN).
3. Use an IP scanner to determine the IP address of the AT-HDR-M2C.
4. Launch a web browser and enter the IP address of the unit.
5. The AT-HDR-M2C **Login** page will be displayed.
6. Enter the following information on the **Login** page.
Login: **root**
Password: **Atlona**
7. Click the **Login** button.

Connection Diagram

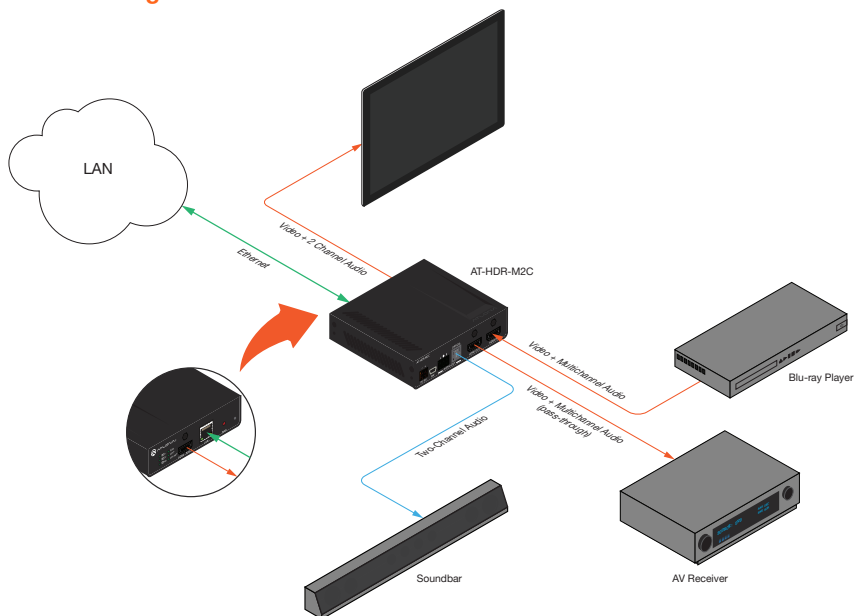

Troubleshooting

Problem	Solution
<p>PWR indicator is off.</p>	<ul style="list-style-type: none"> • Make sure that the orange Phoenix block is connected to the 5V DC terminal. • Verify that the wiring polarity, from the included power supply to the orange Phoenix block, is correct. Refer to the Power Connector section on page 3. • Check that the included power supply is connect to an active AC electrical outlet.
<p>Multichannel audio is not heard when using the OPTICAL connector.</p>	<ul style="list-style-type: none"> • The OPTICAL connector only supports two-channel LPCM audio. To hear a multichannel audio source, connect an HDMI cable from the HDMI OUT port on the AT-HDR-M2C to the sink device.
<p>No multichannel audio on the HDMI output.</p>	<ul style="list-style-type: none"> • Make sure that the HDMI cable is connected from the sink device to the HDMI OUT port on the AT-HDR-M2C.
<p>Two-channel audio is not heard on the output.</p>	<ul style="list-style-type: none"> • Make sure that the HDMI cable is connected from the sink device to the HDMI - PCM 2 port on the AT-HDR-M2C.
<p>No video signal on the output.</p>	<ul style="list-style-type: none"> • Verify that an HDMI cable is connected from the source device to the HDMI IN port on the AT-HDR-M2C.



Notes



ATLONA
a **PANDUIT** company

Installation Guide

AT-HDR-M2C

Version 2



atlona.com • Toll free US 877.536.3976 • International 41.43.508.4321

© 2019 Atlona Inc. All rights reserved. "Atlona" and the Atlona logo are registered trademarks of Atlona Inc. All other brand names and trademarks or registered trademarks are the property of their respective owners. Pricing, specifications and availability subject to change without notice. Actual products, product images, and online product images may vary from images shown here.