

Atlona 6 Input Switcher and Scaler with HDBaseT and Mirrored HDMI Output

AT-UHD-CLSO-612ED

User Manual



Please check <http://www.atlona.com/product/AT-UHD-CLSO-612ED> for the most recent **firmware update** or **manual**.

Table of Contents

1. Introduction	3
2. Package Contents	3
3. Features	3
4. Panel Descriptions	
a. Front Panel	4
b. Rear Panel	4
5. Wall/Rack Mounts	5
6. Category Cable	5
7. Analog Multi-Format Inputs	6
8. Audio Connections	7
9. Microphone	8
10. On Screen Display	9-11
11. TCP/IP and GUI	12-20
12. IR	21-23
13. RS-232	
a. Connection	24
b. Set Up	24
c. Commands	25-27
d. IP Commands	28
e. Baud Rate	28-29
f. Control Diagram	29
14. Connection & Installation	30-31
15. Control Drivers	31
16. CLSO-612 Updating	31
17. Specifications	32-33
18. Safety	33
19. Warranty	34-35
20. Registration	35

Introduction

The Atlona AT-UHD-CLSO-612ED is an advanced six-input, multi-format switcher with 4K scaling, Ethernet-enabled HDBaseT™, and PoE capabilities. It simplifies classroom and small office system integration by providing two HDBaseT inputs, two HDMI inputs, two multi-function analog inputs, plus mirrored HDBaseT and HDMI outputs. Advanced Automatic System Control (AASC) features on the switcher provide automatic display control and automatic input selection. An internal Ethernet hub in on the switcher enables control signal pass-through and network distribution. The AT-UHD-CLSO-612ED contains a full RS-232 signal distribution system to route control signals to local sources and displays. Professional audio features such as a microphone input with 48-volt phantom power and ducking eliminates additional voice-lift audio needs. The switcher is configured and managed by Atlona Management System software to reduce installation time and enable remote support. The AT-UHD-CLSO-612ED addresses a wide array of AV switching and processing needs often encountered in classrooms, conference rooms, boardrooms, training rooms and other presentation settings.

Package Contents

- 1 x AT-UHD-CLSO-612ED
- 11 x Female captive screw connector
 - 6 pin: audio, 5 pin: IR, 3 pin: RS-232, 3 pin: MIC/Line
- 1 x 48V/3.125A DC power supply adaptor
- 1 x Pair of dual purpose wall/rack mounts
- 1 x IR remote control
- 1 x User manual

Features

- Accepts HDMI and HDBaseT inputs from up to 328 feet away
- Multifunctional VGA ports for RGBHV, component, S-Video, and composite signals
- Microphone (dynamic, phantom, and line) input with ducking
- HDBaseT output mirrored to HDMI output
- Automatic display control
- Auto switching - automated switching to last connected source without using a control system
- Balanced audio inputs for embedding audio
- Balanced (+4 dbu) analog audio output for de-embedding audio to amplifiers or audio systems
- Upscaling and downscaling to ensure compatibility with any display or source up to 4K resolution
- Control via RS-232, IR, TCP/IP, WebGUI, and multi-language On-Screen Display
- Master and sub volume control
- Adjust treble and bass on audio output to ensure the best speaker performance
- PoE to HDBaseT inputs and outputs (no power required with compatible devices)
- HDCP Compliant with management for non-compliant HDCP sinks
- Supports 3D pass through

Consumer Electronics Control (CEC): Atlona has confirmed proper CEC functionality with several current models of Samsung, Panasonic, and Sony displays. However, it is not guaranteed that CEC will work with all displays. Many manufacturers do not support the CEC "off" command, and older displays use proprietary commands. Atlona only supports displays that use the CEC command structure defined in HDMI 1.2a. It is recommended that dealers request an evaluation product from Atlona, before designing a system using the CEC protocol. If this is not possible, then other control methods will need to be considered, in order to control displays using Atlona products.

Panel Description

Front Panel

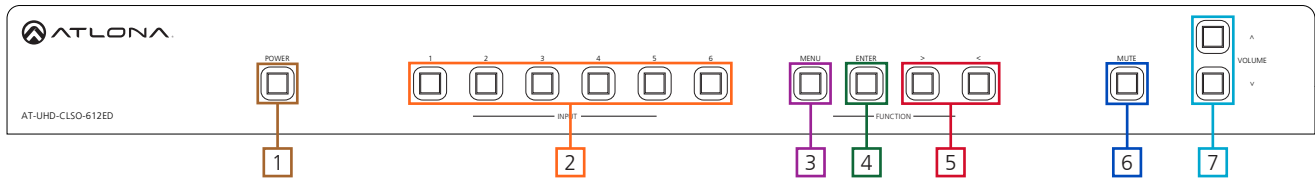

1. **Power:** Use to turn the unit on, place into standby, or turn the display on/off. LED will illuminate blue for on and red for standby
2. **Input:** Switch between inputs - current input is blue
 - 1 - HDMI input 1 - Used while updating MCU firmware
 - 2 - HDMI input 2 - Used while updating OSD firmware
 - 3 - HDBaseT input 1 - Used while updating DSP firmware
 - 4 - HDBaseT input 2 - Used while updating FPGA firmware
 - 5 - Multifunction analog input 1
 - 6 - Multifunction analog input 2
3. **Menu:** Access the OSD menu - also used as a back button within the OSD
4. **Enter:** Select options within the OSD menu
5. **< and >:** Changes values of the currently select option (**e.g.** contrast to 50)
6. **Mute:** Silences all audio output from the CLSO-612ED and (when programmed - see page X) mutes the display
7. **Volume ^/v:** Used to adjust volume (CLSO or Display) and navigate the OSD menu

Back Panel

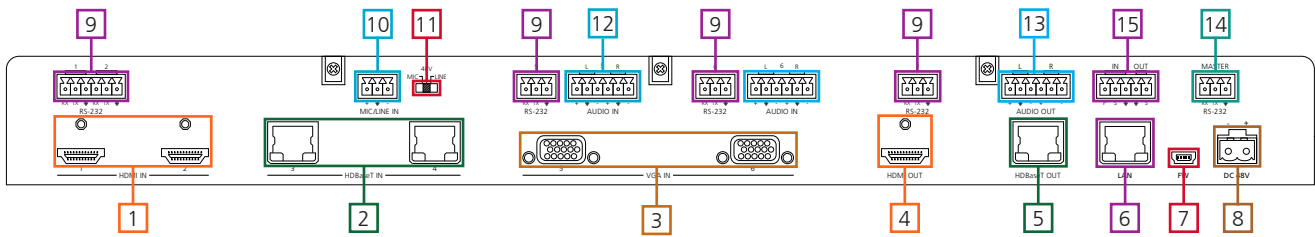

1. **HDMI 1 and 2:** Connect HDMI sources here
2. **HDBaseT 3 and 4 (blue):** Connect HDBaseT transmitters here (e.g. AT-HDVS-200-TX, etc)
Note: Power source equipment (PSE) transmitters require external power (e.g. AT-UHD-EX-100CE-TX, etc)
3. **VGA 5 and 6:** Connect analog video sources here
Note: Compatible with component, composite, and S-Video signals
4. **HDMI Output:** Connect to local display
5. **HDBaseT (blue) Output:** Connect to an HDBaseT PoE receivers (e.g. AT-UHD-EX-100CE-RX, etc)
Note: Compatible PoE receivers do not need power
6. **LAN (black) port:** Connect network switch or router to this port for Ethernet, TCP/IP, or webGUI control
7. **FW port:** Firmware update port, connect a mini USB to USB A cable to a computer
Note: Firmware is downloadable through <http://www.atlona.com/product/AT-UHD-CLSO-612ED/>
8. **DC 48V port:** Connect included power supply here
9. **RS-232 ports:** Connect RS-232 devices to these ports for zone and display control
10. **MIC/LINE IN:** Connect a microphone to this port
11. **MIC Switch:** Match microphone input to type of microphone in use
12. **Audio In:** Audio input ports for analog inputs 5 and 6
13. **Audio Out:** Audio output to audio amplifiers (e.g. AT-PA100-G2) or audio systems
14. **MASTER RS-232 port:** Connect a PC or control system to this port in order to control the AT-UHD-CLSO-612ED
15. **IR IN/OUT port:** Connect an IR receiver/emitter to this port for display control

Note: To ensure compatibility, please be certain both transmitter and receiver have blue HDBaseT ports. Blue ports indicate PoE (48V) compliancy. The CLSO-612ED cannot power PoCC (black RJ45, 24V) receivers/transmitters.

Wall/Rack mounts

A pair of mounts are included for quick and easy installation to a rack or wall.

To install the CLSO-612ED in a rack, use the screws already in the case (A-pictured below)

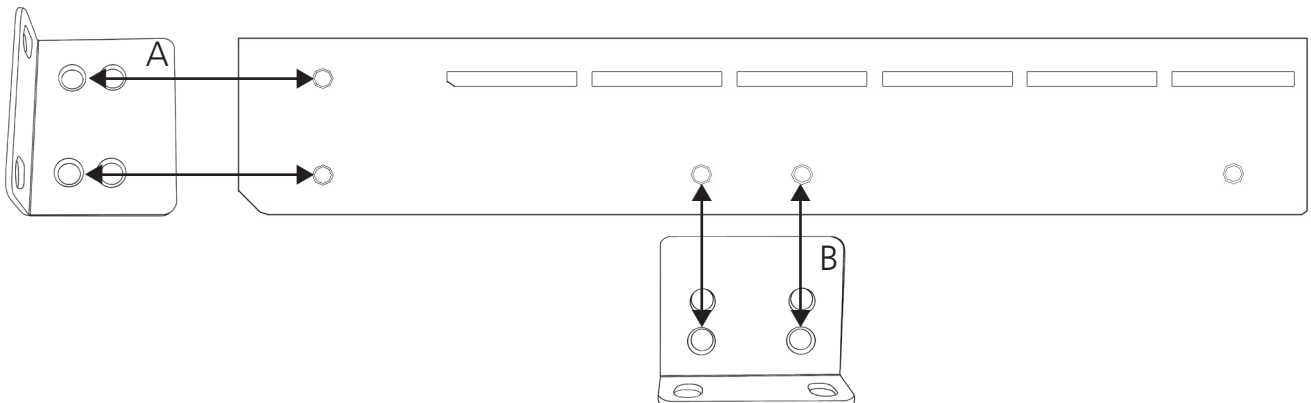

To install the CLSO-612ED on a wall or under a desk/table, use the screws already in the case (B - pictured above)

Category Cable

For the category cables used in the installation of these products, please be sure to use a 568B termination as pictured below:

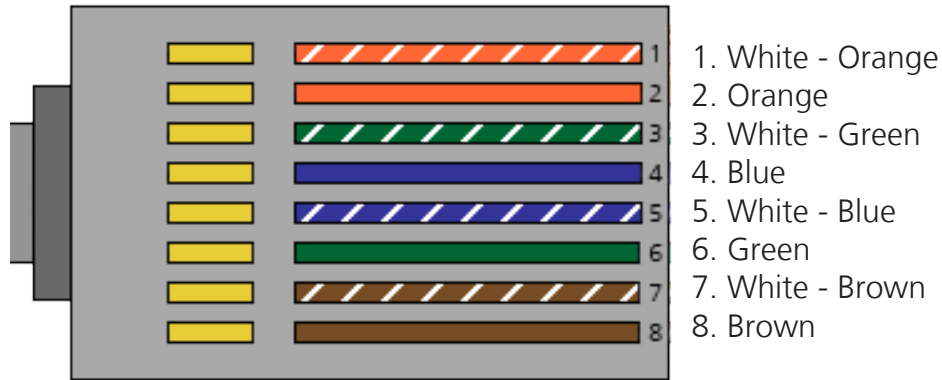

Use the table below to verify the best category cable for the installation.

Performance Rating		Type of LAN cable	
Wiring	Shielding	CAT5e/6	CAT6a/7
Solid	Shielded (STP/FTP)	***	****
	Unshielded (UTP)	**	N/A
Stranded - Patch cable (Not recommended)	Unshielded (UTP)	*	N/A
	Shielded (STP/FTP)	*	N/A
Termination		Please use EIA/TIA-568-B termination	

Important! 4K (UHD) signals are sensitive to cable quality and installation technique. It is recommended to use CAT6a/7 solid core cables for best results.

Note: For cable distances see the specifications on page 20

Connector

Connector type and size is very important to ensure extenders work correctly. Please use the matching cable type with the correct RJ45 connector.

CAT5e cables should use only CAT5e RJ45 connectors

CAT6 cables should use only CAT6 connectors

CAT6a cables should use only CAT6a connectors

CAT7 cables should use only CAT7 connectors

Using the wrong size connectors may result in interference causing loss of signal.

Important! "EZ RJ45 connectors" are not recommended with HDBaseT extenders. Doing so may result in interference with audio and video transmission.

Analog Multi-Function Inputs

The CLSO-612ED multi-function analog inputs (Input 5 and 6) can be used with most analog video signal formats including VGA (with DDC), RGBHV (without DDC), component (YUV), S-Video, or composite video. Balanced analog audio can be input and embedded using the provided captive screw connectors.

Each format can be directly accessed from RS-232, IR, or IP control. Front panel buttons sequentially progress through each input format. The last format used is the first source selected when returning to these inputs. Unused formats can be removed from the sequence using the WebGUI, RS-232, or IP.

VGA (m) to BNC, VGA (m) to RCA, and S-Video to 2 BNC adaptors can be used to connect sources to these inputs.

VGA

Use a VGA to VGA cable to ensure that the Preferred Resolution DDC is communicated to your source.

RGBHV

Use a HD-15 (VGA) to 5 BNC breakout cable for this format. An existing RGBHV analog matrix switch can be connected here to maintain full function of the analog matrix.

Component

YUV (YPbPr) signal from DVD (or other sources) can be input to the CLSO-612ED using the green (Y), blue (P_B), and red (P_R) connections on a HD-15 (VGA) to 5 BNC breakout cable or with a common VGA (m)-Component (3 RCA m) adaptor.

S-Video

YC signal from a VCR or teleconference system can be input to the CLSO-612ED using the blue (Y), and green (C) connections on a HD-15 (VGA) to 5 BNC (m) breakout cable and a common S-Video (m) to 2 BNC (f) adaptor

Composite

NTSC, PAL, or Secam video signals can be input to the CLSO-612ED using the blue connection on a HD-15 (VGA) to 5 BNC (m) breakout cable.

A common application for this type of input would be to connect a RGBHV matrix switcher to the CLSO-612ED. Then each input to the matrix could be connected to a different format analog signal. A 3rd party control system could ensure the correct format is selected to match the input to the switcher.

Captive Screw

The captive screw connectors allow you to cut cables to a suitable length, reducing cable clutter while providing a more reliable connection.

Connecting

When connecting the cables to the female captive screw connector it is important that the wires be terminated correctly. The female captive screw connector has a contact plate at the top and must have the wires touching it for signal to pass. When wired correctly (see picture A) the signal will pass, incorrectly (see picture B) no signal will pass.

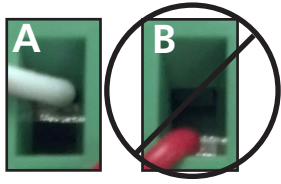

The captive screw connectors have a contact bar that is adjusted to compress the wire against the top contact plate. Use the screws at the top of the connector to compress the wire against the contact plate.



Turn the screws clockwise to raise the contact bar to the upper contact plate and hold the wires in place.



Turn the screws counter clockwise to lower the contact bar to release the wires.

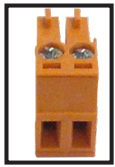

Power



Black: - White: +

The power cable (picture 1) will have exposed wires. Each wire is encased in a different colored cover.

Analog Audio

A captive screw analog audio connector is provided to ensure a more reliable and secure connection. The captive screw connector supports balanced and unbalanced audio output.

Balanced audio connections use two signal wires and a ground to minimize interference to an audio signal over longer cable runs. Unbalanced audio connections use two wires for connection with consumer audio components.

Audio can be routed to any input for use with DVI or other sources. View page 28 for commands.

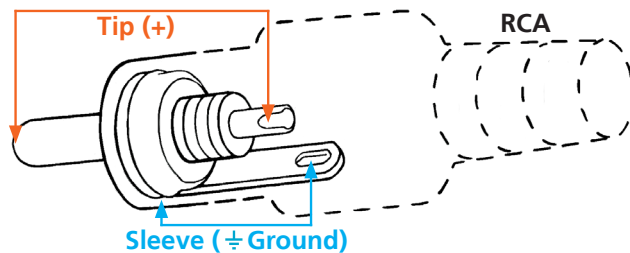
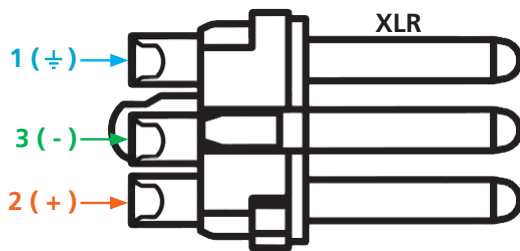

Note: Pin outs may vary, please refer to the audio device's manual to ensure a correct connection.

Important! When terminating cables, please ensure exposed adjacent wires do not touch. This may result in a short that can damage connected devices.

BALANCED

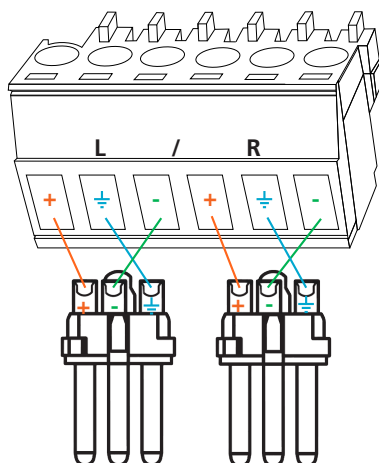

UNBALANCED

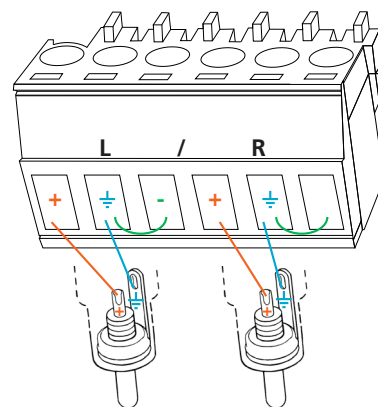

Important! With unbalanced connections a jumper is needed between ground and negative to reduce noise

Microphone Connection

MIC (Dynamic MIC)

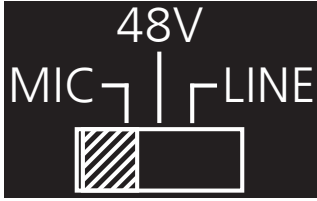

Connect dynamic or self-powered microphones in this mode.

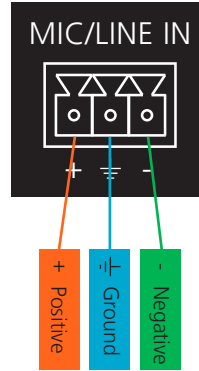

MIC
Balanced

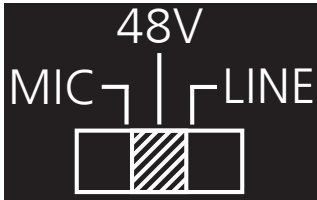

Use this setting for phantom powered microphones. Supplies 48 volts.

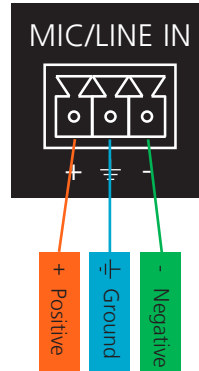

MIC
Balanced

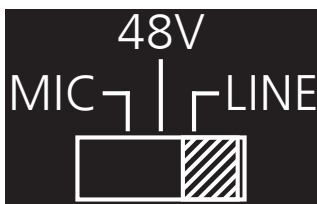

Connect wireless microphone receivers (or other sources) with line level outputs using this setting. Either balanced or unbalanced connections may be used.

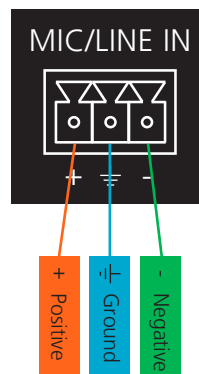

LINE
Balanced

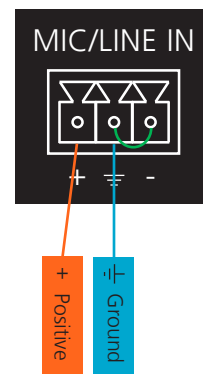

LINE
Unbalanced

On Screen Display (OSD)

Input	Input 1	HDMI 1		
	Input 2	HDMI 2		
	Input 3	HDBaseT 1		
	Input 4	HDBaseT 2		
	Input 5	VGA 1		
		Component 1		
		Composite 1		
		S-Video 1		
	Input 6	VGA 2		
		Component 2		
		Composite 2		
		S-Video 2		
	Audio	Volume	Master	-80 to +10db
			Sub	HDMI 1
HDMI 2				-80 to +10db
HDBaseT 1				-80 to +10db
HDBaseT 2				-80 to +10db
Analog 1				-80 to +10db
Analog 2				-80 to +10db
Microphone				-80 to +10db
Line In		-80 to 0db		
Bass		-10 to 12 dB		
Treble	-10 to 12 dB			
Video	Contrast	0 to 100		
	Brightness	0 to 100		
	Sharpness	0 to 30		
	Color	0 to 100		
	Tint	0 to 100		
	H Position	0 to 40		
	Phase	0 to 63		
	NR	BNR	Disabled	
			Low	
			Medium	
			High	
		MNR	Disabled	
			Low	
			Medium	
			High	
		RNR	Disabled	
			Low	
			Medium	
			High	
	Scale	Full		
Overscan				
Underscan				
Letterbox				
Panscan				
Follow Input				

Setup	Language	English	
		Spanish	
		French	
		German	
	OSD Settings	Transparency	
		Position	Horizontal
			Vertical
		Menu Timer	10 sec
			30 sec
			60 sec
		Logo	On
			Off
	Info Banner	On	
		Off	
	Output Format	HD	Pass Through
			480i@60 (NTSC)
			480p@60
			720p@60
			1080i@60
			1080p@60
			576i@50 (PAL)
		576p@50	
		720p@50	
		1080i@50	
		1080p@50	
		1080p@24	
	Native		
UHD	3840x2160p@24		
	3840x2160p@25		
	3840x2160p@30		
	4096x2160p@24		
	4096x2160p@30		
PC-1	640x480@60		
	640x480@72		
	640x480@75		
	800x600@60		
	800x600@72		
	800x600@75		
	1024x768@60		
1024x768@72			
	1024x768@75		
PC-2	1280x768@60		
	1280x800@60		
	1280x960@60		
	1280x1024@60		
	1360x768@60		
	1366x768@60		
	1400x1050@60		
	1440x900@60		
	1600x900@60		
	1600x1200@60		
	1920x1200@60		
Network	Network Status	MAC Address	
		xx-xx-xx-xx-xx-xx	
		IP Address	
		xxx.xxx.x.xxx	
	Subnet		
	xxx.xxx.xxx.x		
	Gateway		
	xxx.xxx.x.x		
	DHCP		
	ON		
	OFF		

Note: After selecting a new language, close the menu and reopen it for the change to take effect.

Status	System Info	Software Revision	x.x.xx (e.g. 1.0.01)
		OSD Revision	x.x.x (e.g. 1.0.0)
		FPGA Revision	x.x.x (e.g. 1.0.0)
		On-Time (h-m)	x:xx (e.g. 1:15)
	Video Info	Input	xxxx (e.g. HDMI 1)
		Signal Type	xxxx (e.g. HDMI)
		Video Format	xxxx (e.g. 1080i@60)
		Aspect	xxxx (e.g. 16x9)
		Color Space	xxxx (e.g. YUV)
		Color Depth	xxxx (e.g. 24)
	Audio Info	Input	xxxx (e.g. HDMI 1)
		Audio Format	xxxx (e.g. PCM)
Sampling Rate		xxxx (e.g. 48 KHz)	
Channels		xxxx (e.g. 2-Ch)	

TCP/IP

For convenience, the CLSO-612ED comes with DHCP on. This enables the switcher to be connected to a network without concern for overlapping IP addresses with other devices on the network. If your network does not support DHCP, this feature may be turned off and the IP address set using RS-232 commands or the WebGUI.

Note: If your system is controlled using IP, it is strongly recommended that you disable DHCP and select a unused IP address so that your system controller doesn't lose contact with the switcher.

TCP/IP WebGUI

Atlona has created an easy to use WebGUI for initial setup and later changes to the configuration of the CLSO-612ED.

To begin, connect the LAN port of the CLSO-612ED to your network. Type the IP address of the CLSO-612ED into the web browser of a PC connected to the same network (as seen below).

To find the switcher IP: Select "Network Status" within the OSD menu or use RS-232 command "IPCFG".

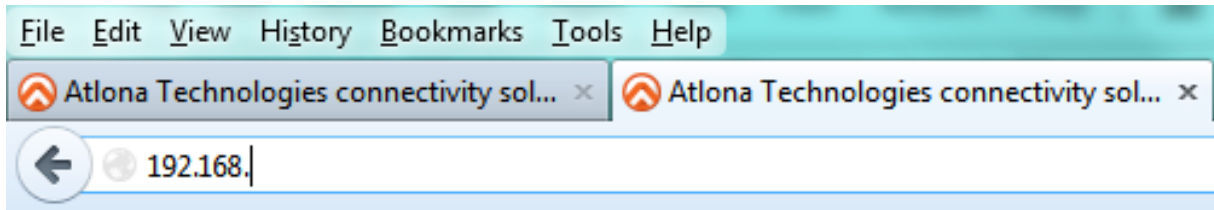

Important: If any stability issues are experienced, disable any anti-virus or firewall that may interfere with network communication to the switcher. Once set up is done and the switcher GUI is no longer being used, the firewall and anti-virus can be re-enabled.



AT-UHD-CLSO-612ED Login



Please input username and password.

Username:

Password:

Login

Clear

A login screen will appear (this is the same log in for admin and general users). For the first log in (and future admin changes) the username is "root" and password is "Atlona".

Note: Only the admin password can be changed (see page 17). The username will always remain "root".

System Info.	
Model:	AT-UHD-CLSO-612ED
Software Revision:	0.2.19
FPGA Revision:	1.0.1
OSD Revision:	1.0.0
On-Time(h-m):	20:39

Video Info.	
Input:	HDMI 1
Signal Type:	HDMI
Video Format:	1080i@60
Aspect:	16x9
Color Space:	RGB
Color Depth:	24

Audio Info.	
Input:	HDMI 1
Audio Format:	PCM
Sampling Rate:	48KHz
Channels:	2-ch

The home screen tab will display the general system information. If an HDMI or HDBaseT port is the current input, audio will display (see image above). If an analog port is selected then no audio information is displayed. (see below)

System Info.	
Model:	AT-UHD-CLSO-612ED
Software Revision:	1.0.01
FPGA Revision:	1.0.1
OSD Revision:	1.0.0
On-Time(h-m):	4:05

Video Info.	
Input:	VGA 1
Signal Type:	--
Video Format:	--
Aspect:	--
Color Space:	--
Color Depth:	--

Home	Network Setup	Settings	Config	EDID	Audio	Control	HDVS	Update
DHCP	<input checked="" type="checkbox"/>	<input type="checkbox"/>						
IP Address	<input type="text" value="192.168.001.106"/>							
Subnet	<input type="text" value="255.255.255.000"/>							
Gateway	<input type="text" value="192.168.001.254"/>							
Telnet Port	<input type="text" value="23"/>							
Login Mode	<input checked="" type="checkbox"/>	<input type="checkbox"/>						
MAC Address	B8-98-B0-00-00-62							

The network set up page will allow the IP information to be changed. When a change is made the screen will grey and the ability to save or cancel will display at the bottom (see below).

Note: When DHCP is on, the IP address cannot be configured. Turn DHCP off to enable IP configuration.

Note: For a stable connection when using a control system, it is best to set up a static IP. When selecting an IP address, make certain no other devices on your network are using that IP address.

Note: Be sure to save all changes before moving to the next page.

Home	Network Setup	Settings	Config	EDID	Audio	Control	HDVS	Update
DHCP	<input type="checkbox"/>	<input checked="" type="checkbox"/>						
IP Address	<input type="text" value="192.168.011.221"/>							
Subnet	<input type="text" value="255.255.255.000"/>							
Gateway	<input type="text" value="192.168.011.001"/>							
Telnet Port	<input type="text" value="23"/>							
Login Mode	<input checked="" type="checkbox"/>	<input type="checkbox"/>						
MAC Address	B8-98-B0-00-00-97							
Save Setting								Cancel

Login Mode has been added to provide a secure telnet login. Once Login Mode has been turned on a username and password will be required on all IP connections to the switcher.

Note: Login mode should be in off position when the CLSO is used with control systems that do not support passwords. If your control system supports password protection, set the login mode to on. The GUI always requires a password.

Note: The username and password used in IP Login Mode will be the same login information as the WebGUI.

System Settings	
Power	ON
Panel Lock	Unlock
Auto Switch	OFF
VGA Auto Switch	OFF

Source	
<input checked="" type="radio"/> HDMI 1	<input type="radio"/> HDMI 2
<input type="radio"/> HDBT 1	<input type="radio"/> HDBT 2
<input type="radio"/> Component 1	<input type="radio"/> Component 2
<input type="radio"/> Composite 1	<input type="radio"/> Composite 2
<input type="radio"/> S-Video 1	<input type="radio"/> S-Video 2
<input type="radio"/> VGA 1	<input type="radio"/> VGA 2

Output Resolution	
<input type="radio"/> Pass through	
<input type="radio"/> Native (HDBaseT)	
<input checked="" type="radio"/> HD	<input type="radio"/> PC
<input type="radio"/> 480i @ 60 (NTSC)	<input type="radio"/> 640x480 @ 60
<input type="radio"/> 480p @ 60	<input type="radio"/> 640x480 @ 72
<input type="radio"/> 720p @ 60	<input type="radio"/> 640x480 @ 75
<input type="radio"/> 1080i @ 60	<input type="radio"/> 800x600 @ 60
<input checked="" type="radio"/> 1080p @ 60	<input type="radio"/> 800x600 @ 72
<input type="radio"/> 576i @ 50 (PAL)	<input type="radio"/> 800x600 @ 75
<input type="radio"/> 576p @ 50	<input type="radio"/> 1024x768 @ 60
<input type="radio"/> 720p @ 50	<input type="radio"/> 1024x768 @ 72
<input type="radio"/> 1080i @ 50	<input type="radio"/> 1024x768 @ 75
<input type="radio"/> 1080p @ 50	<input type="radio"/> 1280x768 @ 60
<input type="radio"/> 1080p @ 24	<input type="radio"/> 1280x800 @ 60
<input type="radio"/> 1080p @ 25	<input type="radio"/> 1280x960 @ 60
<input type="radio"/> 1080p @ 30	<input type="radio"/> 1280x1024 @ 60
<input type="radio"/> 3840x2160 @ 24	<input type="radio"/> 1360x768 @ 60
<input type="radio"/> 3840x2160 @ 25	<input type="radio"/> 1366x768 @ 60
<input type="radio"/> 3840x2160 @ 30	<input type="radio"/> 1400x1050 @ 60
<input type="radio"/> 4096x2160 @ 24	<input type="radio"/> 1440x900 @ 60
<input type="radio"/> 4096x2160 @ 30	<input type="radio"/> 1600x900 @ 60
	<input type="radio"/> 1600x1200 @ 60
	<input type="radio"/> 1920x1200 @ 60

The settings page is used to set front panel and video options. Select the source from the first menu. If VGA is selected, more video options will display. (see top of page 16)

System Settings

Power - Turn the switcher on and off

Panel Lock - Locks/unlocks the front panel buttons

Auto Switch - Turns auto switching between HDMI and HDBaseT inputs on/off

VGA auto switch - Turns VGA auto switching on/off

Note: VGA auto switching is only available on VGA and will not work with component, composite, and S-Video

Component, composite, and S-Video poll settings will grey out when VGA auto switching is on

Output Resolution

Switch between multiple video output resolutions:

Pass through - Input video will pass to the display without being scaled

Native - Upscales/downscales the output signal to match the HDBaseT display's preferred resolution

HD - Will upscale/downscale the output signal to match the selected HD resolution

PC - Will upscale/downscale the output signal to match the selected PC resolution







Note: When the output is set to UHD resolutions, UHD sources are passed through without scaling. Frame rates are not changed. (e.g. if 3840x2160@30Hz input is received, output will remain 30Hz even if output is set to 24Hz)

Video Settings	
Scale	Follow Input ▾
BNR	Medium ▾
MNR	Medium ▾
RNR	Medium ▾

Poll Settings	
<input checked="" type="checkbox"/> VGA 1	<input checked="" type="checkbox"/> VGA 2
<input checked="" type="checkbox"/> Component 1	<input checked="" type="checkbox"/> Component 2
<input checked="" type="checkbox"/> Composite 1	<input checked="" type="checkbox"/> Composite 2
<input checked="" type="checkbox"/> S-Video 1	<input checked="" type="checkbox"/> S-Video 2

OSD Display Setting	
OSD func.	ON ▾
OSD info.	ON ▾

HDMI
HDBaseT

Video Settings	
Scale	Follow Input ▾
BNR	Medium ▾
MNR	Medium ▾
RNR	Medium ▾
Contrast	50 
Brightness	50 
Sharpness	15 
Color	50 
Tint	0 
H Position	15 
Phase	0 

VGA/Component/Composite/S-Video

Factory Default

Video Settings

Set the output video settings:

Scale - Sets video output aspect ratio - Full, overscan, letter box, pan and scan, or follow input

Full - Sources always fill the screen, regardless of source aspect ratio

Overscan - Image is slightly zoomed in so that broadcast data at edges is masked

LetterBox - Used to create 16:9 aspect ratio on 4:3 aspect ratio TVs

Pan and Scan - Used to create 4:3 aspect ratio on 16:9 aspect ratio TVs

Follow Input - Aspect ratio on TV matches source aspect ratio

BNR - Block noise reduction - Disabled, low, medium, or high

MNR - Mosquito noise reduction - Disabled, low, medium, or high

RNR - Random noise reduction - Disabled, low, medium, or high

Contrast* - Sets output white levels - 0 up to 100

Brightness* - Sets output black levels - 0 up to 100

Sharpness* - Sets output sharpness - 0 up to 30

Color* - Sets output color saturation - 0 up to 100

Tint* - Sets output hues - 0 up to 100

H Position* - Sets the horizontal position of the output video

Phase* - Adjusts digital sample timing to minimize image noise

*Only available when inputs 5 and 6 (VGA 1 & VGA 2) are selected

Poll Settings	
<input checked="" type="checkbox"/> VGA 1	<input checked="" type="checkbox"/> VGA 2
<input type="checkbox"/> Component 1	<input type="checkbox"/> Component 2
<input type="checkbox"/> Composite 1	<input type="checkbox"/> Composite 2
<input checked="" type="checkbox"/> S-Video 1	<input checked="" type="checkbox"/> S-Video 2

Poll Settings

Turn analog input options on and off. If a selection is unchecked it will not display as an input option when switching to input 5 or 6.

e.g. In the above picture, only VGA and S-Video would show as a source option

Note: Component, composite, and S-Video poll settings will grey out when VGA auto switching is on

OSD Display Setting	
OSD func.	ON ▾
OSD info.	ON ▾

OSD Display Settings

OSD func - Turns the CLSO's display OSD menu on/off

OSD info - Turns the source information on the display on/off when switching

Factory Default

It will reset parameters.

Confirm Cancel

Factory Default

Select to reset CLSO back to factory settings.

Note: This will reset the switcher to factory default, including resolutions, audio settings, HDCP settings, etc.



AT-UHD-CLSO-612ED Config

Home Network Setup Settings **Config** EDID Audio Control HDVS Update

Change user name and password:

Old user name and password	
Username	<input type="text" value="root"/>
Password	<input type="password"/>
New user name and password	
Username	<input type="text"/>
Password	<input type="password"/>
PW again	<input type="password"/>

No.	Username	Password	Delete
User 1			Delete
User 2			Delete
User 3			Delete

RS232	Baudrate	Databit	Parity	Stopbit
System	115200	8 Bits	None	1 Bit
Input1	9600	8 Bits	None	1 Bit
Input2	9600	8 Bits	None	1 Bit
Input3	9600	8 Bits	None	1 Bit
Input4	9600	8 Bits	None	1 Bit
Input5	9600	8 Bits	None	1 Bit
Input6	9600	8 Bits	None	1 Bit
Output1	9600	8 Bits	None	1 Bit
Output2	9600	8 Bits	None	1 Bit

Factory Default

The config page will allow the admin password to be changed, users to be added, and the RS-232 ports to be configured (both CLSO-612ED system ports and the RS-232 I/O ports accessed through the analog RS-232 interfaces and HDBaseT connections).

Note: User information will display for the admin only.

Note: Only the admin password can be changed. The admin username will always remain "root". If the admin password is lost the system must be returned to factory settings and setup repeated.

Prefer Timing(HDMI):	<input type="text" value="Default"/>
Prefer Timing(VGA):	<input type="text" value="Default"/>
Input1 HDCP:	<input type="text" value="Compliant"/>
Input2 HDCP:	<input type="text" value="Compliant"/>
Input3 HDCP:	<input type="text" value="Compliant"/>
Input4 HDCP:	<input type="text" value="Compliant"/>

The EDID page enables the input preferred timing to be selected and HDCP compliance reporting to be set. This function is controllable through RS-232 as well.





- Note:** CLSO-612ED protects HDCP encoded content and will not pass HDCP content to a non-HDCP compliant device.
- Note:** Some devices flag all content as protected when connected to an HDCP compliant display. This prevents what should be non-protected content from reaching devices (**i.e.** teleconference system) through the CLSO-612ED.
- Note:** When HDCP reporting is non-compliant, only user created content is transmitted. Protected content from all sources (**e.g.** BluRay, AppleTV, etc) is blocked.

Volume Settings		
Master	0 dB	
HDMI 1	0 dB	
HDMI 2	10 dB	
HDBT 1	0 dB	
HDBT 2	0 dB	
Analog 1	0 dB	
Analog 2	0 dB	
Microphone	-80 dB	
Line In	0 dB	
Bass	-10 dB	
Treble	12 dB	

Ducking Settings		
Microphone	<input type="text" value="ON"/>	
Attack Time	400 ms	
Release Time	1500 ms	
Trig Level	-35 dB	
Program Decrease	30 dB	

Audio settings adjust output volume for all sources including the microphone.
 Master - Affects all sources at the same time
 Inputs - Used to balance levels from each source.

Note: For best results, gains should be balanced between master and source levels.

Ducking Settings			
Microphone	ON		
Attack Time	400 ms		
Release Time	1500 ms		
Trig Level	-35 dB		
Program Decrease	30 dB		

Microphone ducking uses the audio level from the microphone to decrease the program level so the speaker may be heard.

Note: Proper set up is critical for satisfactory operation. If program levels are too high they can trigger the ducking process.

Note: Setting the microphone volume too high may result in feedback.

It is recommended that a handheld or headset microphone be used with ducking to reduce feedback and maximize the difference between voice and program levels.

Best results are received with the following sequence:

1. Set master volume to 0. (This is 10 db below maximum)
2. Raise appropriate microphone (or line in) volume until just below feedback or adequate volume is reached (whichever setting is lower). - Master level and amplifier gains may be increased to get appropriate levels
 - Note:** If feedback occurs and volume is not adequate, move the speakers and/or microphone to eliminate feedback.
3. Raise source "sub" volumes to appropriate levels without talking
4. Set attack time to minimize popping, but still fast enough that initial talking sounds are heard.
5. Set release time so that program levels do not increase between sentences.
 - Note:** Shorten time so that the microphone doesn't interfere with the program.
6. Set the trigger level so that words spoken at a normal level trigger the ducking process
 - Note:** Set the trigger level too sensitive and the program will trigger the ducking. Set too low and the speaker will have to talk very loudly to trigger ducking. The further right the slider is, the more sensitive the setting.
7. Set program decrease to ensure when ducking is triggered the program level is low enough the speaker can be heard.

Fine tuning these settings will help achieve the best results.

Button Control Selection	
Power	None ▾
Volume/Mute	Audio Out ▾
Display Mode	DispSW AVon ▾

CEC Control	
Power	<input type="button" value="on"/> <input type="button" value="off"/>

The Control Page includes settings which enable display controls by the switcher. It provides a way to program button functions, turn auto switching on/off, and determine the type of control commands (TCP/IP or RS-232) sent out.

Button Control Selection

Power - Set which device the power button controls

None: Power button will turn the UHD-CLSO-601 on and off

RS-232: Power button will send power on/off command over HDBaseT using RS-232 to compatible receivers and displays

IP: Power button will send power on/off command over Ethernet using either the LAN connection or the HDBaseT connection

CEC: Sends CEC command over HDBaseT to the HDMI output of the receiver

Volume/Mute

Audio Out: Volume and mute buttons will control volume output of the switcher

RS-232: Volume/Mute buttons will send the commands over HDBaseT or RS-232 zone 7, using RS-232 to compatible receivers and displays

IP: Volume/Mute buttons will send the commands over Ethernet using either the LAN connection or the HDBaseT connection

Display Mode - Sets functionality of the power button

DispSW AVon: Display switches on/off, source audio/video signal always on

DispSW AVSW: Display switches on/off, source audio/video signal switches on/off

AV SW: Display is always on, source audio/video signal switches on/off

Always ON: No function

Note: Must be in DispSW AVon or DispSW AVSW for RS-232 display control to work

CEC Control

Power

On - Sends a command over HDBaseT to the HDMI output of the connected receiver to turn the connected display on

Off - Sends a command over HDBaseT to the HDMI output of the connected receiver to turn the connected display off

Note: CEC may not work with every display type. See notice at the bottom of page 3 for more information.

System Settings		
Display Auto Power On	Enabled	Disabled
Display Auto Power Off	Enabled	Disabled
Power Button Lock	Enabled	Disabled
Lamp Cool Down Timer (0~300)	0 Sec	Save
Auto Power Off Timer (1~240)	10 Sec	Save
Display Warm Up Timer (0~300)	0 Sec	Save
Control Type	RS-232	▼
Feedback Verify	ON	▼
Display Mode	DispSW AVon	▼

System Settings

Display Auto Power On - When enabled, the unit will send a programmed command to the display to turn on after detecting an A/V signal

Display Auto Power Off - When enabled, the unit will send a command to the display to turn off after not detecting an A/V signal

Lamp Cool Down Timer (0-300) - Used with a projector whose lamp cannot be turned on for up to 5 minutes after being shut off. Match settings with lamp delay on projector

Auto Power Off Timer (1-240) - Sets the period of time between the loss of A/V signal and when the "Display Off" command is sent

Note: LED will blink red for the auto power off time period then go solid

Note: All functionality remains, only the HDBaseT output is turned off

Display Warm Up Timer (0-300) - Sets the period of time after the display is turned on, that the power button will be locked

Note: LED will blink green for the warm up timer period and then stay solid

Note: When timers are set to 0 seconds, they will disable the timers' functions

Control Type - Select whether the display on/off commands are sent using RS-232, TCP/IP, or CEC

Feedback Verify

On: If receiving no feedback, the product will send the command up to 4 times

Off: The command will only be sent once, whether feedback is received or not

Display Mode -

DispSW AVon: Display switches on/off, source audio/video signal always on

DispSW AVSW: Display switches on/off, source audio/video signal switches on/off

AV SW: Display is always on, source audio/video signal switches on/off

Note: Must be in DispSW AVon or DispSW AVSW for RS-232 display control to work

TCP/IP Settings of Controlled Device	
IP Mode	Non-Login <input type="button" value="Save"/>
IP Address	192.168.0.85 <small>Please set your device to static IP address.</small>
Port	23
Username	username
Password	password

RS-232/IP Commands	
<input checked="" type="radio"/> ASCII <input type="radio"/> Hex	<input type="button" value="Save"/>
<input type="button" value="Test"/> On	
PW 1	None ▾
Feedback	
PW 1	None ▾
<input type="button" value="Test"/> Off	
PW 0	None ▾
Feedback	
PW 0	None ▾
<input type="button" value="Test"/> Volume+	
VOL+	None ▾
<input type="button" value="Test"/> Volume-	
VOL-	None ▾
<input type="button" value="Test"/> Mute	
MUTE	None ▾
Feedback	
MUTE	None ▾

TCP/IP Settings of Controlled Device

This option sets the IP for display control. The static IP set here should match the display's static IP. To set or view the display's IP address, check the display's user manual.

Note: The switcher and the display must be on the same network for these commands to work

Note: Be sure the static IP address set for the display does not match any other device on the network

IP Mode

Non-login: Does not require a username and password when using TCP/IP to control the display

Login: Requires a username and password to control the display through TCP/IP

IP Address & Port - Set to match the display's static IP

Username & Password - Required when in login mode

Save - Saves the IP settings for accessing the controlled device

RS-232/IP Commands

ASCII/Hex - Set which type of commands are sent to the display

On/Off/Volume+/Volume-/Mute - Enter the specific commands and feedback that will be sent/received when using any of the control options

Note: Individual commands will be found in the display's manual

End of line symbols - None, CR, LF, CR-LF, Space, STX, ETX, Null - Select the appropriate symbol from the drop down list. Carriage return, line feed, and carriage return with line feed are the most commonly used symbols.

Note: Be sure to check the display's manual for the correct symbol

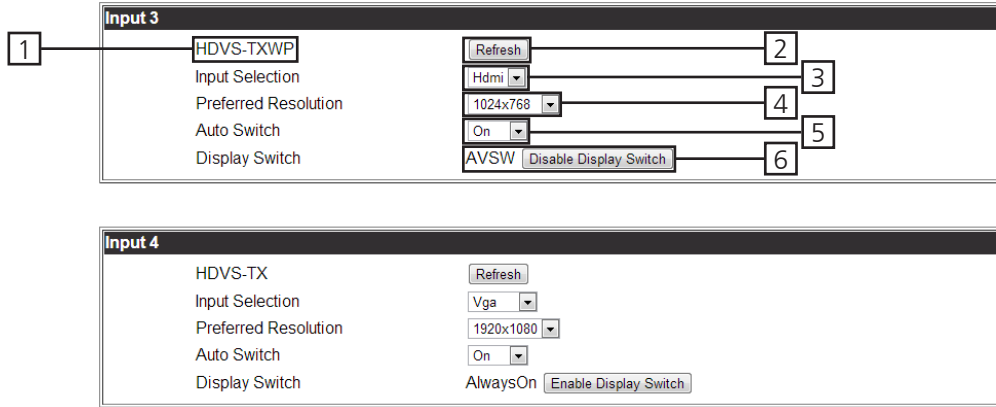

1. Displays model number of connected HDVS transmitter
2. Refresh button - Ensures the correct and current settings are displayed
3. Input selection - Switch between the HDVS inputs
4. Preferred resolution - Sets the HDVS VGA port preferred input resolution
5. Auto switch - Turns auto switching on/off for the HDVS transmitter
6. Display switch - Sets display switch function of the HDVS (default is disabled)
 Recommended set to disabled - product will be always on

Firmware Update

No file selected.

0%

Valens Update

No file selected.

0%

Audio Update

No file selected.

0%

FPGA Update

No file selected.

0%

OSD Update

No file selected.

0%

The firmware page provides an area to update the switcher, Valens (HDBaseT), audio, FPGA, and OSD firmwares.

- Select the browse button for the type of firmware to be updated
 - Firmware Update - MCU/Main firmware
 - Valens Update - Valens firmware
 - Audio Update - DSP firmware
 - FPGA Update - FPGA firmware
 - OSD Update - OSD firmware
- Select the new firmware file that was downloaded either from atlona.com or box.com
- Press the update button

A progress bar will display as the update is completed. After the update is complete, if a restart is required, the webGUI will display a prompt. The firmware update is now complete and the switcher is ready to be used.

Note: Current firmware can be found at <http://www.atlona.com/product/AT-UHD-CLSO-612ED/> under the firmware tab.

IR

System IR is typically used to connect to control system processors. The signal is routed through the System IR IN and repeated to out all the IR OUT ports, including the HDBaseT ports. This input may also be used to control the CLSO-612ED.

Note: HDBaseT ports must be connected to HDBaseT receivers and transmitters with IR capabilities.
(e.g. AT-HDTX-IR, AT-HDTX-WP, AT-HDWP-IR, AT-HDRX-IR, etc)

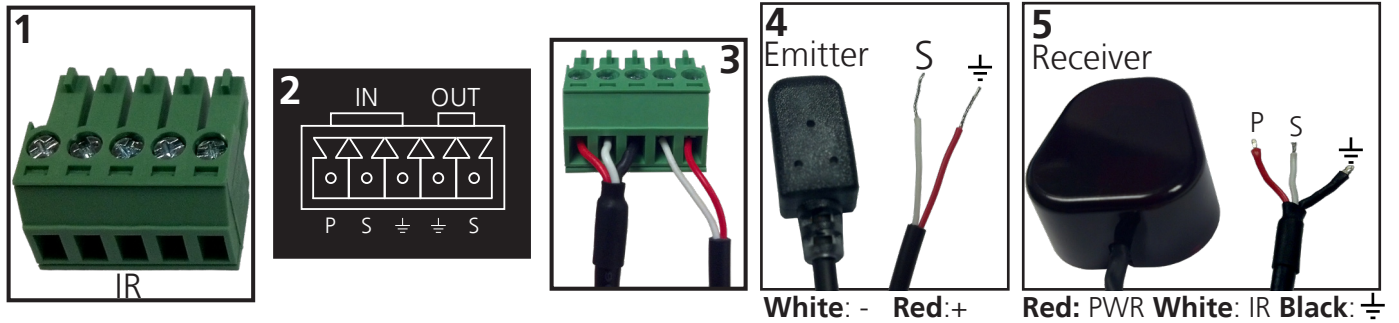

For your convenience the cables do not come pre-terminated. Each item, whether it's an IR receiver or IR emitter, will have wires exposed. Each wire is encased in a different colored cover. A female IR captive screw connector has been included (see picture 1).

IR pin outs have been included for the included IR emitter and IR receiver (see picture 2 & 3). The wires are colored for each pin (see picture 4 and 5).

Remote

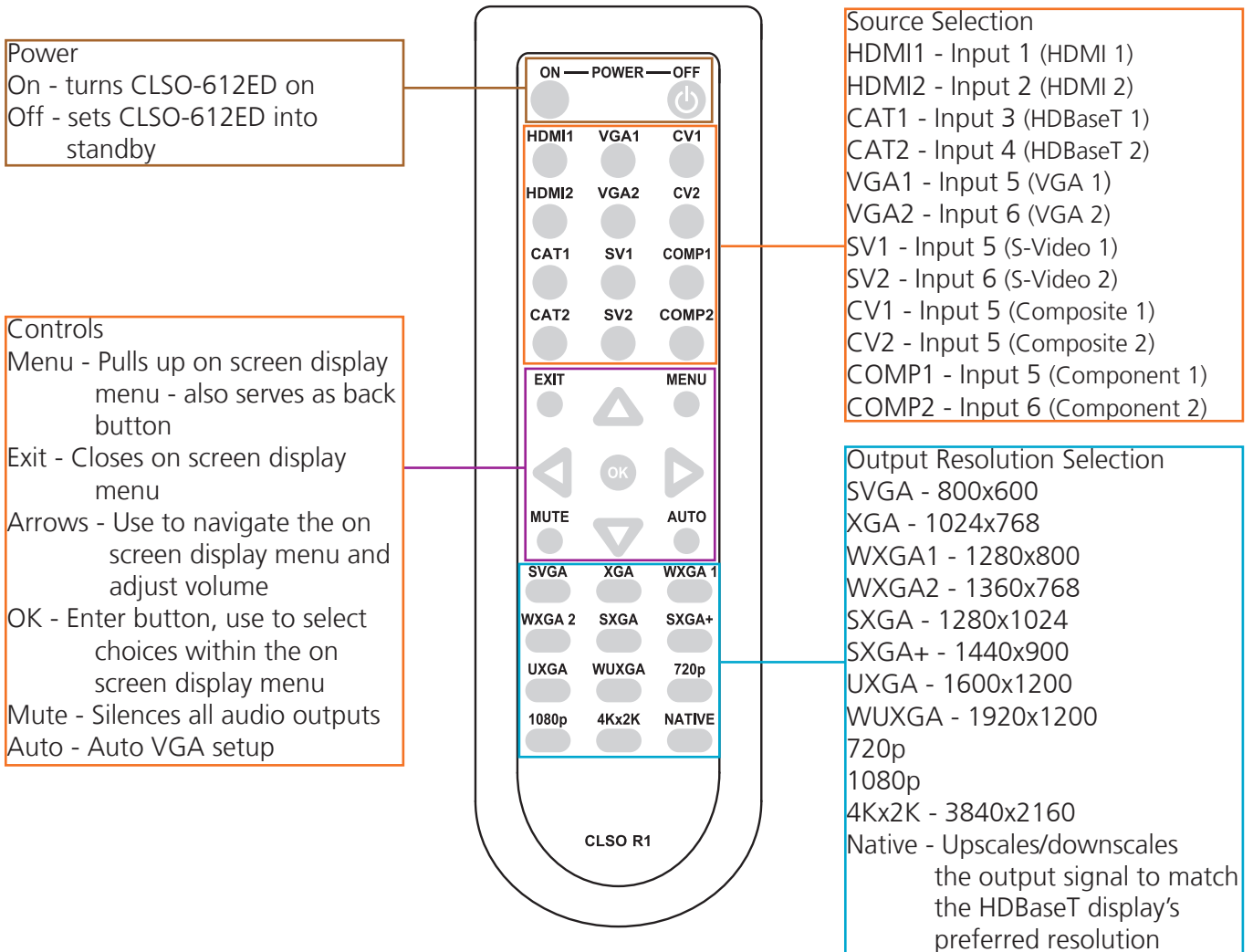

RS-232

Connection

RS-232 pin out will be determined by the RS-232 cable and will connect as Rx (receiver), Tx (transmitter), and \perp (ground). (See picture 1)

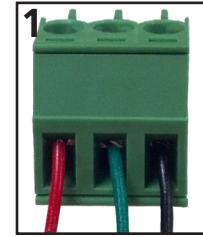
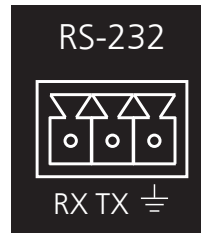

Wire color will differ by cable manufacturer.

RS-232 is often connected through a 9-pin D to captive screw connector. The pins will have functions associated with them, some will be unassigned.

Note: Typical DB9 connectors use pin 2 for TX, pin 3 for RX, and pin 5 for ground. On some devices functions of pins 2 and 3 are reversed.

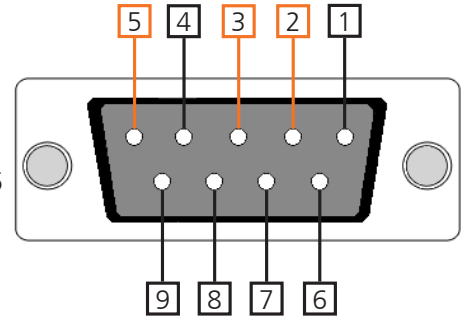

Set Up

To set up the RS-232 hyperterminal (if not using 3rd party software) use the following steps:

1. Connect the CLSO-612ED to a PC using a 3 pin to USB cable
2. Go to the Device manager folder (see picture A)
3. Find the CLSO-612ED COM port and right click with a mouse and select properties (see picture B)
 - Note:** If unsure which COM port is the CLSO-612ED, unplug the cable and plug it back in. It will disappear and reappear on the COM port list.
4. Under the properties menu select the port settings tab and update the menu to the **CLSO-612ED default settings of:** Bits Per Second: 115200, Data Bits: 8, Parity: None, Stop Bits: 1 and Flow Control: None. (see picture C)

Set up is done and any hyperterminal program may be used to control the CLSO-612ED now.

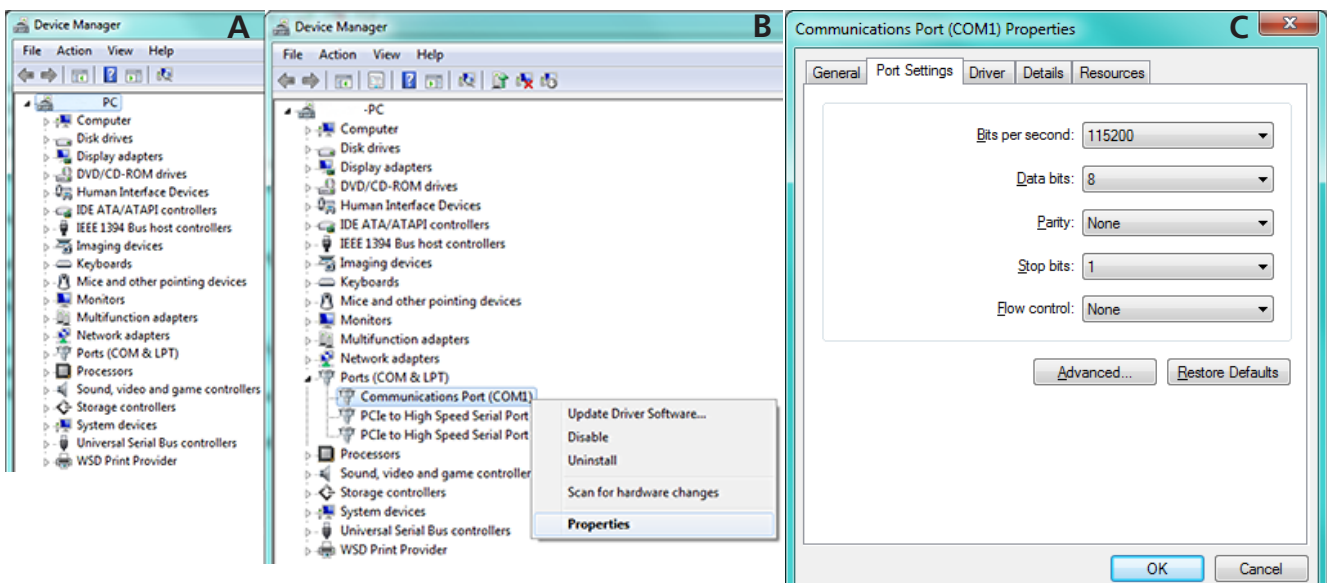

Commands

The command codes are case sensitive, do not change capitalization, spacing, or lettering.

Command	Feedback	Description
PWON	PWON	Power ON
PWOFF	PWOFF	Stand-by
PWSTA	PWON/PWOFF	Get system power status
RS232zone[X][Y]	RS232zoneX[Y]	RS232zoneX[Y], X: 1-8. Y is the command sent to the HDBT [Y] is the command string sent to the display device
RS232para[X][Y]	RS232paraX[Y]	RS232paraX[baudrate,databit,parity,stopbit] X is 1-8. [Y] is the parameter for RS232.
CSpara[Y]	CSpara[Y]	Set RS232 parameter [Y] is the parameter for RS-232.
VOL+	VOL(xx)	Turns the volume up one level
VOL-	VOL(xx)	Turns the volume down one level
VOL(xx)	VOL(xx) e.g. VOL(10)	Turns volume to the specified level <xx: 10 ~ -80> Read the volume current level status => VOL e.g. Adjusts the master volume level to -23dB => VOL(-23)
MVOL+	MVOL(xx)	Turns the MIC volume up one level
MVOL-	MVOL(xx)	Turns the MIC volume down one level
MVOL(xx)	MVOL(xx) ex. MVOL(30)	Turns MIC5V volume to the specified level <xx: 30 ~ -80> Read the MIC5V volume current level status => MVOL
MICx [Y]	MICx [Y] e.g. MICon 20	Sets up MIC values x = on / off / sta / atime (attack time) / rtime (background release time) / sens (microphone sensitivity level) / reduce (background reduce level) [Y] = value (e.g. 20)
LVOL+	LVOL(xx)	Turns the Line volume up one level
LVOL-	LVOL(xx)	Turns the Line volume down one level
LVOL(xx)	LVOL(xx) e.g. LVOL(0)	Turns Line volume to the specified level <xx: 0 ~ -80> Read the Line volume current level status => LVOL
SnVOL+	SnVOL(xx)	Turns the Sub volume up one level <n: 1-6> (n = input number) e.g. Adjusts the HDBT2 volume to up => S4VOL+
SnVOL-	SnVOL(xx)	Turns the Sub volume down one level <n: 1-6> (n = input number) e.g. Adjusts the VGA1 volume to down => S5VOL-
SnVOL(xx) e.g. S2VOL(-15)	SnVOL(xx) e.g. S2VOL(-15)	Turns Sub volume to the specified level <n: 1-6, xx: 0 ~ -80> (n = input number) Read the Sub volume current level status => SnVOL e.g. Adjusts the HDMI1 volume level to -10dB => S1VOL(-10)
VOLMute [Y]	VOLMute [Y]	VOLMute [on/off/sta]. Set volume to mute on. => VOLMute on
Menu[X]	Menu[X] e.g. MenuDown	Sets to control OSD interface, [X]: Sw/Up/Down/Left/Right/Info/Sel e.g. Select OSD option => MenuSel
Lock	Lock	Locks the front panel
Unlock	Unlock	Unlocks the front panel
Version [Y] e.g. Version osd	Version [Y] e.g. Version x.x.xx	Brings up the software versions: ex. Version mcu firmware [mcu] OSD menu [osd] DSP [dsp] FPGA [fpga]
Type	AT-UHD-CLSO-612	Brings up the model information
Mreset	Mreset	Reset device to manufacture default

Command	Feedback	Description
EQB+	EQB(xx)	Turns EQ bass up one level
EQB-	EQB(xx)	Turns EQ bass down one level
EQB(xx)	EQB(xx)	Turns EQ bass to the specific level xx: (xx: -10 to 12)
EQT+	EQT(xx)	Turns EQ treble up one level
EQT-	EQT(xx)	Turns EQ treble down one level
EQT(xx)	EQT(xx)	Turns EQ treble to the specific level xx: (xx: -10 to 12)
ManHPos+	ManHPos(xx)	Sets horizontal position one pixel to the right
ManHPos-	ManHPos(xx)	Sets horizontal position one pixel to the left
ManHPos(xx)	ManHPos(xx)	Sets horizontal position to a specific setting (xx: 0-40)
ManPha+	ManPha(xx)	Adjusts pixel phase up one level
ManPha-	ManPha(xx)	Adjusts pixel phase down one level
ManPha(xx)	ManPha(xx)	Adjusts pixel phase to a set amount (xx: 0 to 63)
VFmtRes [Y] e.g. VFmtRes 09	VFmtRes XX e.g. VFmtRes 09	Set output video format to any of the [Y] resolutions below e.g. Set output video format to 1080p@60 => VFmtRes 06 e.g. Read the list of video format => VFmtRes List

[Y] resolution list -

00 Pass-Through	01 640x480p60	02 720x480i60
03 720x480p60	04 1280x720p60	05 1920x1080i60
06 1920x1080p60	07 720x576i50	08 720x576p50
09 1280x720p50,	10 1920x1080i50	11 1920x1080p50
12 1920x1080p24	13 1920x1080p25	14 1920x1080p30
15 640x480p72	16 640x480p75	17 800x600p60
18 800x600p72	19 800x600p75	20 1024x768p60
21 1024x768p72	22 1024x768p75	23 1280x768p60
24 1280x800p60	25 1280x960p60	26 1280x1024p60
27 1360x768p60	28 1366x768p60	29 1440x900p60
30 1600x1200p60	31 1920x1200p60	32 2048x1080p24
33 2048x1080p50	34 2048x1080p60	35 2048x1152p60
36 3840x2160p24	37 3840x2160p25	38 3840x2160p30
39 4096x2160p24	40 4096x2160p30	41 1400x1050p60
42 1600x900p60	43 2560x1600p60	254 Native

SetCmd X[Y] e.g. SetCmd on[PWR ON]	SetCmd X[Y] e.g. SetCmd on[PWR ON]	Sets the RS-232 or IP command for the selected button or function X= on, off, vol+, vol-, and mute Y= command e.g. Set the on command to send the command PWR ON
SetEnd X[Y] e.g. SetEnd off[CR-LF]	SetEnd X[Y] e.g. SetEnd off[CR-LF]	Sets the line termination for the chosen command X= on, off, vol+, vol-, mute, fbkon, fbkoff, fbkmute Y= None, CR, LF, CR-LF, Space, STX, ETX, and null e.g. Set the command off to have a carriage return and line feed
SetFbVerify X e.g. SetFbVerify on	SetFbVerify X e.g. SetFbVerify on	Verifies the device is receiving commands X= on, off, sta e.g. Sends command up to 4 times until feedback verifies command was received with feedback
TrigCEC X e.g. TrigCEC on	TrigCEC X e.g. TrigCEC on	Triggers the stored CEC command to turn the display on and off X= on, off
TrigRS X e.g. TrigRS vol+	TrigRS X e.g. TrigRS vol+	Triggers the RS-232 command from RS-232 or IP X= on, off, vol+, vol-, and mute
TrigIP X e.g. TrigIP vol-	TrigIP X e.g. TrigIP vol-	Triggers the IP command from RS-232 or IP X= on, off, vol+, vol-, and mute
CtlType X e.g. CtlType rs-232	CtlType X e.g. CtlType rs-232	Sets the control type X= ip, rs-232, cec e.g. Set the control type to RS-232
CliMode X e.g. CliMode non-login	CliMode X e.g. CliMode non-login	Sets the control device's IP mode X= sta, login, non-login e.g. Sets the IP mode to non-login
CliUser X e.g. CliUser	CliUser X e.g. CliUser admin	Sets the IP username for login X= username, (blank) e.g. Display the IP username by leaving x blank
CliPass X e.g. CliPass AtlonA	CliPass X e.g. CliPass AtlonA	Sets the IP password for login X= password, (blank) e.g. Set the IP password to AtlonA
CliIPAddr X e.g. CliIPAddr sta	CliIPAddr X e.g. CliIPAddr 192.168.0.23	Sets the IP address of the controlled device X= ip, sta e.g. Display the IP address of the controlled device
CliPort X e.g. CliPort 24	CliPort X e.g. CliPort 24	Sets the IP port of the controlled device X= port, sta e.g. Set the IP port to 24
AutoDispOff X	AutoDispOff X	Enable or disable display auto off X= on, off, sta
AutoDispOn X	AutoDispOn X	Enable or disable display auto on X= on, off, sta
APwrOffTime X	APwrOffTime X	Sets how long after receiving no signal to trigger auto display off X= 1-240, sta
ProjSWMode X	ProjSWMode X	Set delay time for the display on command to be sent X= 0-300, sta Note: Match the timing to the projector's delay settings
ProjWarmUpT X	ProjWarmUpT X	Set period of time after the display is turned on that the power command will not send X= 0-300, sta
VolKeyOPT X	VolKeyOPT X	Set the control type/device the volume button sends out X= 0-2
DispRS X	DispRS X	Sets the display command type to RS-232 X= on, off, sta
DispCEC X	DispCEC X	Sets the display command type to CEC X= on, off, sta
DispIP X	DispIP X	Sets the display command type to TCP/IP X= on, off, sta

Each command is terminated with a carriage return.
 Feedback is terminated with a carriage return and line feed.

Note: If the command fails or is incorrect the feedback should be "Command FAILED"

Volume Key

0 HDVS **1** RS-232 **2** IP

Display Key

0 HDVS **1** RS-232 **2** CEC **3** IP

Command	Feedback	Description
Input [X] [Y]	Input [X] [Y] Input HDBT 2	Input [interface]* [index]*. Select input source video. e.g. Select input to HDBT 2 video => Input HDBT 2
HDCPSetX [Y] ex. HDCPSet2 off	HDCPSetX Y ex. HDCPSet2 off	Sets HDCP mode of the HDMI ports X = 1 / 2 / 3 / 4 Y = on / off / sta
PrefTimng [X]	PrefTimng [X]	Set preferred timing to EDID. X is 1-10 & sta
VGAPrefT [X]	VGAPrefT [X]	Set preferred VGA timing to EDID. X is 1-8 & sta
BNR [Y]	BNR [Y]	BNR [off/low/medium/high/sta]. Configure video block noise reduction
MNR [Y]	MNR [Y]	MNR [off/low/medium/high/sta]. Configure video mosquito noise reduction
RNR [Y]	RNR [Y]	RNR [off/low/medium/high/sta]. Configure video random noise reduction
PollAddInX [Y]	PollAddInX [Y]	PollAddInX [VGA/COMP/CV/SV]. Add source of analog polling. X = 1 (VGA input 5) or 2 (VGA input 6). Ex: PollAddIn2 SV allows enabling of SV for VGA input 5.
PollDelInX [Y]	PollDelIn [Y]	PollDelInX [VGA/COMP/CV/SV]. Delete source of analog polling. X = 1 (VGA input 5) or 2 (VGA input 6). Ex: PollDelIn VGA,CV,COMP will delete VGA & CV & COMP
OSD [Y]		OSD [func/logo/info][on/off/sta]
Aspect [Y]	Aspect [Y]	Aspect [full/overscan/underscan/letterbox/panscan/follow/sta] Sets video aspect function
OutAMute [Y]	OutAMute [Y]	OutAMute [on/off/sta] Sets output audio mute of HDMI and HDBT
AUD In[X] Ai[Y]	AUD In[X] Ai[Y]	AUD In[X] Ai[Y] x: 1-6 Y: 5-6 or P Replaces the selected input's audio with the selected analog input (5 or 6) or sets it to pass through (p) normally e.g. Replace input 2's audio with analog 6 - Aud In2 Ai6 e.g. Pass through input 3's audio normally - Aud In3 AiP
AutoSW [Y]	AutoSW [Y]	AutoSW [on/off/sta/VGAon/VGAoff/VGAsta] Sets auto switch mode status Factory Default: Sets auto switch to on with VGA auto switch to off
ASwPrePort [Y]	ASwPrePort [Y]	ASwPrePort [HDMI1/HDMI2/HDBT1/HDBT2/Previous] Sets default auto switch port or sets to previous input
ASwOutTime [Y]	ASwOutTime [Y]	ASwOutTime [sec] Sec: 1-600 (default is 1 second) Sets the delay time for how long the auto switching receives no signal from the input before switching ports e.g. Sets the auto switching delay time to 1 minute with no signal before changing ports - ASwOutTime60

[Interface] index -

HDMI 1	HDMI 2	HDBT 1
HDBT 2	COMP 1	COMP 2
CVBS 1	CVBS 2	SVIDEO 1
SVIDEO 2	VGA 1	VGA 2

[X] preferred timing -

1 1280x800	2 1920x1080	3 1024x768
4 1280x720	5 1920x1200	6 1366x768
7 800x600	8 1600x900	9 2560x440
10 3840x2160	sta Read status	

VGA [X] preferred timing -

1 1280x800	2 1920x1080	3 1024x768
4 1280x720	5 1920x1200	6 1366x768
7 800x600	8 1600x900	sta Read status

IP Commands

Command	Feedback	Description
IPCFG	IP Addr : x.x.x.x Netmask : x.x.x.x Gateway : x.x.x.x IP Port : x	Displays IP address configure
IPQuit	IPQuit	Telnet Logout
IPAddUser [X] [Y]	IPAddUser [X] [Y]	IPAddUser [name] [password]. Add user of telnet. If only command write "IPAddUser", it will display all user list. => IPAddUser
IPDelUser [Y]	IPDelUser [Y]	IPDelUser [name]. Del user of telnet
IPDHCP [Y]	IPDHCP [Y]	IPDHCP [on/off/sta]. Set DHCP mode status and auto reset telnet. e.g. Set DHCP mode is on => IPDHCP on
IPStatic [X] [Y] [Z]	IPStatic [X] [Y] [Z]	IPStatic [Address] [Netmask] [Gateway]. Set static IP address and auto reset telnet. e.g. Set static IP address is 192.168.1.1 255.255.255.0 192.168.1.254 => IPStatic 192.168.1.1 255.255.255.0 192.168.1.254
IPPort [Y]	IPPort [Y]	IPPort [port]. Set telnet port and auto reset telnet e.g. Set telnet port 80 => IPPort 80
IPLogin [Y]	IPLogin [Y]	IPLogin [on/off/sta]. Set telnet login status. e.g. Set telnet login is on => IPLogin on
Broadcast [Y]	Broadcast [Y]	Broadcast [on/off/sta]. Broadcast switch. e.g. Set broadcast mode is on => Broadcast on
IPTimeout [Y]	IPTimeout [Y]	IPTimeout [Sec]. Set telnet idle timeout time. Default is 2 minute. e.g. Set telnet idle timeout 10 minutes => IPTimeout 600

Each command must be terminated with a carriage return and line feed.

Feedback is terminated with a carriage return and line feed.

Note: If the command fails or is incorrect the feedback should be "Command FAILED"

Baud Rate

Zone RS-232 port configuration must match the connected device on all parameters including baud rate, data-length, parity, and stop-bit. These parameters can easily be set using the WebGUI or following commands through RS-232 or TCP/IP.

The baud rate for the switcher is for switcher control and the transmitter/receiver baud rate is for control of the RS-232 device in zone. All commands from your control processor are at the settings for the switcher. The switcher will modify the baud rate and other settings to these set parameters by zone.

Note: Baud rate options 2400, 4800, 9600, 19200, 38400, 57600, or 115200

Command for Switcher Parameters

CSpara[baudrate,data-length,parity,stop-bit] (data, parity, and stop bit for switcher must be 8,0,1)

For example if you wish to change the baud rate of the switcher to 38400 the command would look like this:

CSpara[38400,8,0,1]

Note: Default for the switcher is: Baud rate-115200bps, Data length-8bit, Parity-None, Stop Bit-1

RS-232 Command for the Output baud rate status

RS232para

The RS-232 status command will provide feedback for the current parameters for each transmitter/receiver. There are eight RS-232 zones:

- RS-232 zone 1 and 2 are dedicated to the HDMI Inputs 1 and 2
- RS-232 zone 3 and 4 are HDBaseT Inputs 3 and 4
- RS-232 zone 5 and 6 are dedicated to RG15 inputs 5 and 6
- RS-232 zone 7 is dedicated to HDMI Output
- RS-232 zone 8 is HDBaseT Output

Example: (See example of feedback below)

RS232para

Current RS232 parameter:

- Zone 1 :BaudRate 2400bps, DataBits 0, Parity None, StopBits 1.
- Zone 2 :BaudRate 9600bps, DataBits 0, Parity ODD, StopBits 1.
- Zone 3 :BaudRate 9600bps, DataBits 0, Parity None, StopBits 1.

Note: Zone 3 is HDBaseT 1, zone 4 is HDBaseT 2, and zone 8 is HDBaseT output.

Note: Default for the transmitters/receivers is: Baud-9600bps, Data length-8bit, Parity-None, Stop Bit-1

Control Diagram

- Video
- HDBaseT
- Control

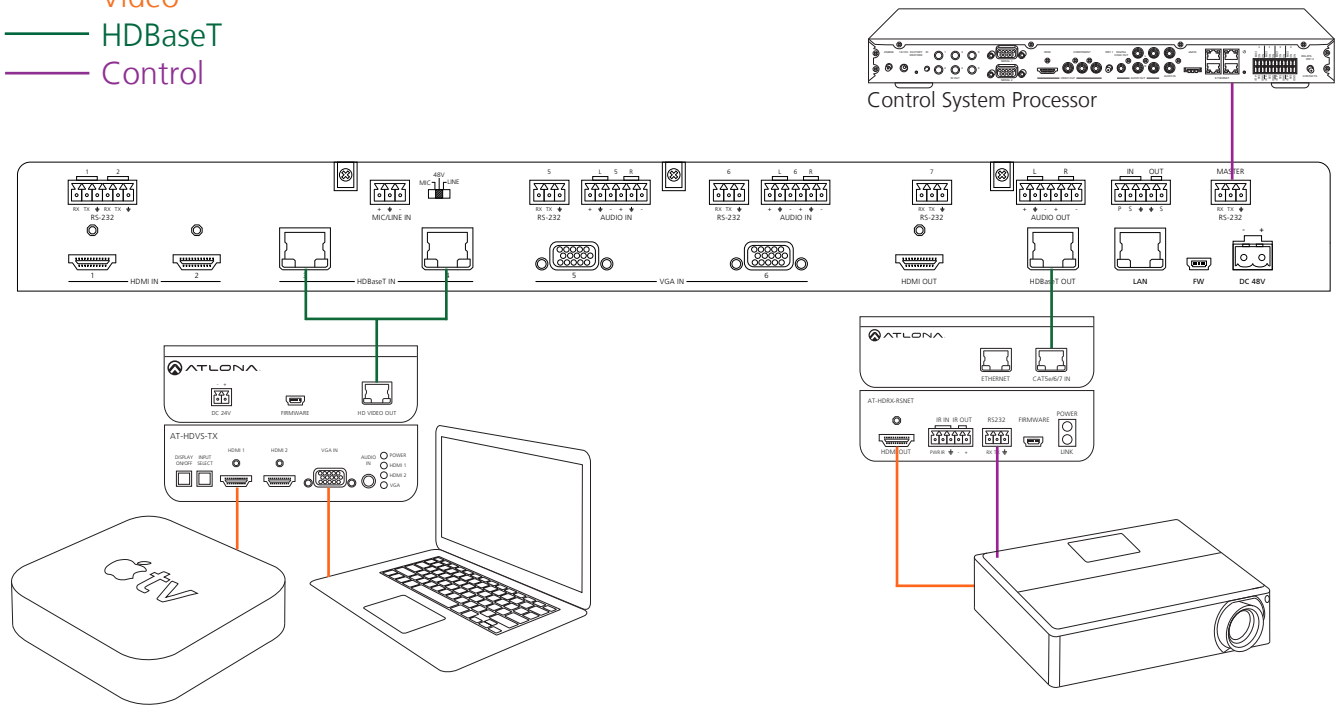

Use RS-232 commands to select inputs on AT-HDVS-TX

Connection and Installation

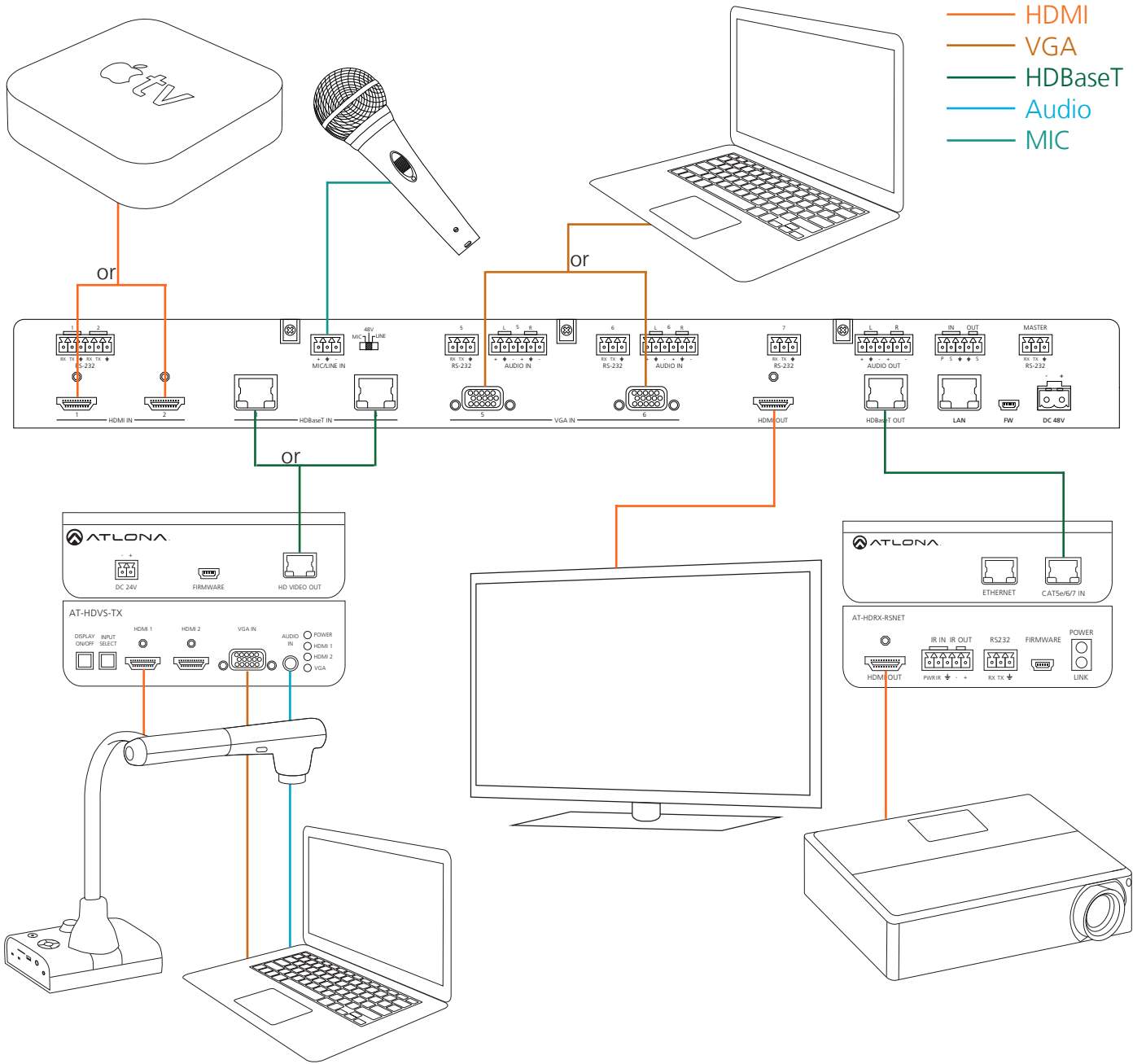

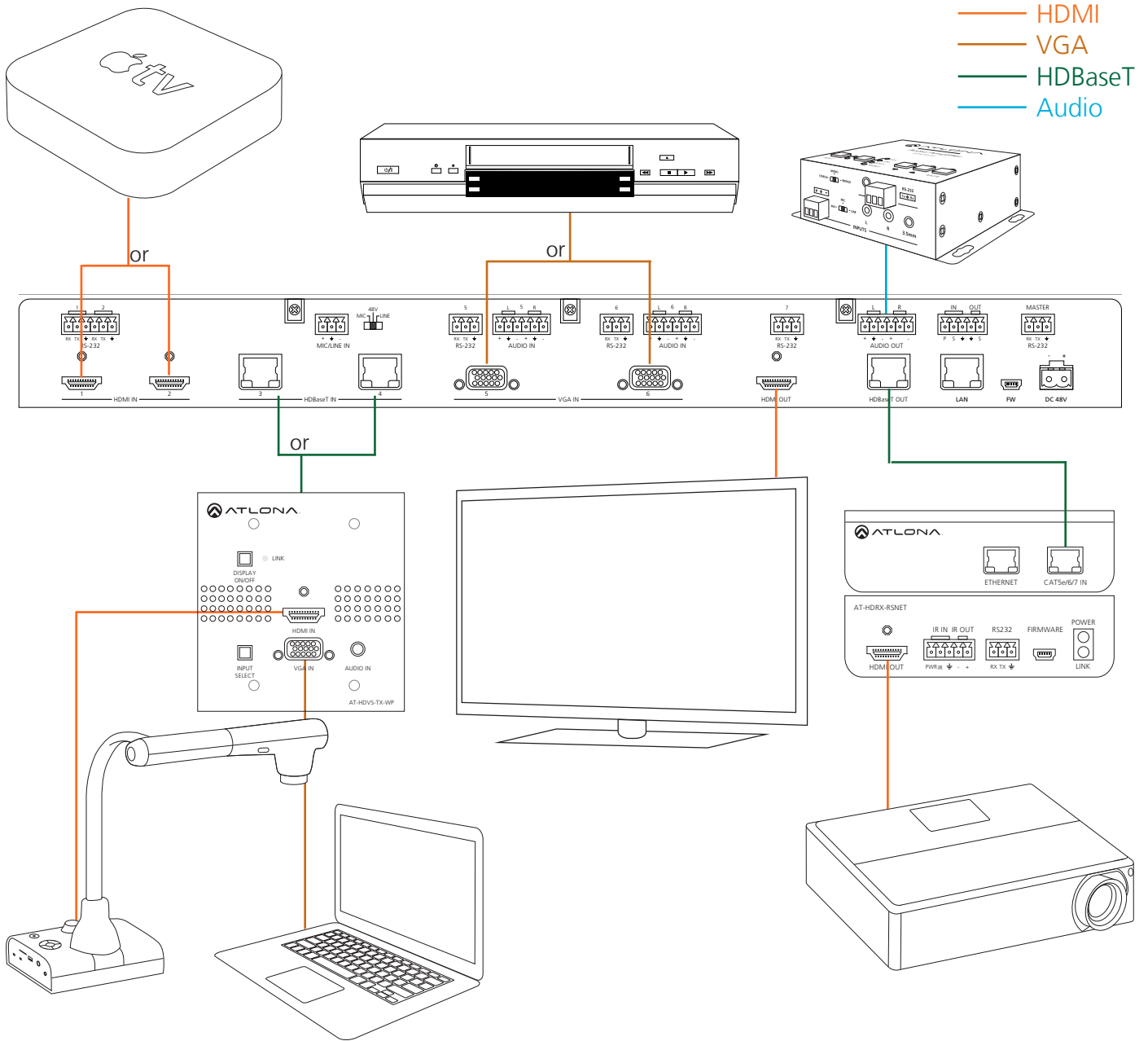

Control Drivers

Visit the **Control Drivers** tab at <http://www.atlona.com/AT-UHD-CLSO-612ED.html> to download the control drivers for the CLSO-612ED.

CLSO-612 Updating

Visit the **Firmware Update** tab at <http://www.atlona.com/AT-UHD-CLSO-612ED.html> to download the current updates for the CLSO-612ED.

Note: Atlona is constantly improving and updating features and stability. It is recommended that you check to make sure you are on the most current firmware before installation, especially when using a control system.

Specifications

Video Resolutions

IN	4096x2160@24/25/30, 3840x2160@24/25/30 (UHD), 2048x1080p, 1080p@23.98/24/25/29.97/30/50/59.94/60Hz, 1080i@50/59.94/60Hz, 720p@50/59.94/60Hz, 576p, 576i, 480p, 480i 2560x2048, 2560x1600, 2048x1536, 1920x1200, 1680x1050, 1600x1200, 1600x900, 1440x900, 1400x1050, 1366x768, 1360x768, 1280x1024, 1280x800, 1280x768, 1152x768, 1024x768, 800x600, 640x480
OUT	4096x2160@24/25/30, 3840x2160@24/25/30 (UHD), 2048x1080p, 1080p@23.98/24/25/29.97/30/50/59.94/60Hz, 1080i@50/59.94/60Hz, 720p@50/59.94/60Hz, 576p, 576i, 480p, 480i 2560x2048, 2560x1600, 2048x1536, 1920x1200, 1680x1050, 1600x1200, 1600x900, 1440x900, 1400x1050, 1366x768, 1360x768, 1280x1024, 1280x800, 1280x768, 1152x768, 1024x768, 800x600, 640x480
Composite/S-Video	NTSC, NTSC4, PAL, PAL-M, PAL-N, SECAM
Colorspace	YUV, RGB
Chroma Subsampling	4:4:4, 4:2:2, 4:2:0 (UHD only)
Color depth	8-bit, 10-bit, 12-bit
Nominal Level	<u>Composite</u> : (1 Vp-p), <u>S-Video</u> : Y(1Vp-p) - C(0.3 Vp-p) <u>Component</u> : Y(1Vp-p) - Pb(0.7 Vp-p) - Pr(0.7 Vp-p), <u>VGA</u> : R(0.7 Vp-p) - G(0.7 Vp-p) - B(0.7 Vp-p)
Min/Max levels	<u>Analog</u> : 0.0V to 1.0 Vp-p wit no offset at unity gain
Impedance	75 ohms
Horizontal Frequency	15kHz to 100kHz
Vertical Frequency	24Hz to 120Hz

Audio

Analog Output	PCM 2Ch (de-embedded)
HDMI/HDBaseT Output	PCM 2Ch, LPCM 5.1, LPCM 7.1, Dolby Digital, DTS 5.1, Dolby Digital Plus, Dolby TrueHD, DTS-HD Master Audio, Dolby Atmos, DTS:X
Frequency Response	20Hz to 20KHz ±1db
THD + Noise	<0.01%, 20Hz to 20kHz at nominal level
S/N	≤ -68dB @ 1kHz, fully loaded
Bass	+15dB to -12dB @ 250Hz
Treble	+15dB to -12dB @ 3kHz

Distance

CAT5e/6 @ 4K	up to 70M	up to 230 ft
CAT6a/7 @ 4K	up to 100M	up to 328 ft
CAT5e/6 @ 1080p	up to 100M	up to 328 ft
HDMI IN/OUT @ 4K	up to 5M	up to 15 ft
HDMI IN/OUT @ 1080p	up to 10M	up to 30 ft

Signal

Bandwidth	10.2 Gbps
CEC	Compliant
HDCP	Switchable - Compliant / Non compliant - 1.4

Temperature

Operating	0°C to 50°C	32°F to 122°F
Storage	-20°C to 60°C	-4°F to 140°F
Humidity	20 to 90% non-condensing	

Power

Consumption	43W
Idle Consumption	4W
Supply	Input: AC100-240V ~ 50/60Hz Output: DC 48V/3.125A

Dimension

H x W x D	44 x 438 x 254 (mm)	1.73 x 17.24 x 10 (inch)
Rack Unit	1U	

Weight

Device	3.22 kg	7.10 lbs
--------	---------	----------

Certification

Unit	CE, FCC	
Power Supply	CE, FCC, Level VI, RoHS, cULus, RCM, CCC	

Safety Information

Safeguards



To reduce the risk of electric shock, do not expose this product to rain or moisture



Do not modify the wall plug. Doing so will void the warranty and safety features.



If the wall plug does not fit into your local power socket, hire an electrician to replace your obsolete socket.



This equipment should be installed near the socket outlet and the device should be easily accessible in the case it requires disconnection.

Precautions

FCC regulations state that any unauthorized changes or modifications to this equipment, not expressly approved by the manufacturer, could void the user's authority to operate this equipment.

Operate this product using only the included external power supply. Use of other power supplies could impair performance, damage the product, or cause fires.

In the event of an electrostatic discharge this device may automatically turn off. If this occurs, unplug the device and plug it back in.

Protect and route power cords so they will not be stepped on or pinched by anything placed on or against them. Be especially careful of plug-ins or cord exit points from this product.

Avoid excessive humidity, sudden temperature changes or temperature extremes.

Keep this product away from wet locations such as bathtubs, sinks, laundries, wet basements, fish tanks, and swimming pools.

Use only accessories recommended by Atlona to avoid fire, shock, or other hazards.

Unplug the product before cleaning. Use a damp cloth for cleaning and not cleaning fluid or aerosols. Such products could enter the unit and cause damage, fire, or electric shock. Some substances may also mar the finish of the product.

Never open, remove unit panels, or make any adjustments not described in this manual. Attempting to do so could expose you to dangerous electrical shock or other hazards. It may also cause damage to your product. Opening the product will void the warranty.

Do not attempt to service the unit. Disconnect the product and contact your authorized Atlona reseller or contact Atlona directly.

Atlona, Inc. ("Atlona") Limited Product Warranty Policy

Coverage

Atlona warrants its products will substantially perform to their published specifications and will be free from defects in materials and workmanship under normal use, conditions and service.

Under its Limited Product Warranty, Atlona, at its sole discretion, will either:

- A) repair or facilitate the repair of defective products within a reasonable period of time, restore products to their proper operating condition and return defective products free of any charge for necessary parts, labor and shipping
- OR**
- B) replace and return, free of charge, any defective products with direct replacement or with similar products deemed by Atlona to perform substantially the same function as the original products
- OR**
- C) refund the pro-rated value based on the remaining term of the warranty period, not to exceed MSRP, in cases where products are beyond repair and/or no direct or substantially similar replacement products exist.

Repair, replacement or refund of Atlona's products is the purchaser's exclusive remedy and Atlona's liability does not extend to any other damages, incidental, consequential or otherwise.

This Limited Product Warranty extends to the original end-user purchaser of Atlona's products and is non-transferrable to any subsequent purchaser(s) or owner(s) of these products.

Coverage Periods

Atlona's Limited Product Warranty Period begins on the date of purchase by the end-purchaser. The date contained on the end-purchaser's sales or delivery receipt is the proof purchase date.

Limited Product Warranty Terms – New Products

- 10 years from proof of purchase date for hardware/electronics products purchased on or after June 1, 2013
- 3 years from proof of purchase date for hardware/electronics products purchased before June 1, 2013
- Lifetime Limited Product Warranty for all cable products

Limited Product Warranty Terms – Refurbished (B-Stock) Products and Discontinued Products

- 3 years from proof of purchase date for all Refurbished (B-Stock) and Discontinued hardware and electronic products purchased on or after June 1, 2013.

Remedy

Atlona recommends that end-purchasers contact their authorized Atlona dealer or reseller from whom they purchased their products. Atlona can also be contacted directly. Visit www.atlona.com for Atlona's contact information and hours of operation. Atlona requires that a dated sales or delivery receipt from an authorized dealer, reseller or end-purchaser is provided before Atlona extends its warranty services. Additionally, a return merchandise authorization (RMA) and/or case number, is required to be obtained from Atlona in advance of returns.

Atlona requires that products returned are properly packed, preferably in the original carton, for shipping. Cartons not bearing a return authorization or case number will be refused. Atlona, at its sole discretion, reserves the right to reject any products received without advanced authorization. Authorizations can be requested by calling 1-877-536-3976 (US toll free) or 1-408-962-0515 (US/international) or via Atlona's website at www.atlona.com.

Exclusions

This Limited Product Warranty excludes:

- Damage, deterioration or malfunction caused by any alteration, modification, improper use, neglect, improper packing or shipping (such claims must be presented to the carrier), lightning, power surges, or other acts of nature.
- Damage, deterioration or malfunction resulting from the installation or removal of this product from any installation, any unauthorized tampering with this product, any repairs attempted by anyone unauthorized by Atlona to make such repairs, or any other cause which does not relate directly to a defect in materials and/or workmanship of this product.
- Equipment enclosures, cables, power supplies, batteries, LCD displays, and any accessories used in conjunction with the product(s).
- Products purchased from unauthorized distributors, dealers, resellers, auction websites and similar unauthorized channels of distribution.

Disclaimers

This Limited Product Warranty does not imply that the electronic components contained within Atlona's products will not become obsolete nor does it imply Atlona products or their electronic components will remain compatible with any other current product, technology or any future products or technologies in which Atlona's products may be used in conjunction with. Atlona, at its sole discretion, reserves the right not to extend its warranty offering in instances arising outside its normal course of business including, but not limited to, damage inflicted to its products from acts of god.

Limitation on Liability

The maximum liability of Atlona under this limited product warranty shall not exceed the original Atlona MSRP for its products. To the maximum extent permitted by law, Atlona is not responsible for the direct, special, incidental or consequential damages resulting from any breach of warranty or condition, or under any other legal theory. Some countries, districts or states do not allow the exclusion or limitation of relief, special, incidental, consequential or indirect damages, or the limitation of liability to specified amounts, so the above limitations or exclusions may not apply to you.

Exclusive Remedy

To the maximum extent permitted by law, this limited product warranty and the remedies set forth above are exclusive and in lieu of all other warranties, remedies and conditions, whether oral or written, express or implied. To the maximum extent permitted by law, Atlona specifically disclaims all implied warranties, including, without limitation, warranties of merchantability and fitness for a particular purpose. If Atlona cannot lawfully disclaim or exclude implied warranties under applicable law, then all implied warranties covering its products including warranties of merchantability and fitness for a particular purpose, shall provide to its products under applicable law. If any product to which this limited warranty applies is a "Consumer Product" under the Magnuson-Moss Warranty Act (15 U.S.C.A. §2301, ET SEQ.) or other applicable law, the foregoing disclaimer of implied warranties shall not apply, and all implied warranties on its products, including warranties of merchantability and fitness for the particular purpose, shall apply as provided under applicable law.

Other Conditions

Atlona's Limited Product Warranty offering gives legal rights, and other rights may apply and vary from country to country or state to state. This limited warranty is void if (i) the label bearing the serial number of products have been removed or defaced, (ii) products are not purchased from an authorized Atlona dealer or reseller. A comprehensive list of Atlona's authorized distributors, dealers and resellers can be found at www.atlona.com.

Atlona, Inc Product Registration

Thank you for purchasing this Atlona product. - We hope you enjoy it and will take an extra few moments to register your new purchase.

Registration creates an ownership record if your product is lost or stolen and helps ensure you'll receive notification of performance issues and firmware updates.

At Atlona we respect and protect your privacy, assuring you that your registration information is completely secure. Atlona product registration is completely voluntary and failure to register will not diminish your limited warranty rights.

To register go to: <http://www.atlona.com/registration>