

Network-Enabled Occupancy Sensor

AT-OCS-900N

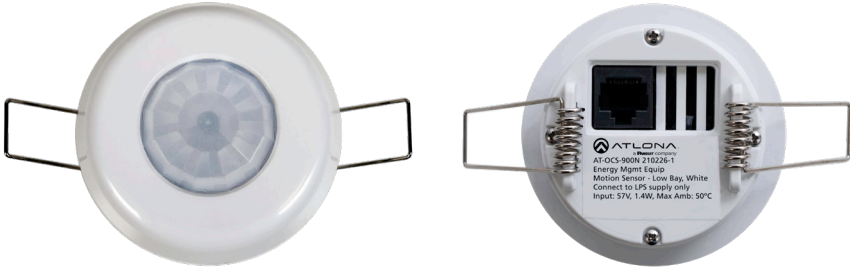

The Atlona **AT-OCS-900N** is a network-enabled multi-function sensor designed for use in a wide variety of AV automation applications. This ceiling mounted sensor uses passive infrared (PIR) technology to detect occupancy in the coverage area. The OCS-900N utilizes an IP network to communicate with select Atlona products and the Velocity™ system to automatically control AV components based on whether the space is occupied. It comes with two lenses that cover approximately 900 or 2,000 square feet depending on ceiling height. A blinder insert is included that limits the sensor's field of view, preventing detection in unwanted areas such as doorways or windows with heavy cross traffic. Installation is simplified by Power over Ethernet (PoE), that provides both communications and power over a single cable as well as spring-loaded clamps that secure the sensor to a ceiling tile.

In addition to occupancy, the OCS-900N also captures temperature and ambient light level information. Its open standard design allows sensor information to be communicated to third-party ventilation, lighting, and other systems over TCP/IP using common protocols such as UDP, TCP, WebSocket, and MQTT.

Package Contents

- 1 x AT-OCS-900N with installed Standard Ceiling lens
- 1 x 120-degree optics shader
- 1 x High Ceiling lens
- 1 x Installation guide



IMPORTANT: Visit <http://www.atlona.com/product/AT-OCS-900N> for the latest firmware updates and documentation.

Installation



IMPORTANT: This product is designed to be installed by instructed or skilled person(s) only. Also, do not touch or apply pressure to the IR sensor. Doing so may damage or break the IR sensor.

1. Determine the coverage area required. Refer to [Coverage Pattern \(page 3\)](#) for more information.
2. Connect an Ethernet cable from the **LAN** port to the Local Area Network.

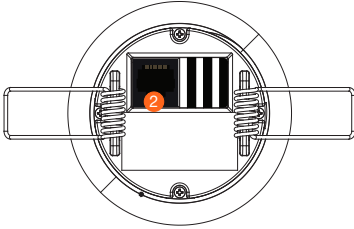

3. In a pre-drilled 2.5" hole, fold the wing clips towards the center of the AT-OCS-900N. The recommended mounting hole diameter is 2.5" and should not exceed a diameter of 2.90". Refer to [Figure 1.1](#) for dimensions of the AT-OCS-900N.
4. Insert the device into the ceiling tile and release clips. The wing clips will return to the down position, securing the unit in place.

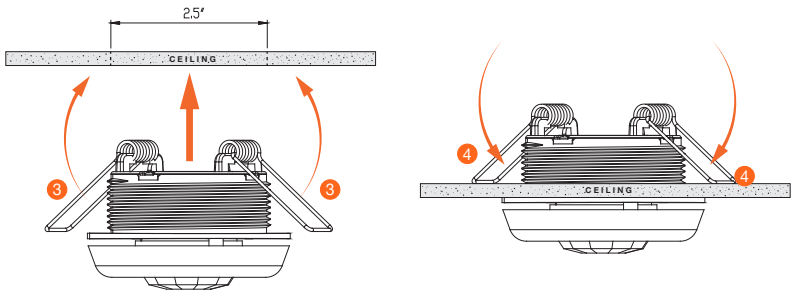
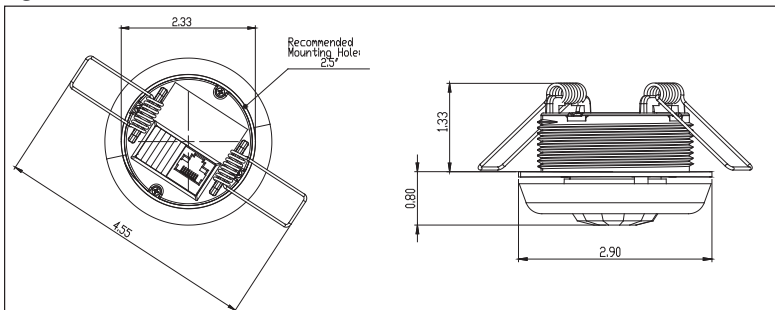

Figure 1.1



Coverage Pattern

The AT-OCS-900N includes a factory-installed Standard Ceiling lens. The Standard Ceiling lens can be replaced with the included High Ceiling lens, depending on the size of the room. Refer to the diagrams below for coverage area and the User Manual for lens removal instructions.

Standard Ceiling Coverage

Top View

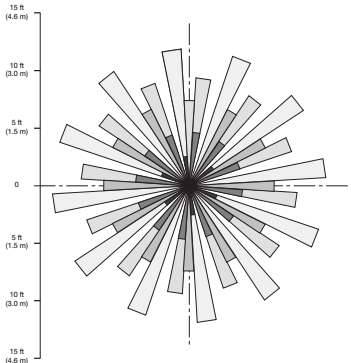

High Ceiling Coverage

Top View

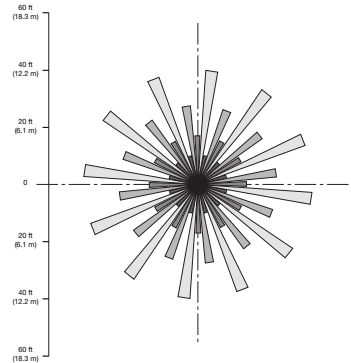

Side View

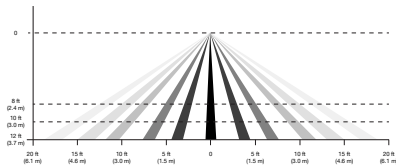

Side View

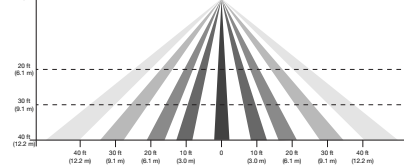

Accessing the Web Server

The AT-OCS-900N includes a built-in web server, which allows easy management and control of all features.

1. Verify that the AT-OCS-900N, and the computer used to manage the AT-OCS-900N, are connected to the same network.
2. Launch a web browser and enter the IP address of the unit.
3. The **Registration** page will be displayed.
4. Enter the username, password, and confirm the password on the registration page to register the device. Both the username and password must consist of 5 - 16 alphanumeric characters/symbols.
5. Click on **Register** button.
6. After clicking the register button, the dashboard of the built-in web server will be displayed.

Warranty

To view the product warranty, use the following link or QR code:

<https://atlona.com/warranty/>.



English Declaration of Conformity

The English version can be found under the resources tab at:

<https://atlona.com/product/at-ocs-900n/>.



Chinese Declaration of Conformity 中国RoHS合格声明

由SKU列出於:

<https://atlona.com/about-us/china-rohs/>.

