

4K/UHD Five-Input Universal Matrix Switcher with Wireless Presentation Link



Version Information

Version	Release Date	Notes
6	Jul 2022	Type correction on page 106.

Sales, Marketing, and Customer Support

Main Office

Atlona Incorporated
70 Daggett Drive
San Jose, CA 95134
United States

Office: +1.408.962.0515

Sales and Customer Service Hours
Monday - Friday: 6:00 a.m. - 4:30 p.m. (PST)

<https://atlona.com/>

International Headquarters

Atlona International AG
Tödistrasse 18
8002 Zürich
Switzerland

Office: +41.43.508.4321

Sales and Customer Service Hours
Monday - Friday: 09:00 - 17:00 (UTC +1)

Operating Notes



IMPORTANT: Visit <https://atlona.com/product/sw-510w/> for the latest firmware updates and User Manual.

Warranty



To view the product warranty, use the following link or QR code:

<https://atlona.com/warranty/>.

Safety and Certification



CAUTION: TO REDUCE THE RISK OF ELECTRIC SHOCK DO NOT OPEN ENCLOSURE OR EXPOSE TO RAIN OR MOISTURE. NO USER-SERVICEABLE PARTS INSIDE REFER SERVICING TO QUALIFIED SERVICE PERSONNEL.



The exclamation point within an equilateral triangle is intended to alert the user to the presence of important operating and maintenance instructions in the literature accompanying the product.



The information bubble is intended to alert the user to helpful or optional operational instructions in the literature accompanying the product.

1. Read these instructions.
2. Keep these instructions.
3. Heed all warnings.
4. Follow all instructions.
5. Do not use this product near water.
6. Clean only with a dry cloth.
7. Do not block any ventilation openings. Install in accordance with the manufacturer's instructions.
8. Do not install or place this product near any heat sources such as radiators, heat registers, stoves, or other apparatus (including amplifiers) that produce heat.
9. Do not defeat the safety purpose of a polarized or grounding-type plug. A polarized plug has two blades with one wider than the other. A grounding type plug has two blades and a third grounding prong. The wide blade or the third prong are provided for your safety. If the provided plug does not fit into your outlet, consult an electrician for replacement of the obsolete outlet.
10. Protect the power cord from being walked on or pinched particularly at plugs, convenience receptacles, and the point where they exit from the product.
11. Only use attachments/accessories specified by Atlona.
12. To reduce the risk of electric shock and/or damage to this product, never handle or touch this unit or power cord if your hands are wet or damp. Do not expose this product to rain or moisture.
13. Unplug this product during lightning storms or when unused for long periods of time.
14. Refer all servicing to qualified service personnel. Servicing is required when the product has been damaged in any way, such as power-supply cord or plug is damaged, liquid has been spilled or objects have fallen into the product, the product has been exposed to rain or moisture, does not operate normally, or has been dropped.



FCC Compliance

FCC Compliance and Advisory Statement: This hardware device complies with Part 15 of the FCC rules. Operation is subject to the following two conditions: 1) this device may not cause harmful interference, and 2) this device must accept any interference received including interference that may cause undesired operation. This equipment has been tested and found to comply with the limits for a Class A digital device, pursuant to Part 15 of the FCC Rules. These limits are designed to provide reasonable protection against harmful interference in a commercial installation. This equipment generates, uses, and can radiate radio frequency energy and, if not installed or used in accordance with the instructions, may cause harmful interference to radio communications. However there is no guarantee that interference will not occur in a particular installation. If this equipment does cause harmful interference to radio or television reception, which can be determined by turning the equipment off and on, the user is encouraged to try to correct the interference by one or more of the following measures: 1) reorient or relocate the receiving antenna; 2) increase the separation between the equipment and the receiver; 3) connect the equipment to an outlet on a circuit different from that to which the receiver is connected; 4) consult the dealer or an experienced radio/TV technician for help. Any changes or modifications not expressly approved by the party responsible for compliance could void the user's authority to operate the equipment. Where shielded interface cables have been provided with the product or specified additional components or accessories elsewhere defined to be used with the installation of the product, they must be used in order to ensure compliance with FCC regulations.

Copyright, Trademark, and Registration

© 2022 Atlona Inc. All rights reserved. "Atlona" and the Atlona logo are registered trademarks of Atlona Inc. Pricing, specifications and availability subject to change without notice. Actual products, product images, and online product images may vary from images shown here.

HDMI™ The terms HDMI, HDMI High-Definition Multimedia Interface, and the HDMI Logo are trademarks or registered trademarks of HDMI licensing Administrator, Inc.

Dolby, Dolby Atmos, and the double-D symbol are registered trademarks of Dolby Laboratories Licensing Corporation.

For DTS patents, see <http://patents.dts.com>. Manufactured under license from DTS, Inc. DTS, the Symbol, DTS and the Symbol together, and Digital Surround are registered trademarks and/or trademarks of DTS, Inc. in the United States and/or other countries. © DTS, Inc. All Rights Reserved.

All other trademark(s), copyright(s), and registered technologies mentioned(s) in this document are the properties of their respective owner(s).

Table of Contents

Introduction	7
Features	7
Package Contents	7
Panel Description	8
Front Panel - Revision A and B	8
Front Panel - Revision C	8
Rear Panel - All Revisions	9
Installation	10
Connectors	10
RS-232	10
Audio	10
Relay	11
Trigger I/O	11
Connection Instructions	12
Connection Diagram	14
IP Configuration	15
Getting the IP Address	15
Getting the IP Address without a Display	15
Switching the IP Mode Using the Front Panel	16
Auto IP Mode	16
Setting the IP Address using the Web Server	17
Resetting to Factory-Default Settings	18
Device Operation	19
LED Indicators	19
Logging in to the Web Server	20
Login Registration	20
Logging in after registration	21
Setting the System Date and Time	22
Automatic Adjustment	22
Setting Local Date and Time	23
Using an NTP Server	23
Selecting the Input	24
Switching Modes	25
Matrix Mode	25
Matrix Mode w/ Static Route	27
Auto-Switching	29
Enabling / Disabling Auto Switching	29
The Splash Screen	30
Customizing Text	30
Displaying Metadata	33
Displaying the Wireless Password	34
Cycling Background Images	35
Uploading Custom Images	36
HTML Splash Screens	37
Resetting the HTML Splash Screen	40
Wireless Configuration	41
Access Point Mode	41
Firewall Mode	44
Connect to WiFi Mode	45
Changing the SSID	48
802.1X Authentication	49
Ethernet Connections	49
WiFi Connections	51

Table of Contents

Casting	52
iOS Devices	52
OS X Devices	53
Microsoft Miracast	55
Google Chrome	55
Audio Management	57
Using External Audio Sources	57
Controlling Audio Output Volume	57
AirPlay Bluetooth Discovery	58
AirPlay / Miracast P2P PIN Codes	59
Changing the PIN Timeout	61
Moderator Mode	62
Display Control Methods	65
Active Video Presence	65
Active Video Presence with Occupancy Sensor	67
Occupancy Sensor	68
Day and Time	70
Access Point	71
Changing the Password	72
Configuration and Management Interfaces	73
Web Server	73
Login Register page	73
Login page	74
Info page	75
General page	76
System page	77
Status page	80
Splash Screen page	81
Routing page	84
Display page	85
EDID page	91
Administration > Telnet page	92
Administration > Moderator page	93
Administration > Networking page	94
Administration > Debug page	100
Administration > User Accounts page	101
Administration > Advanced page	102
Administration > Pre-Release page	107
Administration > Audio page	108
Administration > Event Viewer page	109
Appendix	110
Updating the Firmware	110
Mounting Instructions	115
Single-unit Rack Installation	115
Dual-unit Rack Installation	116
Flat Surface	117
Specifications	118

Introduction

The Atlona **AT-UHD-SW-510W** is a 5x2, multi-format matrix switcher with wireless presentation capability. It provides universal BYOD (bring your own device) compatibility with HDMI, DisplayPort, and USB-C inputs, plus wireless connectivity for mobile devices. The SW-510W is HDCP 2.2 compliant, and features matrixed or mirrored HDMI and HDBaseT outputs. The HDBaseT output is ideal for use with the Atlona AT-UHD-EX-100CE-RX-PSE HDBaseT receiver, or the AT-HDVS-SC-RX scaling HDBaseT receiver. It also includes automatic input switching and automatic display control capability, both applicable to wired and wireless source connections. This unique multi-format matrix switcher and wireless gateway provides a universal connectivity solution for presentation devices in a wide range of professional AV applications.

The USB-C w/ charging port on the SW-510W is ideal for newer Mac, Chromebook, and Windows PCs. All inputs and the local HDMI output are compatible with video signals up to 4K/UHD @ 60 Hz with 4:4:4 chroma sampling, as well as data rates up to 18 Gbps. For integration convenience and flexibility, simultaneous 18 Gbps HDMI and 10 Gbps HDBaseT outputs make the SW-510W ideal for various presentation scenarios such as primary and confidence displays in a corporate auditorium or lecture hall. The HDBaseT output extends video, audio, control, and Ethernet up to 100 meters. (For AV signals exceeding 10 Gbps, 4K/UHD video will be subsampled to 4:2:0, or HDR metadata removed for HDBaseT transmission.)

Features

- Two HDMI®, one DisplayPort, and one USB-C input, plus an input for wireless AV.
- Matrixed or mirrored HDBaseT™ and HDMI outputs.
- Wireless AV gateway for iOS®, Android™, Mac®, Chromebook™, and Windows® devices.
- 4K/UHD capability @ 60 Hz with 4:2:0 chroma subsampling, plus support for 4K/60 4:4:4 and HDR formats on local ports (HDMI, USB-C, and DisplayPort).
- HDCP 2.2 compliant.
- Automatic input selection and automatic display control.
- USB-C port supports device charging for laptops, tablets, and smartphones.

Package Contents

1 x AT-UHD-SW-510W
1 x Captive screw connector, 5-pin
1 x Captive screw connector, 4-pin
2 x Captive screw connector, 3-pin
2 x Wi-Fi antenna modules
1 x USB-C cable, 2 meters
1 x 24V DC power supply
2 x Mounting plates
4 x Mounting screws
1 x Installation Guide

Panel Description



NOTE: As of April 2019, Revision C is being shipped. Hardware revisions A and B were shipped prior to April of 2019. However, all hardware revisions support the latest version of firmware.

Front Panel - Revision A and B

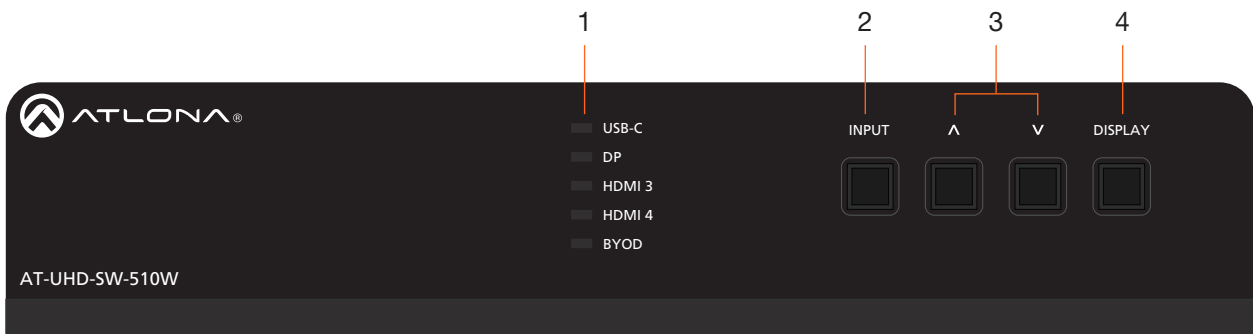

1 Input Indicators

Displays the currently selected input.

2 INPUT

Press this button to cycle through each input.

3 Cursor Buttons

Adjust the volume on the display.

4 DISPLAY

Press this button to toggle the power state of the desired display.

Front Panel - Revision C

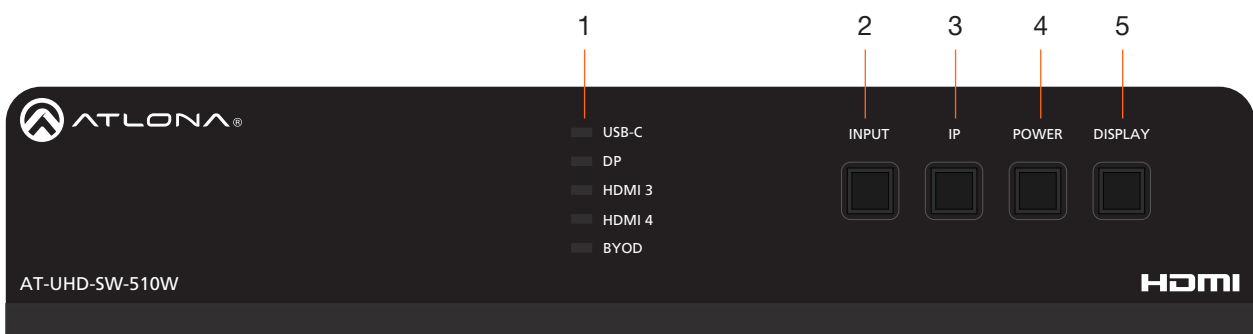

1 Input Indicators

Displays the currently selected input.

2 INPUT

Press this button to cycle through each input.

3 IP

Press this button to display the IP address of the AT-UHD-SW-510W on the connected display.

4 POWER

Press and hold this button for five seconds to power-off the AT-UHD-SW-510W. To power-on the unit, disconnect and reconnect the power cord on the rear panel.

5 DISPLAY

Press this button to toggle the power state of the desired display.

Rear Panel - All Revisions

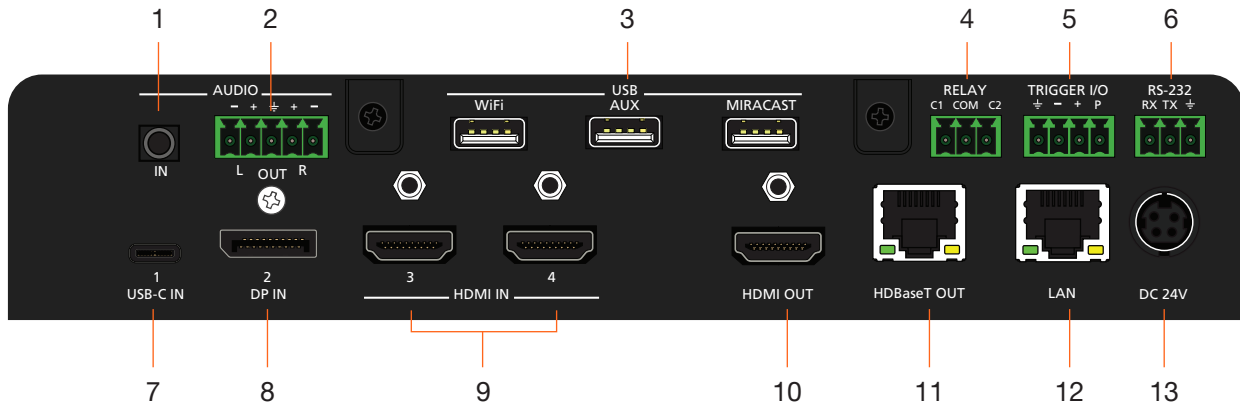

- 1 AUDIO IN**
Connect a 3.5 mm mini-stereo cable from an analog audio source to this connector.
- 2 AUDIO OUT**
Use the included captive screw connector to connect a balanced audio device.
- 3 USB**
Connect the included Wi-Fi modules to the **WiFi** and **MIRACAST** ports. Refer to [Connection Instructions \(page 12\)](#) for more information. Note that on Revision A hardware, the **MIRACAST** port is labeled **WiFi**.
- 4 RELAY**
Connect one of the included 3-pin captive screw connectors to this port to control screens, drapes, lights, or other devices.
- 5 TRIGGER I/O**
Connect voltage-controlled device to this port. A 4-pin captive screw connector is required.
- 6 RS-232**
Use the included 3-pin captive screw connector to connect an RS-232 controller or automation system.
- 7 USB-C**
Connect a USB-C cable from this port to a USB-C source.
- 8 DP IN**
Connect a DisplayPort device to this port.
- 9 HDMI IN**
Connect an HDMI cable from each of these ports to a UHD/HD source.
- 10 HDMI OUT**
Connect an HDMI cable from this port to an HD/UHD display.
- 11 HDBaseT OUT**
Connect to a locally powered HDBaseT receiver such as the AT-UHD-EX-100CE-RX-PSE.
- 12 LAN**
Connect an Ethernet cable from this port to the network.
- 13 DC 24V**
Connect the included 24 V DC power supply to this power receptacle.

Installation

Connectors

RS-232

The AT-UHD-SW-510W provides an RS-232 port which can be used to control a display connected to the HDMI output. Atlona recommends controlling the AT-UHD-SW-510W using IP and reserving the RS-232 port for local display control.

1. Use wire strippers to remove a portion of the cable jacket.
2. Remove at least 3/16" (5 mm) of insulation from each of the wires.
3. Insert the wires into correct terminal using the included 3-pin captive screw connector.
4. Attach the 3-pin connector block to the **RS-232** port on the AT-UHD-SW-510W.

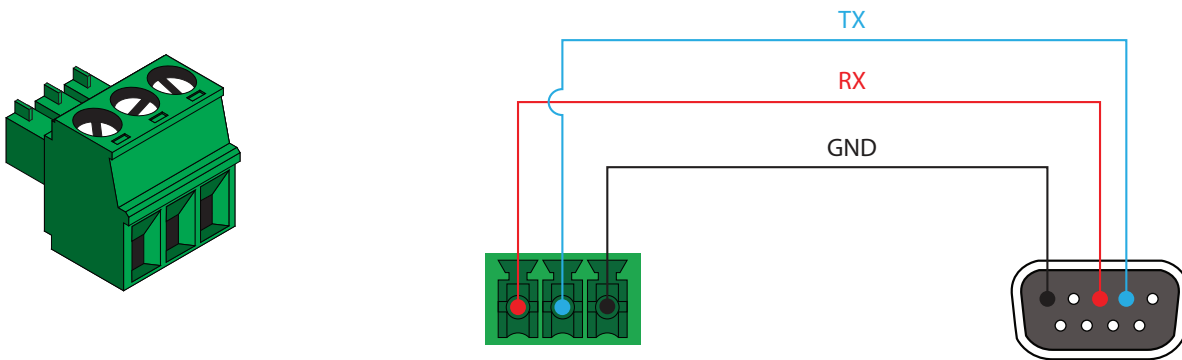

Audio

The AT-UHD-SW-510W provides the ability to output two-channel balanced analog audio on the **AUDIO OUT** port, using the included 5-pin captive screw connector.

Use wire strippers to remove enough insulation to allow each wire to be securely fastened to each terminal of the captive screw connector block and connect the wires as shown.

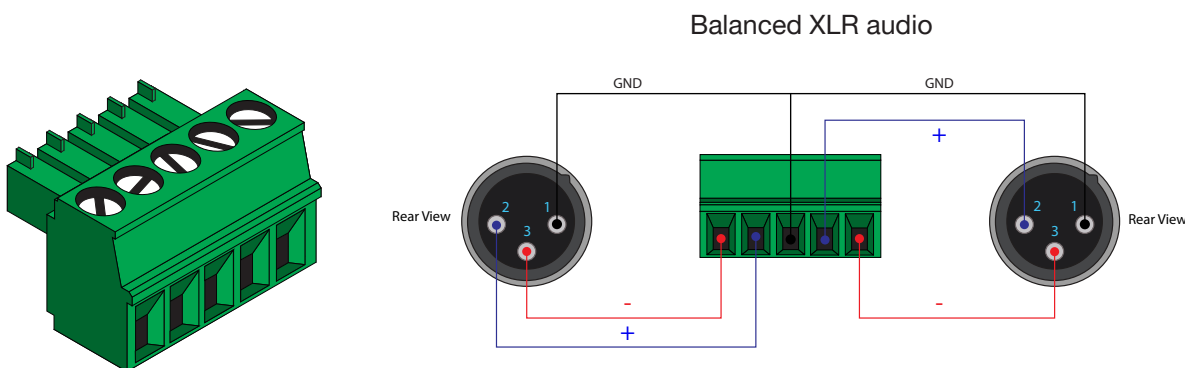

NOTE: If unbalanced audio is needed, then it is recommended to use a stereo balanced to unbalanced converter.

Relay

The AT-UHD-SW-510W provides a **RELAY** port, allowing the control of screens, curtains, and other devices. Use a 48 V DC relay with no more than 1 A current draw.

When the AT-UHD-SW-510W is powered-on or rebooted, **C1** and **C2** are set to the Normally Open (NO) state.

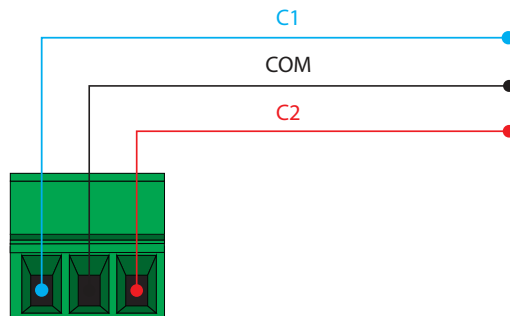
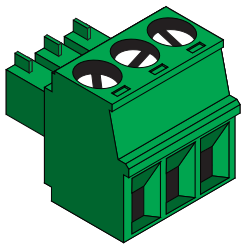

Trigger I/O

The **TRIGGER I/O** port allows voltage-controlled devices, such as an occupancy sensor, to be connected to the AT-UHD-SW-510W. Use the included 4-pin captive screw connector to connect the device. Voltage range is 3 to 30 V DC.

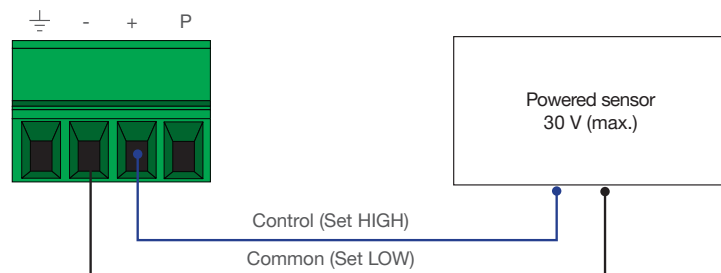
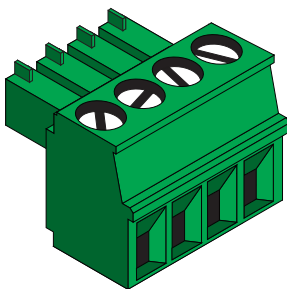

Powered sensor

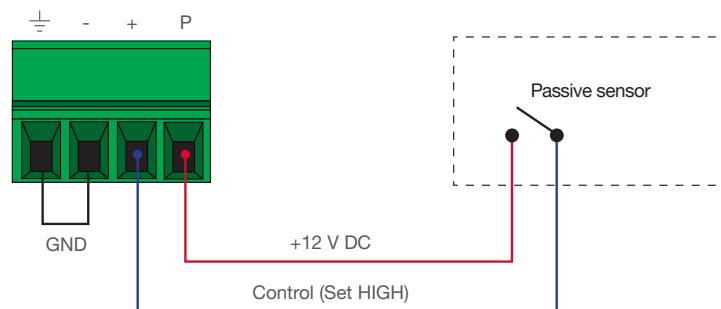

Passive sensor

Connection Instructions

1. Connect a USB-C cable from a source to the **USB-C (1)** port.
2. Connect a DisplayPort cable from a source to the **DP IN (2)** port.
3. Connect up to two UHD/HD sources, using HDMI cables, to the **HDMI IN (3)** and **HDMI IN (4)** ports.
4. Connect an HDMI cable from the **HDMI OUT** port to a UHD/HD display.
5. Connect the included USB wireless antennas to the **WiFi** and **MIRACAST** ports. The **WiFi** port supports Google Cast™ and Apple AirPlay®. The **MIRACAST** port only supports Miracast™. The **AUX** port is reserved for obtaining the IP address of the unit and for unit recovery. Refer to [IP Configuration \(page 15\)](#) for more information. Note that on hardware revision A, the **MIRACAST** port is labeled as **WiFi**.

 **IMPORTANT:** Only use Atлона Wi-Fi USB modules. Other Wi-Fi modules may not be supported by this product.

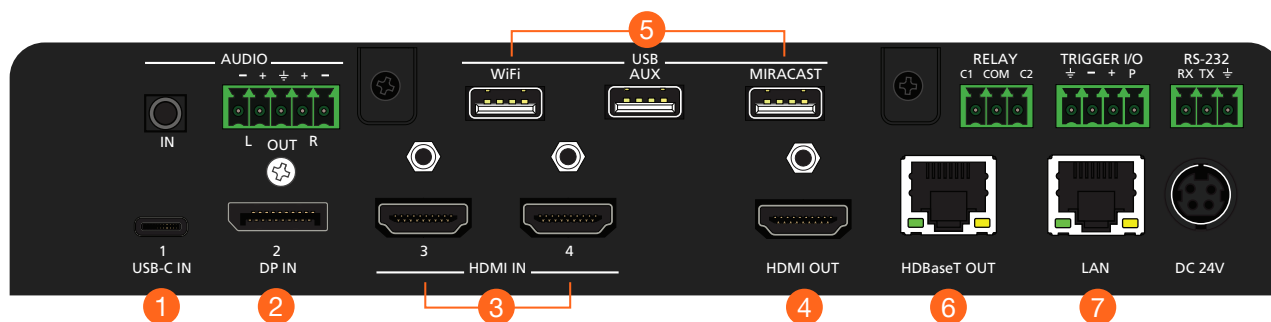

6. Connect a category cable (CAT-5e or better), up to 330 feet (100 meters), from the **HDBaseT OUT** port to a compatible receiver, such as the AT-OME-EX-RX.
7. Connect an Ethernet cable from the **LAN** port to the Local Area Network (LAN). Atлона recommends this step and provides access to the built-in web server, which can be used to control and manage the AT-UHD-SW-510W.

Core	Shielding	CAT5e	CAT6	CAT6a	CAT7
Solid	UTP (unshielded)	■	■■■	■■■■	N/A
	STP (shielded)	■■	■■■■	■■■■■	■■■■■

Cable	Max. Distance @ 4K	Max. Distance @ 1080p
CAT5e	295 feet (90 meters)	330 feet (100 meters)
CAT6a / CAT6a / CAT7	330 feet (100 meters)	330 feet (100 meters)

 **IMPORTANT:** If connecting the AT-UHD-SW-510W to the Local Area Network (LAN), make sure that the AT-UHD-EX-100CE-RX-PSE is not connected to the LAN, as this will create a network loop.

8. OPTIONAL: Connect a 3.5 mm analog audio cable from an analog source to the **AUDIO IN** port. This audio port is used to embed analog audio on any of the input sources.
9. OPTIONAL: Connect the included green 5-pin captive screw connector to the **AUDIO OUT** connector. Refer to [Audio \(page 10\)](#) for wiring information.
10. OPTIONAL: Connect the relay leads from the control motors of the projection screen, blinds, or curtains, to the relay outputs to the **RELAY** port, using the included 3-pin captive screw connector. Use a 48 V DC relay with no more than 1 A current draw. Refer to [Relay \(page 11\)](#) for wiring information.
11. OPTIONAL: Connect a trigger device, such as an occupancy sensor switch, to the **TRIGGER I/O** port. A 4-pin captive screw connector is required. Voltages from 3 to 30 V are supported. Refer to [Trigger I/O \(page 11\)](#) for wiring information.
12. OPTIONAL: Use the included captive screw connector to connect a serial cable from the **RS-232** port on the AT-UHD-SW-510W, to the RS-232 port on the display. Refer to [RS-232 \(page 10\)](#) for wiring information.
13. Connect the included power supply to the **DC 24V** connector and connect the power cord to an available electrical outlet.
14. Follow the on-screen instructions to complete the set-up procedure.



NOTE: The AT-UHD-SW-510W may take up to five minutes to complete the initial boot process.

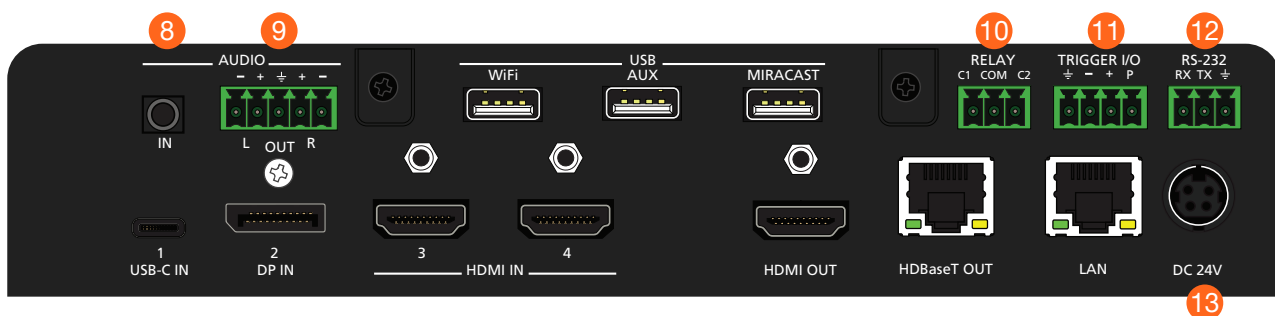

Connection Diagram

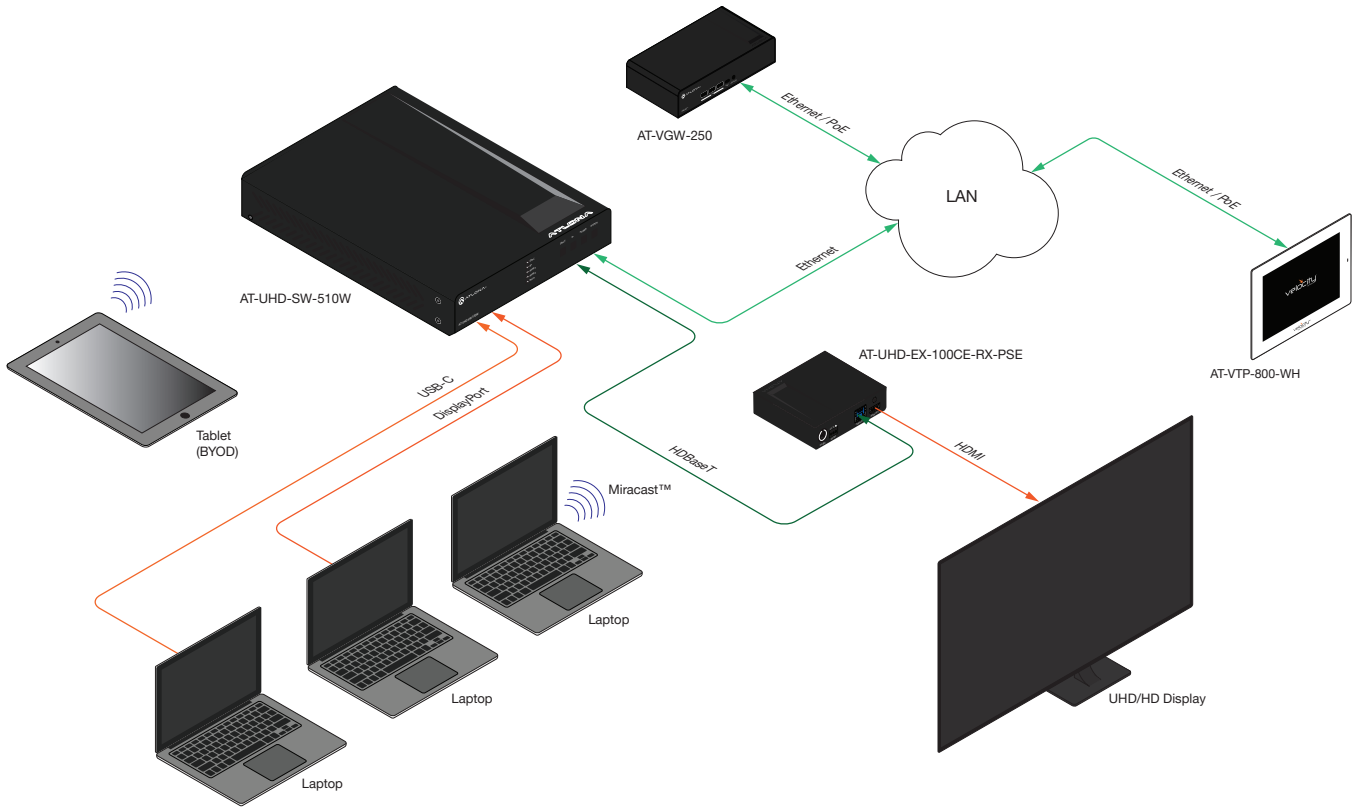

IP Configuration

The AT-UHD-SW-510W is shipped with DHCP enabled. Once connected to a network, the DHCP server (if available), will automatically assign an IP address to the unit. Pressing the SHOW IP button will display the current IP address of the AT-UHD-SW-510W. Alternatively, an IP scanner, along with the MAC address on the bottom of the unit, can also be used to identify the unit on the network.

Getting the IP Address

1. Make sure the AT-UHD-SW-510W is powered.
2. Connect a display to the HDMI output (**OUTPUT 1**). Make sure the display is powered.
3. Press and release the **IP** button on the front panel. The IP address of the AT-UHD-SW-510W will be displayed on the screen.

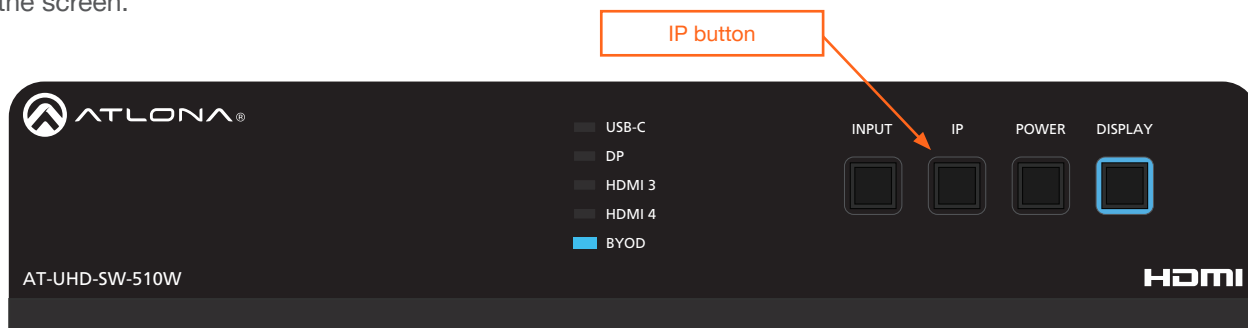

Getting the IP Address without a Display

If a display device is unavailable, use the following procedure to obtain the IP address of the AT-UHD-SW-510W.

1. Make sure the AT-UHD-SW-510W is powered and ready for operation.
2. Insert a USB drive into the **AUX** port and wait approximately 10 seconds, then remove the USB drive from the **AUX** port insert the drive into an available USB port on a computer.
3. Two files will be present on the USB drive. One file is formatted for Windows and the other is formatted for Linux.

Windows: AtlonaReport-Win-GWB-20170821200241.txt
 Linux: AtlonaReport-Unix-GWB-20170821200241.txt

4. Double-click the desired file to open it. The IP address of the AT-UHD-SW-510W is listed under Ethernet #1. An example is shown below.

Ethernet #1
 IP : 192.168.41.68
 MAC : B8:98:B0:05:7E:73

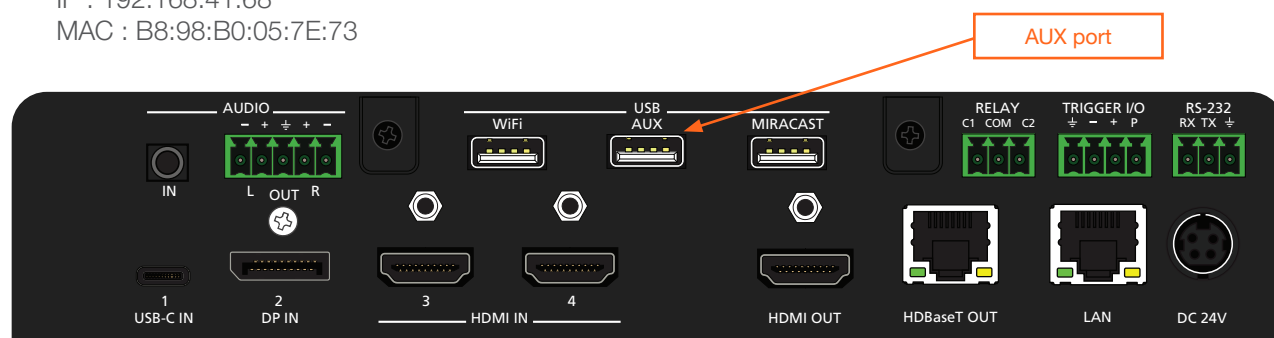

Switching the IP Mode Using the Front Panel

1. Make sure the AT-UHD-SW-510W is powered and ready for operation.
2. Press and hold the **INPUT** button for at least 15 seconds.

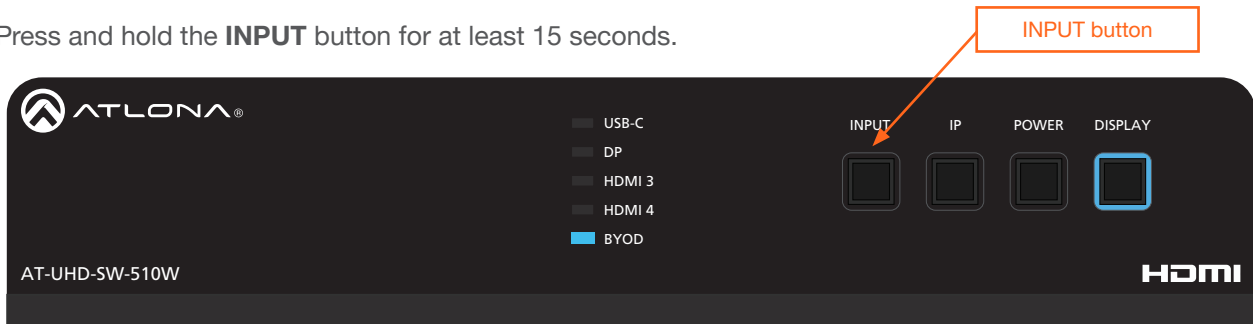

3. Release the **INPUT** button once all the front-panel LED indicators begin to flash. The unit will reboot. The number of flashes will indicate the currently selected IP mode:

Input LED Indicators flash	Description
Two	DHCP mode
Four	Factory Static IP mode (IP address set to 192.168.1.254)

Auto IP Mode

If the AT-UHD-SW-510W is unable to detect a DHCP server within 15 seconds, then the unit will use a self-assigned IP address within the IPv4 address block 169.254.0.0/16. If this occurs, connect an Ethernet cable directly from the **LAN** port of the AT-UHD-SW-510W to the LAN port of a computer, then do the following:

1. Click **Start > Settings > Control Panel > Network and Sharing Center**.
2. Click **Change adapter settings**.
3. Right-click on the adapter that is used to establish a wired connection to the network, and select **Properties** from the context menu.
4. Under the **Ethernet Properties** dialog box, select **Internet Protocol Version 4** and then click the **Properties** button. Click the **Use the following IP address** radio button.



IMPORTANT: Before continuing, write down the current IP settings in order to restore them, later. If **Obtain an IP address automatically** and **Obtain DNS server automatically** are selected, then this step is not required.

5. Enter the desired static IP address or the IP address provided by the network administrator. If the computer does not require Internet access or if a statically-assigned IP address is being used, then an address within the IPv4 address block 169.254.0.0/16 can be entered.
6. Set the subnet mask to 255.255.0.0.
7. Click the **OK** button then close all **Control Panel** windows.

Setting the IP Address using the Web Server

The IP mode of the AT-UHD-SW-510W can also be set using the built-in web server. In order to access the web server, the IP address of the AT-UHD-SW-510W must be known. Refer to [Logging in to the Web Server \(page 20\)](#) for more information.

1. Open the desired web browser and enter the IP address of the AT-UHD-SW-510W.
2. Login using the required credentials.
3. Click **Administration > Networking**.
4. Under the **Ethernet** window group, click the **Mode** drop-down list to select **DHCP**, **Static**, or **Factory Static**. If set to **Static**, the **IP**, **Network Mask**, **Gateway** fields can be modified.

If set to **Factory Static**, then the IP settings will be set to the following values:

IP Address	192.168.1.254
Network Mask	255.255.0.0
Gateway	192.168.1.1

Both **DNS Server** fields can be modified when set to either **Static** or **Factory Static** mode.

5. Under the Save window group, click the **Save** button, next to **Save Changes**, to commit changes.



NOTE: When saving network settings, the AT-UHD-SW-510W may prompt for a reboot.

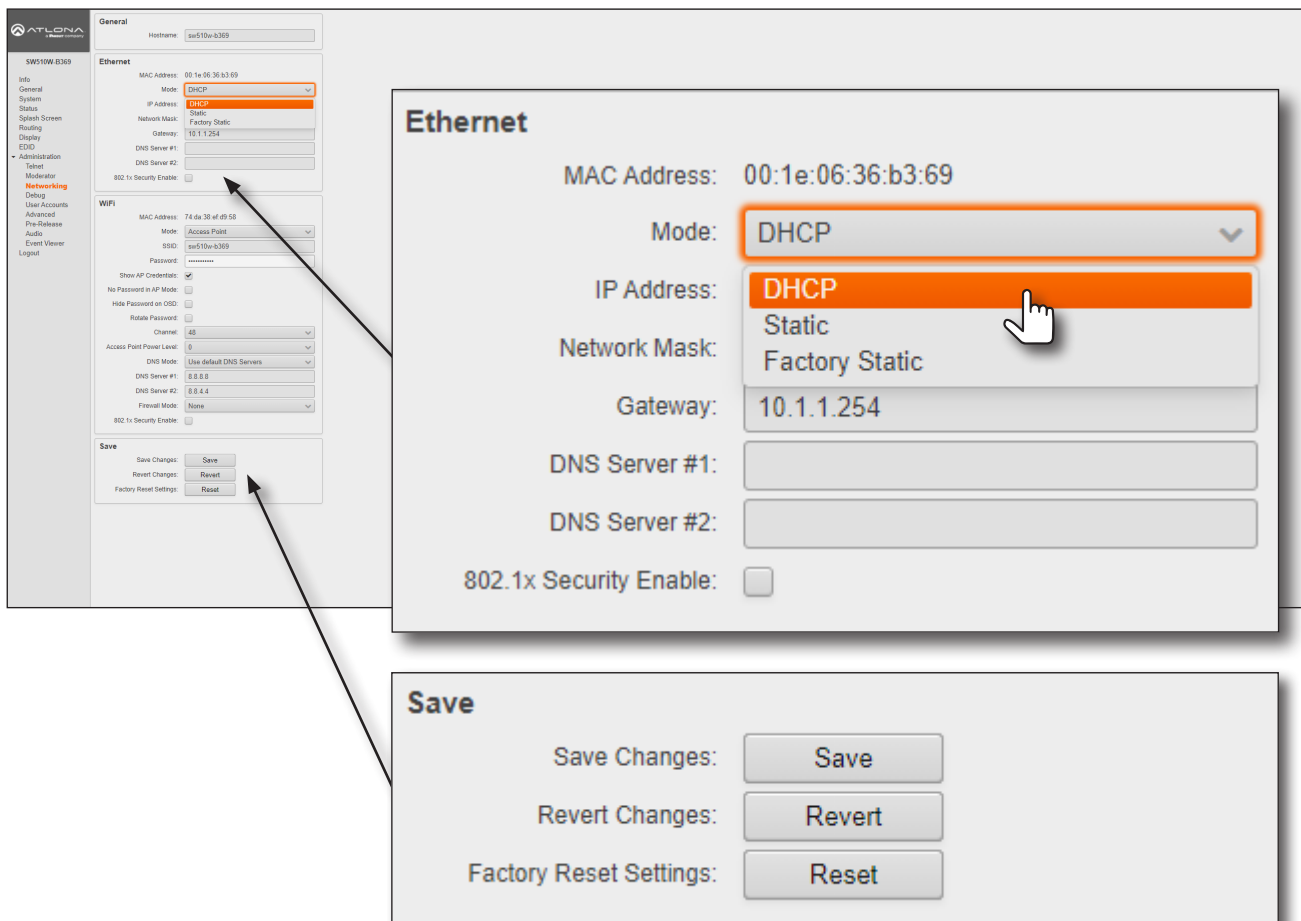

The screenshot shows the ATLONA web interface. On the left is a navigation menu with 'Administration > Networking' selected. The main content area is divided into two sections:

- Ethernet**: This section shows the MAC Address as 00:1e:06:36:b3:69. The Mode is set to DHCP. Below this, there are fields for IP Address, Network Mask, and Gateway, all currently empty. There are also fields for DNS Server #1 and #2, and a checkbox for 802.1x Security Enable.
- Save**: This section contains three buttons: 'Save Changes: Save', 'Revert Changes: Revert', and 'Factory Reset Settings: Reset'.

Arrows from the text instructions point to the 'DHCP' option in the Mode dropdown and the 'Save' button in the Save section.

Resetting to Factory-Default Settings



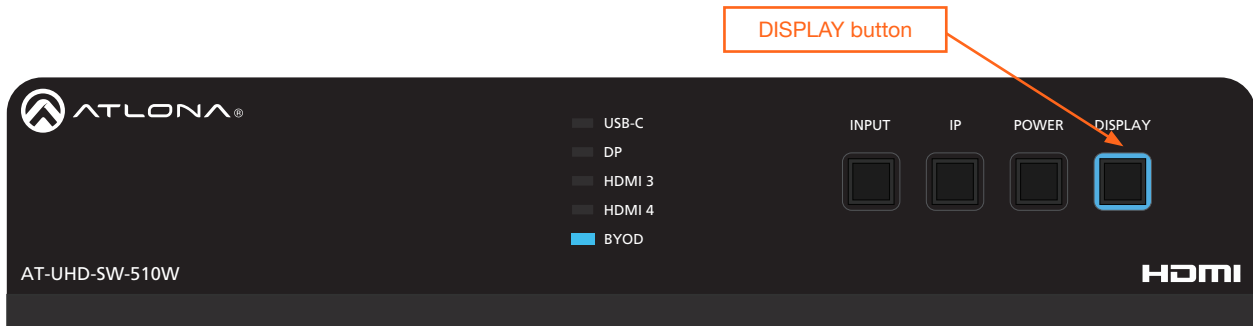



If necessary, the AT-UHD-SW-510W can be reset to factory-defaults from the front panel. Press and hold the **DISPLAY** button for 15 seconds to reset the AT-UHD-SW-510W to factory-default settings. Note that the AT-UHD-SW-510W will be placed in DHCP mode, as part of the reset procedure. The AT-UHD-SW-510W can also be reset through the web GUI. Refer to [System page \(page 77\)](#) for more information.



Device Operation

LED Indicators

The LED indicators on both the front and rear of the unit provide basic information on the current status of the AT-UHD-SW-510W. The **POWER** button has a backlit LED indicator.

LED	Description	
POWER	Solid blue 	<ul style="list-style-type: none"> Unit is powered and is in normal operating mode.
	Solid red 	<ul style="list-style-type: none"> Unit is powered and is in standby mode. Unit is booting.
	Off 	<ul style="list-style-type: none"> Unit is not powered.
USB-C DP HDMI 3 HDMI 4 BYOD	Solid blue 	<ul style="list-style-type: none"> The input is the currently selected (active) input.
	Off 	<ul style="list-style-type: none"> The input is not active.
IP MODE	Flash blue (4x) 	<ul style="list-style-type: none"> Flashes twice to indicate that the unit is being set to static IP mode and will be assigned the IP address of 192.168.1.254.
	Flash blue (2x) 	<ul style="list-style-type: none"> Flashes four times to indicate that the unit is being set to DHCP mode. Refer to IP Configuration (page 15) for more information.
	Off	<ul style="list-style-type: none"> Normal operating mode.

Logging in to the Web Server

Most of the AT-UHD-SW-510W operation is handled through the built-in web server. In order to access the web server, the IP address of the unit must be known. Refer to [IP Configuration \(page 15\)](#) for more information.

Login Registration

1. Launch the desired web browser and enter the IP address of the AT-UHD-SW-510W in the address bar.
2. The AT-UHD-SW-510W **Login Registration** page will be displayed.

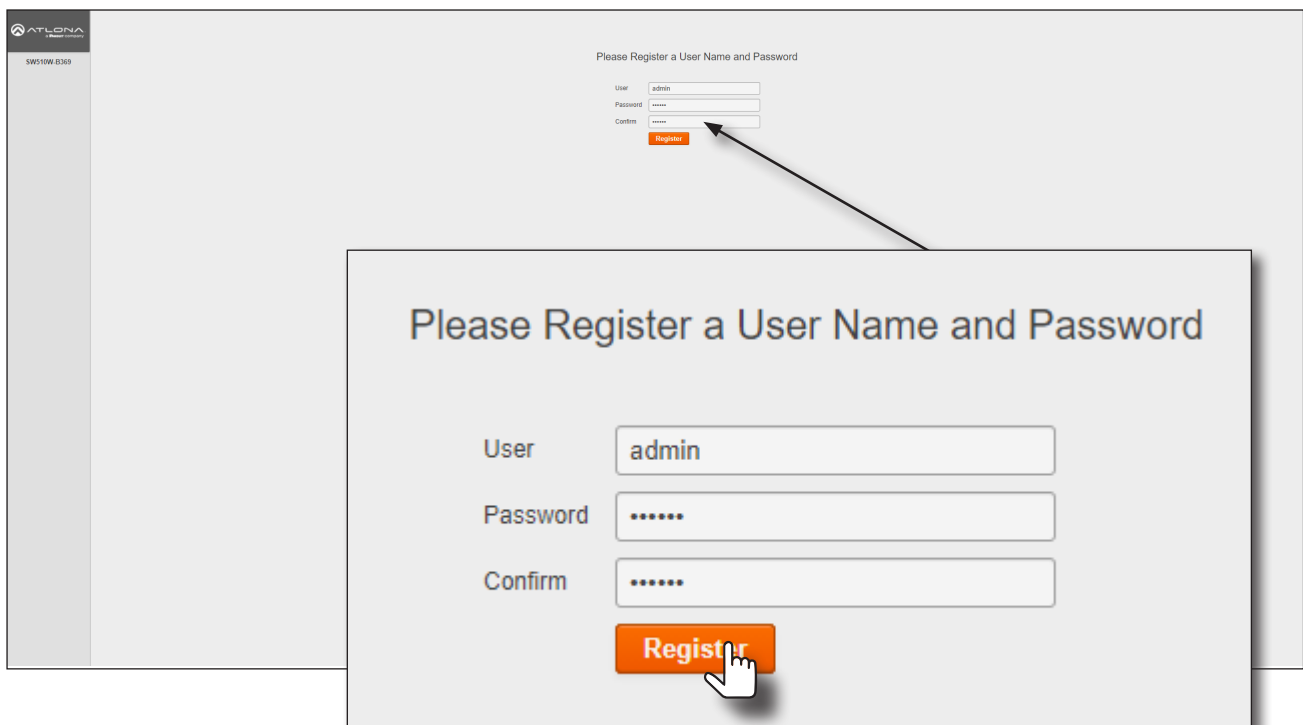

3. Enter the desired username in the **User** field. In the example above, the username `admin` is used.
4. Enter the desired password in the **Password** field.



IMPORTANT: The password must contain a minimum of 8 characters, including: 1 uppercase character, 1 lowercase character, and 1 number. Note that the **Password** and **Confirm** fields will be masked when enter the password.

5. Verify the password by entering it in the **Confirm** field.
6. Click the **Register** button.
7. The **Info** screen will be displayed. Refer to [Info page \(page 75\)](#) for more information.
8. The login registration process is complete.

Logging in after registration

1. Launch the desired web browser and enter the IP address of the AT-UHD-SW-510W in the address bar.
2. Enter the correct username and password in the respective fields.
3. Click the **Login** button.



NOTE: If using a secure connection, click the **Secure Login** button.

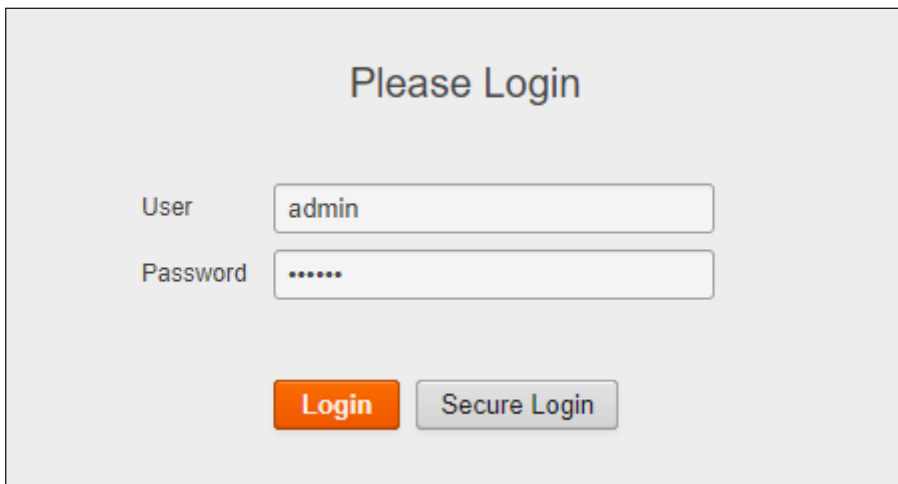

Please Login

User

Password

4. The **Info** page will be displayed and the login process is complete. Refer to [Info page \(page 75\)](#) for more information.

Setting the System Date and Time

The AT-UHD-SW-510W uses the internal clock to store the current date and time. When setting the time and date, Universal Coordinated Time (UTC) must be used.



IMPORTANT: In order for proper unit operation, it is critical that the AT-UHD-SW-510W be set to the correct UTC time setting.

Automatic Adjustment

1. Login to the web server. Refer to [Logging in to the Web Server \(page 20\)](#) for more information.
2. Click **System** in the side menu bar.
3. Under the **Time** window group, click the [here](#) link to launch a web browser and obtain the current UTC. Both the current local time and date will be set.



NOTE: Date and time can also be manually adjusted by clicking the **Set** button. However, this is not recommended.

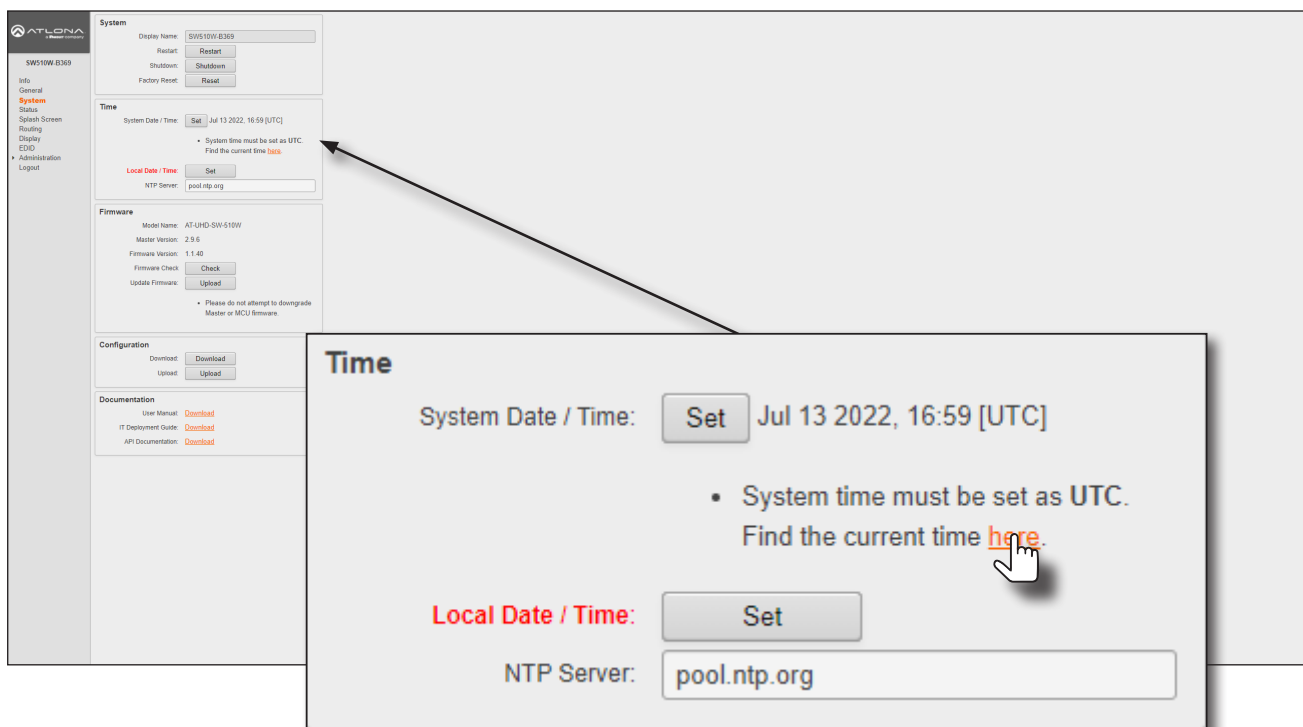

The screenshot shows the ATLONA web interface. On the left is a navigation menu with 'System' selected. The main content area is divided into sections: System, Time, Firmware, Configuration, and Documentation. The 'Time' section is highlighted with a callout box. The callout box contains the following text:

Time

System Date / Time: Jul 13 2022, 16:59 [UTC]

- System time must be set as UTC. Find the current time [here](#).

Local Date / Time:

NTP Server:

Setting Local Date and Time



IMPORTANT: If the Local Date / Time field appears highlighted in **red** (shown above), then this task must be performed to ensure proper functionality of the AT-UHD-SW-510W.

1. Login to the web server. Refer to [Logging in to the Web Server \(page 20\)](#) for more information.
2. Click **System** in the side menu bar.
3. Under the **Time** window group, next to **Local Date / Time**, click the **Set** button. Both the current local time and date will be set.

Using an NTP Server

If NTP is functioning correctly, then the date and time will be set automatically. However, the local time will need to be set.

1. Login to the web server. Refer to [Logging in to the Web Server \(page 20\)](#) for more information.
2. Click **System** in the side menu bar.
3. Under the **Time** window group, enter the desired server in the NTP Server field. The default NTP server is `pool.ntp.org`.
4. Click the **Set** button, next to **Local Date / Time**.

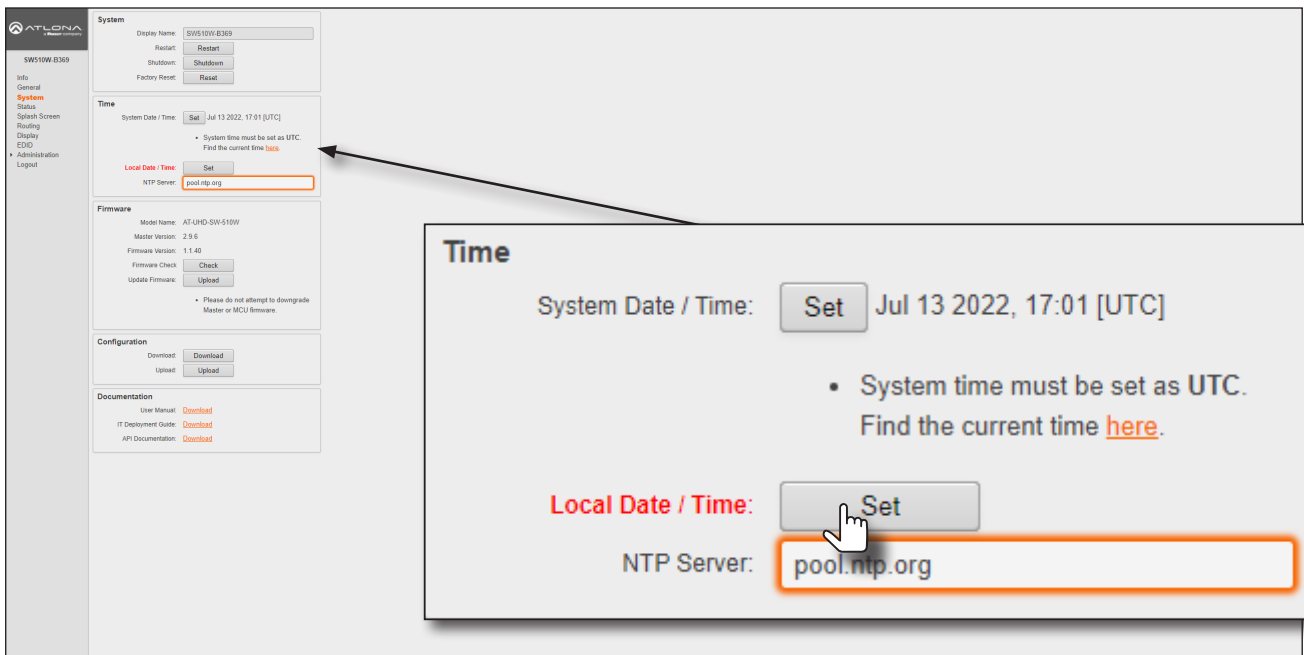

The screenshot shows the ATLONA web interface for the AT-UHD-SW-510W device. The 'System' configuration page is displayed, with the 'Time' section highlighted. The 'Local Date / Time' field is highlighted in red, and a 'Set' button is visible next to it. A callout box provides a detailed view of the 'Time' settings, showing the 'System Date / Time' as 'Jul 13 2022, 17:01 [UTC]' and a warning that 'System time must be set as UTC. Find the current time [here](#).' The 'Local Date / Time' field is highlighted in red, and a 'Set' button is visible next to it. A mouse cursor is shown clicking the 'Set' button. The 'NTP Server' field is set to 'pool.ntp.org'.

Selecting the Input

1. Login to the web server. Refer to [Logging in to the Web Server \(page 20\)](#) for more information.
2. Click **Routing** in the side menu bar.
3. Under the **Input Selection** window group, click the desired input.

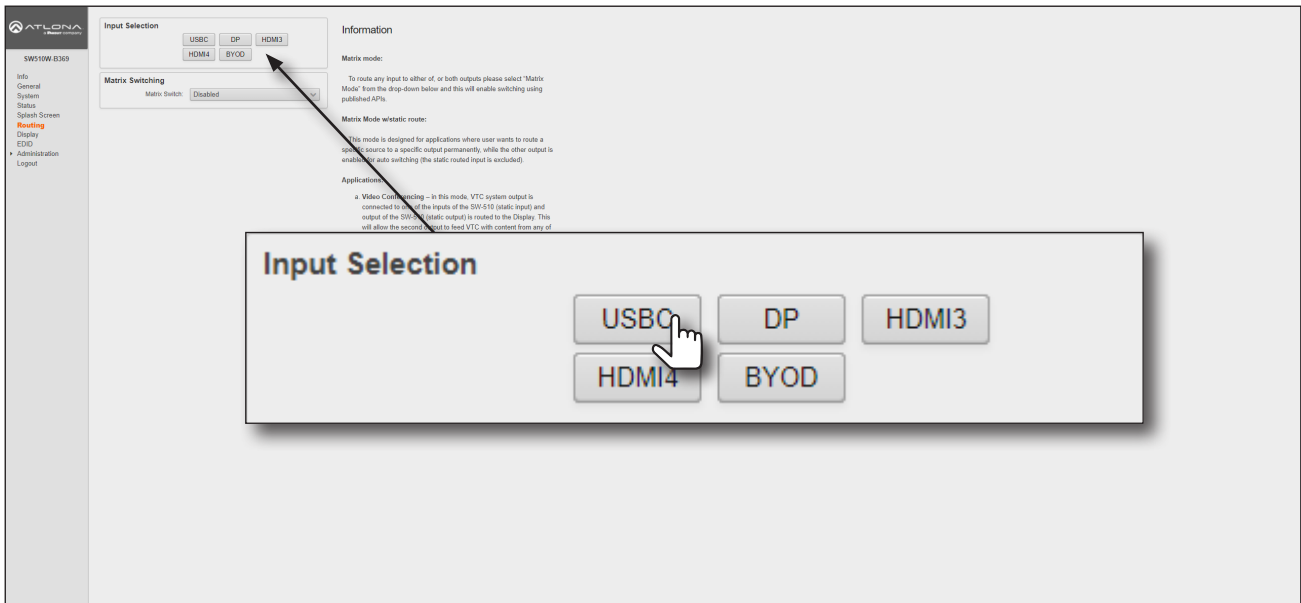

The diagram below, shows each input on the AT-UHD-SW-510W, and its associated **Input Selection** button within the web server.

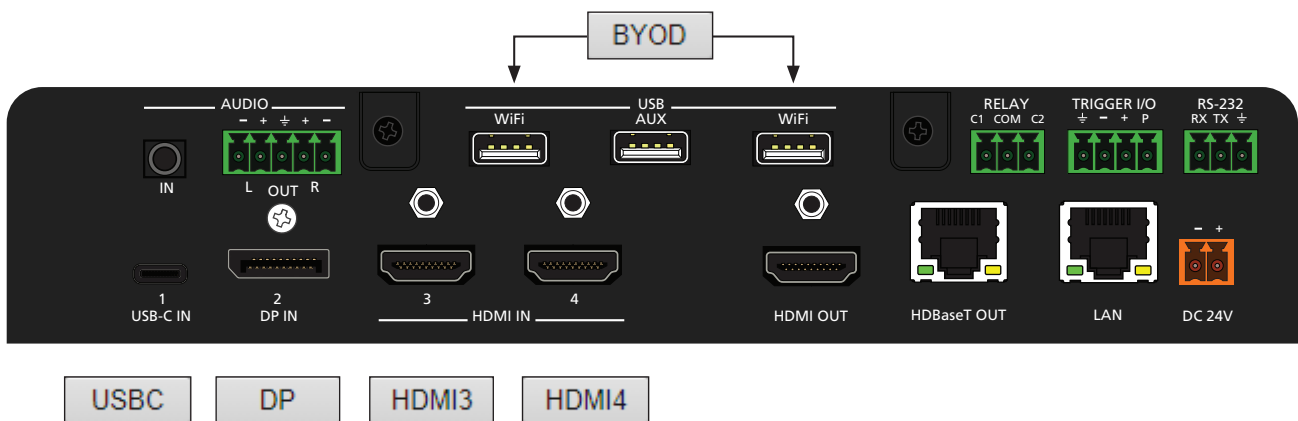

Switching Modes

The AT-UHD-SW-510W features two switching modes: **Matrix Mode** and **Matrix Mode with static route**. Each of these modes will be covered in the following section and are configured using the built-in web server.

Matrix Mode

This mode allows the AT-UHD-SW-510W to independently switch between any input to any output. Auto switching and display control is disabled in Matrix Mode.

1. Login to the web server. Refer to [Logging in to the Web Server \(page 20\)](#) for more information.
2. Click **Routing** in the side menu bar.
3. Click the **Switching Mode** drop-down list and select **Matrix Mode**.



IMPORTANT: When the AT-UHD-SW-510W is set to Matrix Mode, both auto-switching and display control will be disabled.

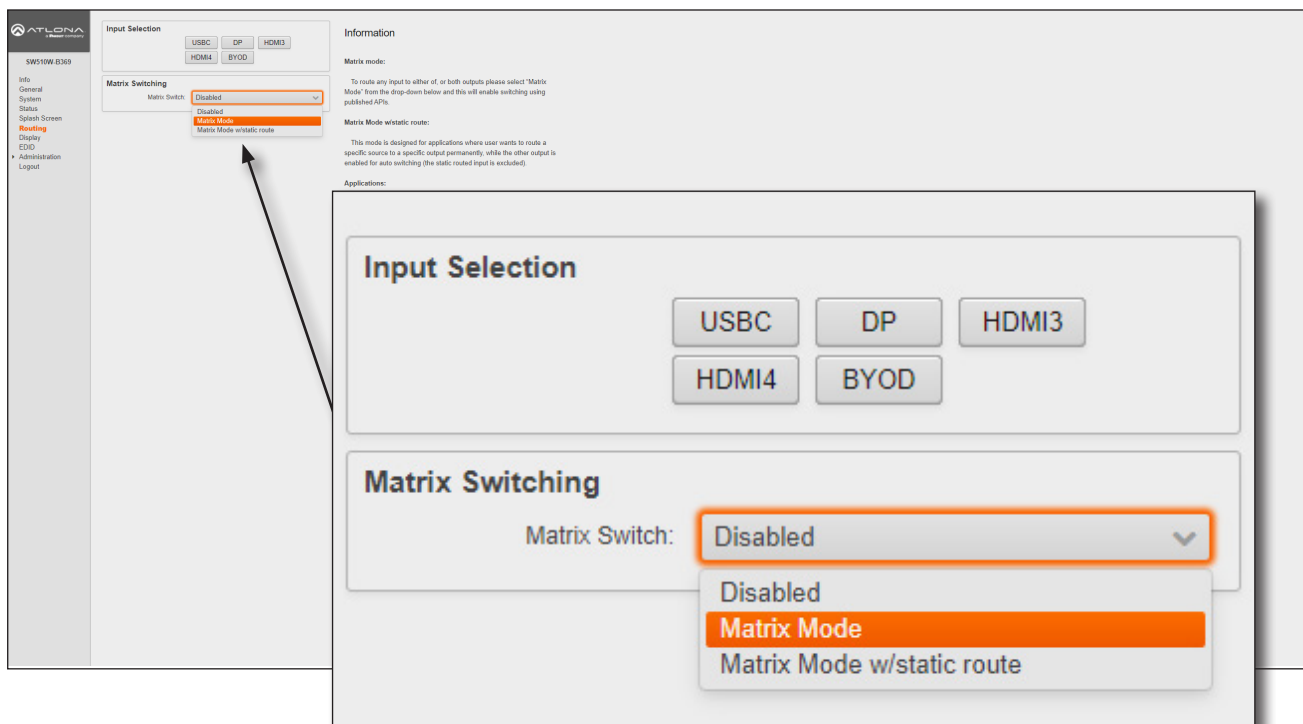

4. The **Matrix Switching** window group now contains the following options:

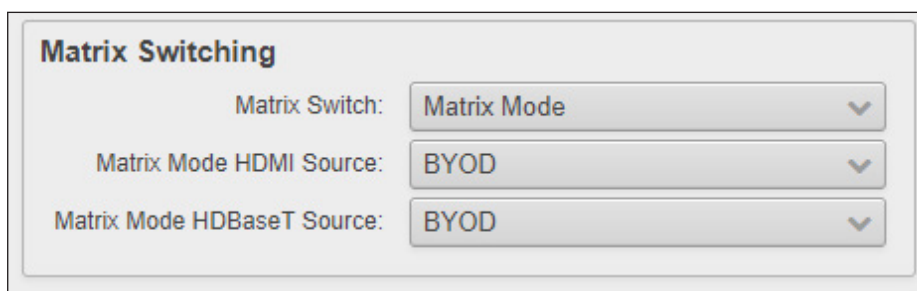

5. Click the **Matrix Mode HDMI Source** drop-down list and select the input to be routed to the **HDMI OUT** port.

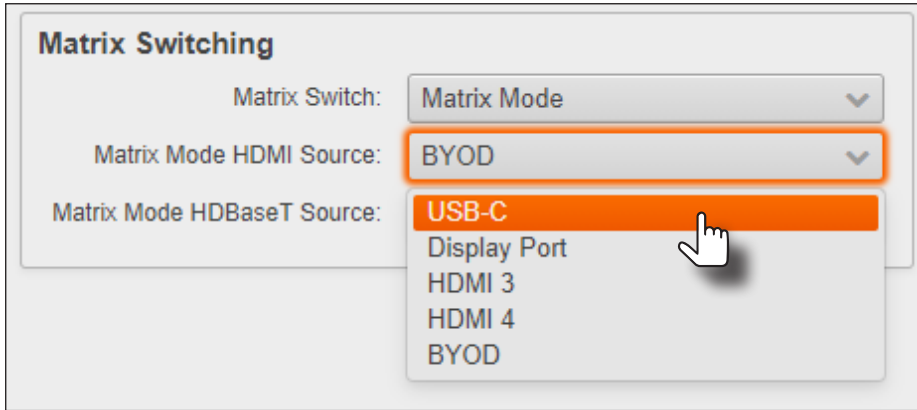

6. Click the **Matrix Mode HDBaseT Source** drop-down list and select the input to be routed to the **HDBaseT OUT** port.

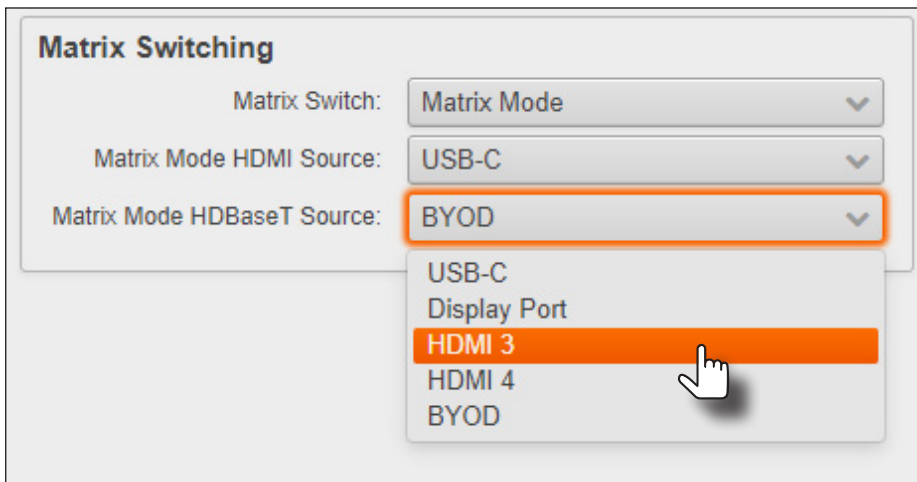

7. Matrix Mode configuration is complete.

 **NOTE:** If the input for **Matrix Mode HDBaseT Source** is not selected, then the input that was selected for the **Matrix Mode HDMI Source** will be also output on the **HDBaseT OUT** port.

Matrix Mode w/ Static Route

This mode is desirable when integrating the AT-UHD-SW-510W with a video conference system and allows for auto switching and display control. In this mode, both static input and output routing are specified. **Auto-Switching** (page 29) must be enabled. However, the specified static input will be removed from the auto-switching pool. For example, if the **HDMI IN 3** port is specified as a static input, then auto-switching will “skip” this port when auto-switching.

1. Login to the web server. Refer to [Logging in to the Web Server](#) (page 20) for more information.
2. Click **Routing** in the side menu bar.
3. Click the **Matrix Switch** drop-down list and select **Matrix Mode w/static route**.

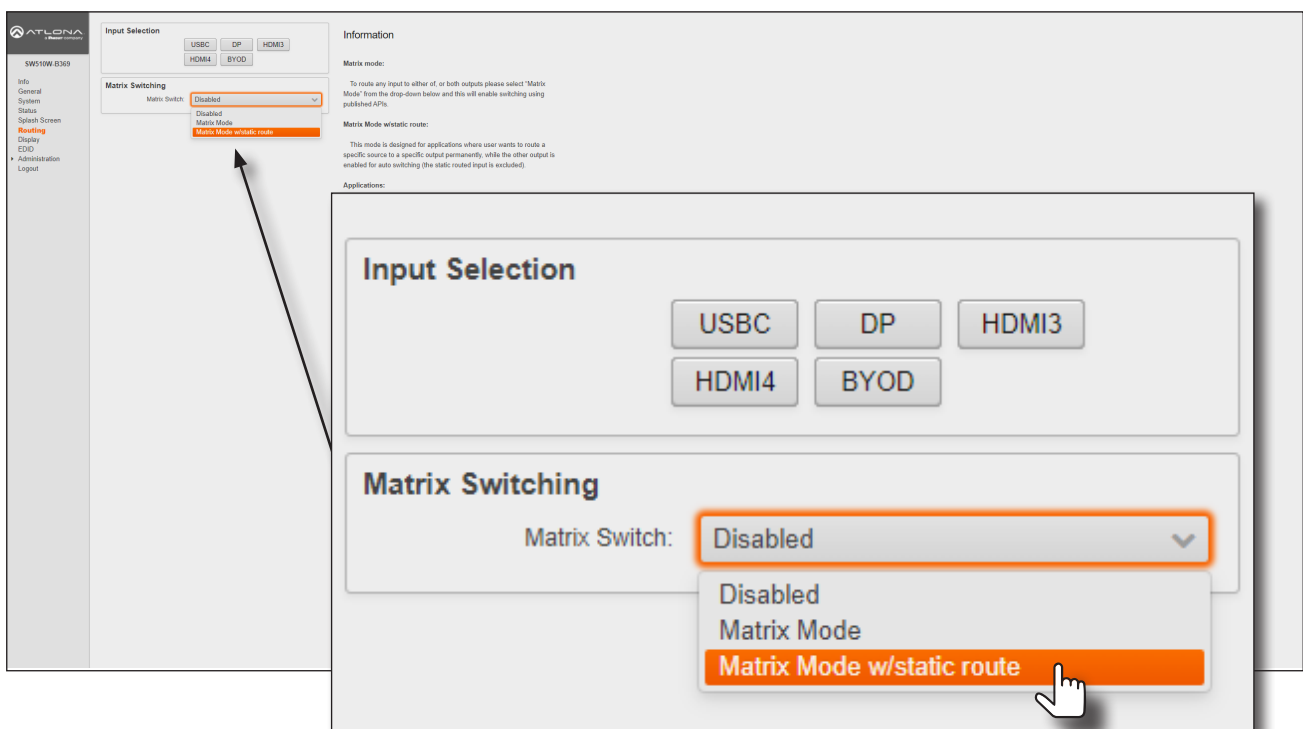

4. The **Matrix Switching** window group now contains the following options:

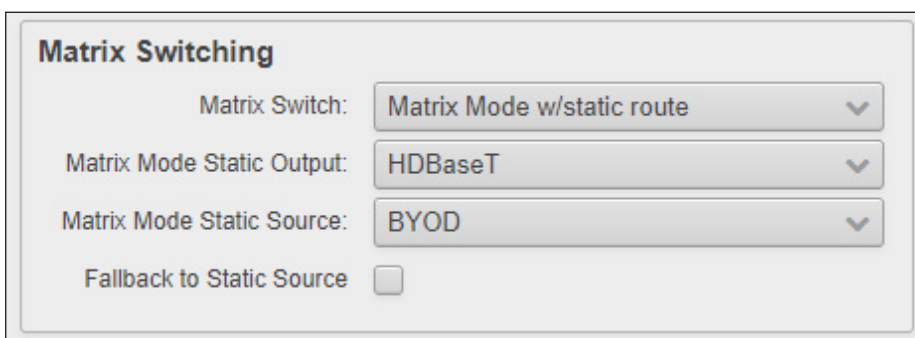

The **Fallback to Static Source** option is used to set the fallback input. Normally, the input would fallback to **BYOD** if no source was present. However, checking this box will allow the input to fallback to the source specified in the **Matrix Mode Static Source** drop-down list.

- Click the **Matrix Mode Static Output** drop-down list and select the output that will be “static”. This is the output that will not change.

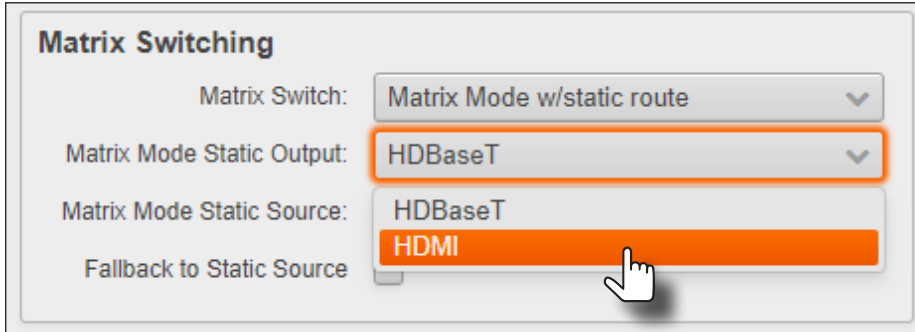

- Click the **Matrix Mode Static Source** drop-down to select the source that will be assigned as a “static” source. This source will be routed to the output selected in the **Matrix Mode Static Output** drop-down list.

In this example, the source connected to the Display port input, will be output to the HDMI output port.

INPUT 2 (DisplayPort) is the static source and **OUTPUT 1** (HDMI) is the static output. This particular configuration will allow the **USB-C** and both **HDMI IN** ports to be routed to the **HDBaseT OUT** port, as needed.

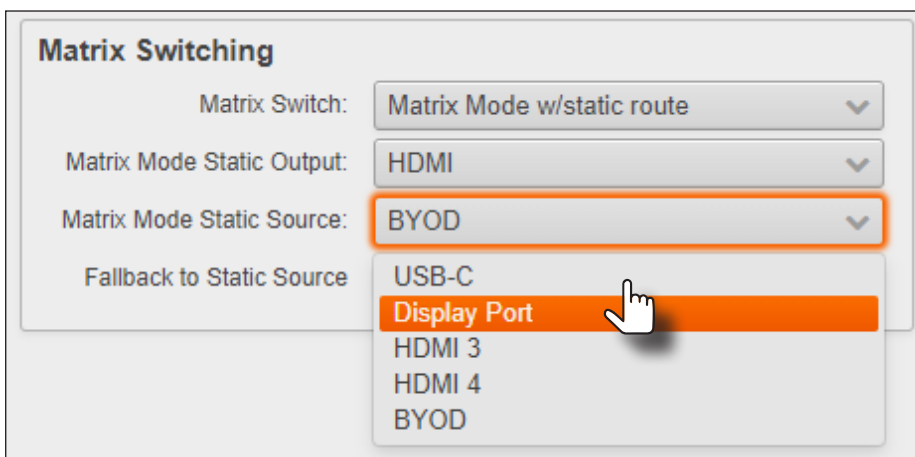

- Matrix with static route configuration is complete.

Auto-Switching

The AT-UHD-SW-510W provides auto-switching capability, which is enabled by default. This feature will automatically switch the input to the most recently-connected source. If a source is disconnected, then the input will automatically be switched to the previously-connected source.



IMPORTANT: The auto-switching feature is only available when the **Switching Mode** is set to **Matrix mode with static route** or **Disabled**. Refer to [Switching Modes \(page 25\)](#) for more information.

Enabling / Disabling Auto Switching

By default, auto-switching is enabled on the AT-UHD-SW-510W, allowing the unit to automatically switch between inputs when sources are connected or disconnected. Auto-switching is always enabled when set to **Matrix mode with static route** and cannot be disabled.

1. Login to the web server. Refer to [Logging in to the Web Server \(page 20\)](#) for more information.
2. Click **Display** in the side menu bar.
3. Under the **Control** window group, the **AutoSwitch** checkbox will be checked, indicating that auto-switching is enabled. If the **AutoSwitch** checkbox is grayed out, verify that the **Switching Mode** is set to either **Disabled** or **Matrix mode with static route**.
4. Click the **AutoSwitch** checkbox to remove the check mark to disable auto-switching. Note that if the previously active input is no longer available that it will fallback to any available input.



NOTE: The AT-UHD-SW-510W retains the currently selected input, even after the unit is powered-off then powered-on. The system should re-evaluate the auto switching logic after power on and select an input.

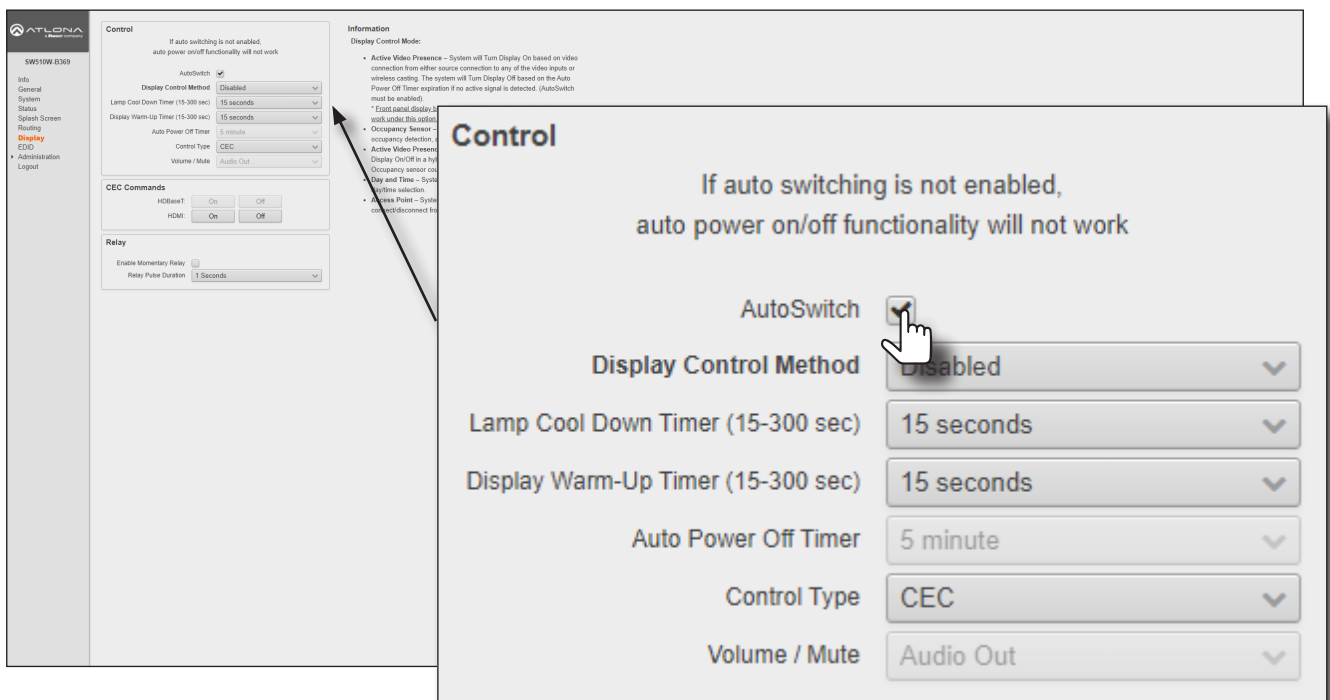

The screenshot shows the web interface for the AT-UHD-SW-510W. The left sidebar contains navigation options: Info, General, System, Status, Splash Screen, Routing, **Display**, EDID, Administration, and Logout. The main content area is titled 'Control' and includes a warning: 'If auto switching is not enabled, auto power on/off functionality will not work'. Below this, there is a section for 'AutoSwitch' with a checked checkbox. Other settings include 'Display Control Method' (Disabled), 'Lamp Cool Down Timer (15-300 sec)' (15 seconds), 'Display Warm-Up Timer (15-300 sec)' (15 seconds), 'Auto Power Off Timer' (5 minute), 'Control Type' (CEC), and 'Volume / Mute' (Audio Out). A callout box on the right side of the interface highlights the 'AutoSwitch' checkbox and the 'Display Control Method' dropdown menu, with a hand cursor pointing to the checkbox. The callout box also contains the same warning text and lists the other settings.

5. Auto switching configuration is complete.

The Splash Screen

The splash screen is displayed after the AT-UHD-SW-510W has completed the boot-up process, and indicates that the unit is ready for use. To view the splash screen, connect an HDMI cable to **OUTPUT 1** (HDMI) or **OUTPUT 2** (HDBaseT) on the AT-UHD-SW-510W to the HDMI input of a display.

Customizing Text

1. Login to the web server. Refer to [Logging in to the Web Server](#) (page 20) for more information.
2. Click **Splash Screen** in the side menu bar.

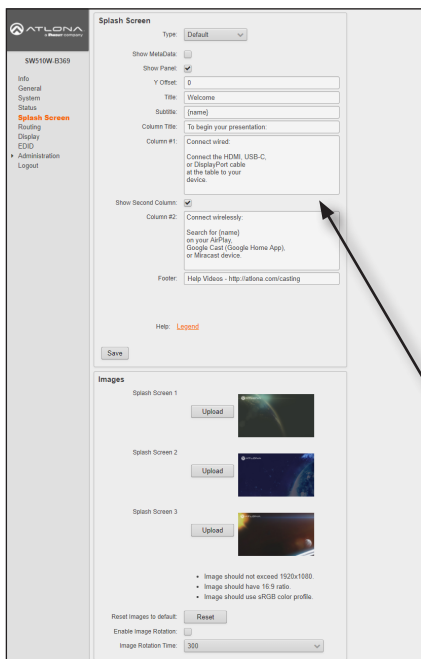

3. The **Splash Screen** window group has several settings. Note that the Column #1 and Column #2 fields provide default instructions on how to connect to the AT-UHD-SW-510W.

As with any fields in this window group, they can be customized to provide instructions for connecting to the AT-UHD-SW-510W in a specific environment.

The next page provides an illustration which identifies each of these fields, as they appear

Splash Screen

Type: Default

Show MetaData:

Show Panel:

Y Offset:

Title:

Subtitle:

Column Title:

Column #1:

Show Second Column:

Column #2:

Footer:

Help: [Legend](#)

Save



4. Refer to the previous page and make any desired changes to each field. Note that the “tag” {name} is present in the **Subtitle** field, by default. The value of {name} is a system value cannot be changed, as it identifies this specific device: MS52W. However, the {name} tag can be removed from the **Subtitle** field and replaced with other text.

Other tags, and a description of their values, are listed in the table below.

Tag	Description
{name}	This is the system name, and is usually the conference room/classroom name.
{ssid}	The name of the device when the AT-UHD-SW-510W is configured as an Access Point. Refer to Access Point Mode (page 41) for more information.
{eth0}	The IP address of the AT-UHD-SW-510W when connected to a network using an Ethernet cable.
{wlan0}	The IP address of the AT-UHD-SW-510W when using a wireless connection.
{version}	Displays the Master Firmware version.
{password}	Displays the Access Point password, when the AT-UHD-SW-510W is configured as an Access Point. If configured as an Access Point, this tag will be populated with the selected password. The password can be either static or dynamic. When set to dynamic, this field will be constantly updated. Refer to Access Point Mode (page 41) for more information.
{status}	The status of the AT-UHD-SW-510W.
{image:status}	The graphical status of the device (when using HTML splash screens).
{url:status}	The URL of image status (when using HTML splash screens).

- Click the **Legend** link to display a list of these tags at any time.

Splash Screen

Type: Default ▼

Show MetaData:

Show Panel:

Y Offset:

Title:

Subtitle:

Column Title:

Column #1:

Legend

{name}:	Copy "Name" from General tab
{ssid}:	Derived Name from General tab
{eth0}:	IP address from Wired Ethernet
{wlan0}:	IP address from Wireless Connection
{version}:	Master Firmware Version
{password}:	WiFi Access Point Mode Password
{status}:	Textual status of the device
{image:status}:	Graphical status of the device (For use in HTML)
{url:status}:	URL of Image status (For use in HTML)

Help: [Legend](#)

Save

- The **Y Offset** field is used to adjust the horizontal centering of the panel. The default value is 0 (center). Positive values will shift the panel to the right. Negative values will shift the panel to the left. Adjusting the **Y Offset** does not move the background image of the splash screen.
- Click the **Save** button to commit all changes within the **Splash Screen** window group.

Displaying Metadata

Click the **Show MetaData** checkbox to display metadata information on the splash screen. Metadata includes the name of the unit, model, current date, wired IP address, current firmware version, and some image references used by the AT-UHD-SW-510W.

1. Login to the web server. Refer to [Logging in to the Web Server \(page 20\)](#) for more information.
2. Click **Splash Screen** in the side menu bar, then click the **Show MetaData** checkbox. A check mark in this box indicates that the feature is enabled, and metadata will be displayed on top of the splash screen.

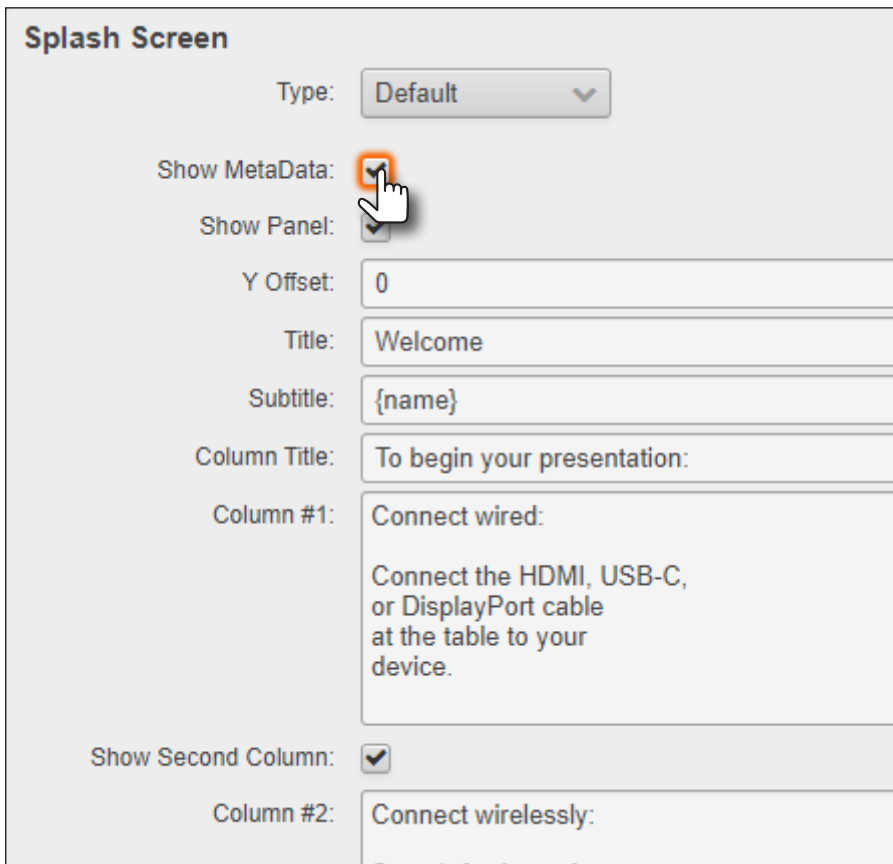

An example of metadata is shown below.

```

Name: SW510W-B369
Model: SW510W
Date: 11/19/2020
Wired IP: 10.0.1.83
Version: 2.9.0
LED - Grey: /opt/tomcat/webapps/ROOT/static/images/icons/led_grey_small.png
LED - Grey: <image src="{url:led_grey}">
LED - Green: /opt/tomcat/webapps/ROOT/static/images/icons/led_green_small.png
LED - Green: <image src="{url:led_green}">
LED - Red: /opt/tomcat/webapps/ROOT/static/images/icons/led_red_small.png
LED - Red: <image src="{url:led_red}">
LED - Status: {image:led_green}
LED - Status: {url:led_green}
Status: Ready
  
```

3. Click the **Save** button, at the bottom of the **Splash Screen** window group, to commit changes. To hide the metadata, uncheck the **Show MetaData** checkbox and click the **Save** button.

Displaying the Wireless Password

This feature is applicable only when the AT-UHD-SW-510W is configured as an *access point*. The wireless password can be displayed as part of any text field on the splash screen, by inserting the `{password}` tag as part of a text string. For example:

“To begin your presentation, connect using the SSID and enter the following password: `{password}`.”

Note that when the AT-UHD-SW-510W is configured as an *access point*, the wireless password will automatically be displayed by default, at the bottom of the screen, as shown below. In addition to the password, the WiFi Name field represents the SSID of the AT-UHD-SW-510W and is used to identify the unit as an available access point. Refer to [Wireless Configuration \(page 41\)](#) for information on setting up a WiFi connection.



Cycling Background Images

Background image cycling can prevent image persistence, which is the equivalent of image burn-in on CRT and plasma computer monitors.

1. Login to the web server. Refer to [Logging in to the Web Server \(page 20\)](#) for more information.
2. Click **Splash Screen** in the side menu bar.
3. Under the Images window group, click the **Enable Image Rotation** checkbox.

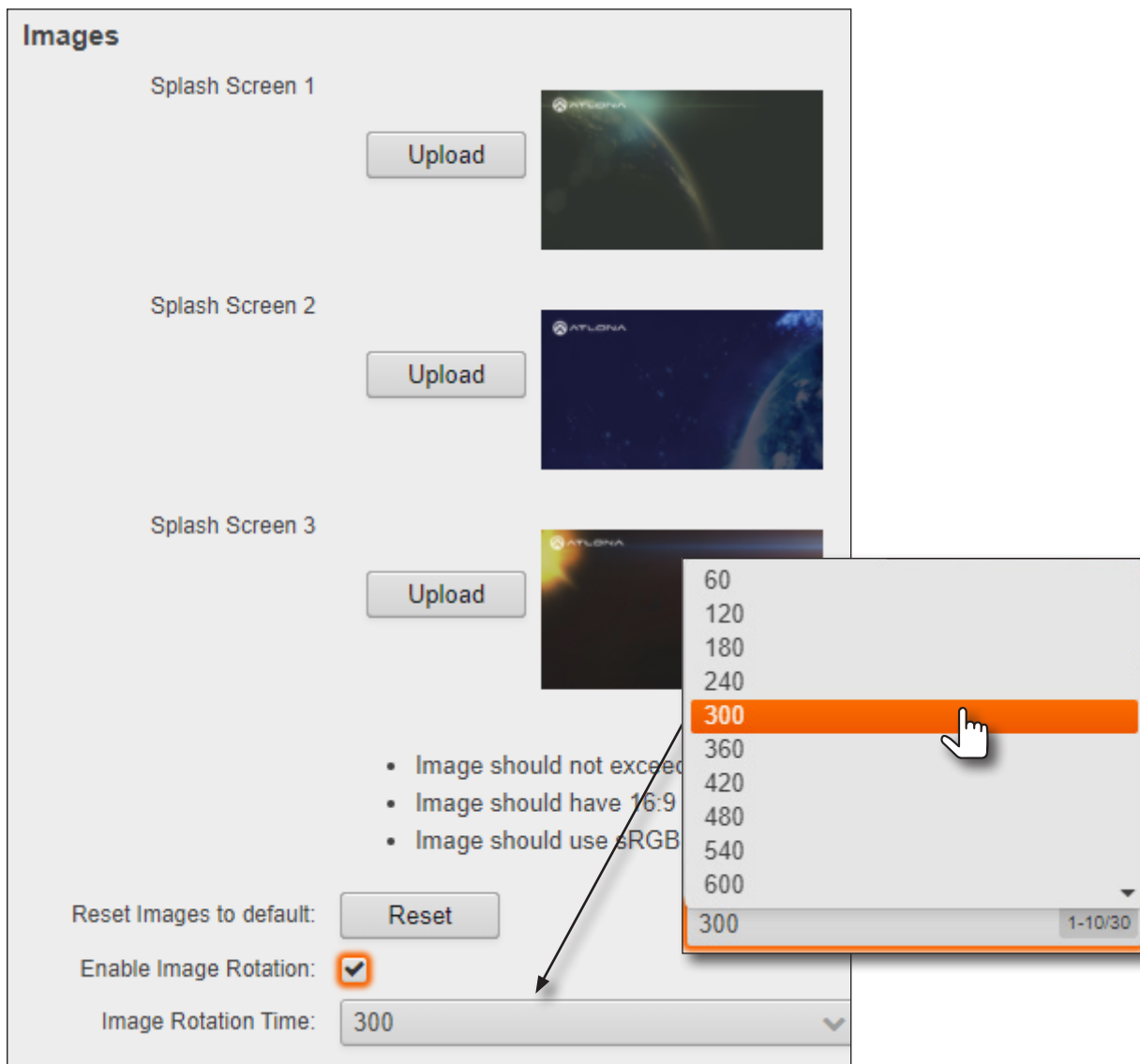

4. Click the **Image Rotation Time** drop-down list to select the desired time interval. Range: 1 - 10 minutes. The default image cycling time is 5 minutes (300 seconds). To disable image cycling, uncheck the **Enable Image Rotation** checkbox.

Uploading Custom Images

Custom images may be uploaded and used instead of the factory splash screens.

 **IMPORTANT:** Custom images should not exceed 1920 x 1080. All common image types, such as JPG, BMP, PNG, TIF, GIF, are supported.

1. Login to the web server. Refer to [Logging in to the Web Server \(page 20\)](#) for more information.
2. Click **Splash Screen** in the side menu bar.
3. Under the **Images** window group, click the **Upload** button next to the image to be changed.

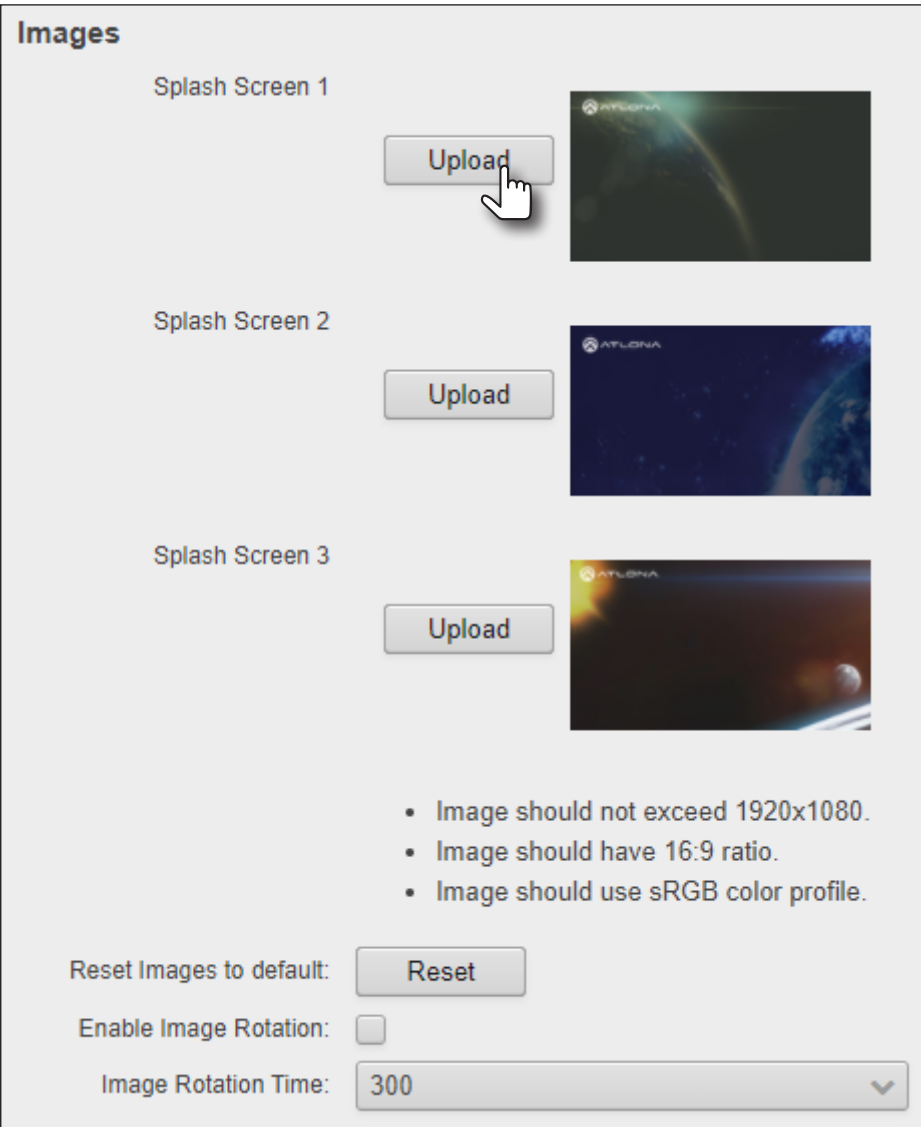

Images

Splash Screen 1 

Splash Screen 2 

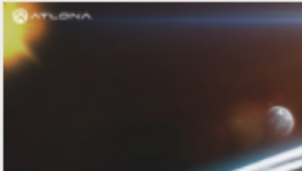
Splash Screen 3 

- Image should not exceed 1920x1080.
- Image should have 16:9 ratio.
- Image should use sRGB color profile.

Reset Images to default:

Enable Image Rotation:

Image Rotation Time: 300

4. Select the new image file and click the **Open** button on the dialog box. If viewing the currently active splash screen, the splash screen will be replaced with the uploaded image.
5. Repeat steps 3 and 4, as desired.

HTML Splash Screens

HTML-based splash screens can be used to create content-rich splash screens. This section provides details on creating and uploading an HTML splash screen. Familiarity with HTML is assumed. The AT-UHD-SW-510W comes with a default HTML splash screen, which can be downloaded from within the web server.

The following table provides a list of supported / unsupported features:

Feature	Supported	Not Supported
HTML5	●	---
Relative / absolute references	●	---
Dynamic images (e.g. animated GIF files)*	---	●
CSS	●	---
PHP, JavaScript, ASP (client/server-side processing)	---	●

* If a dynamic image is used, only the first frame of the image will be displayed on the splash screen.

Downloading the default splash screen

1. Login to the web server. Refer to [Logging in to the Web Server \(page 20\)](#) for more information.
2. Click **Splash Screen** in the side menu bar.
3. Under the **Splash Screen** window group, click the **Type** drop-down list and select **HTML**.

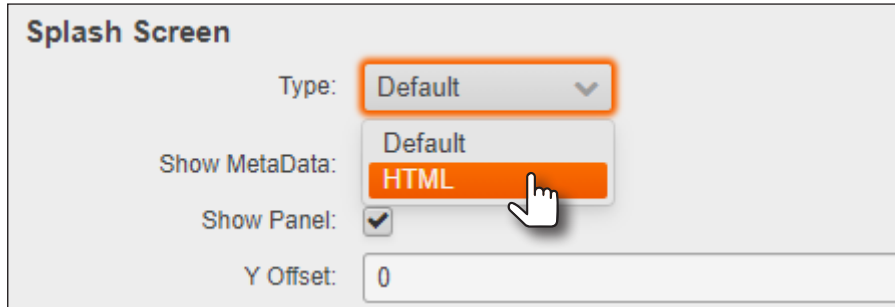

4. Click the **Download** button and save the `html.zip` file to a desired location on the computer.

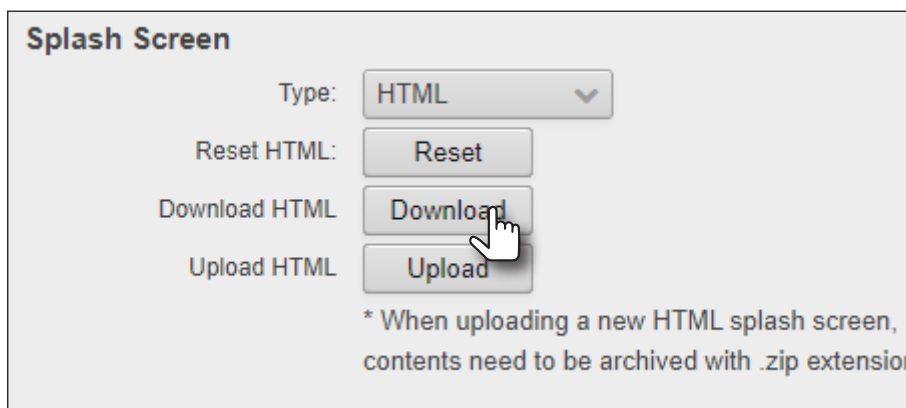

Once the file has downloaded, extract the contents to the desired folder. The included HTML file can be modified, as required, or a different HTML file may be used. The next page provides instructions and guidelines on creating a custom HTML file.

Using a custom HTML file

1. Create the HTML file, along with any links to the desired images. The AT-UHD-SW-510W also comes with a default HTML file (refer to the previous page), and can be used as a starting point when creating a custom HTML splash screen. The example below, is a partial listing of the HTML code within the default HTML file.



NOTE: When creating an HTML splash screen, it must be designed to fit a 1920x1080p display.

```
<HTML>
<head>
<style>
.container {
    position: relative;
}
.bottomleft {
    position: absolute;
    bottom: 64px;
    left: 64px;
    font-size: 25px;
}
.bottomright {
    position: absolute;
    bottom: 64px;
    right: 64px;
    font-size: 25px;
}
.icon {
    width: auto;
    height: 35px;
    vertical-align: middle;
}
.OutlineText {
    font: Tahoma, Geneva, sans-serif;
    font-size: 64px;
    color: white;
text-shadow:
...
...
}
...
...
</HTML>
```

2. Save the file as `index.html_template`. Do not add a file extension.
3. Combine the `index.html_template` file along with all required external images/files into a .zip file called `html.zip`.



IMPORTANT: The `index.html_template` file *must* reside in the root directory, within the `html.zip` file. Other files (.css, images, etc.) can be placed in folders, if desired, or can also be left in the root directory.

The file structure for the default `html.zip` file, located on the AT-UHD-SW-510W, is as follows:

```

airplay.png
cast.png
chrome.png
devices.png
index.html_template
wifi.png
windows.png
  
```

4. Login to the web server. Refer to [Logging in to the Web Server \(page 20\)](#) for more information.
5. Click **Splash Screen** in the side menu bar.
6. Under the **Splash Screen** window group, click the **Type** drop-down list and select **HTML**.

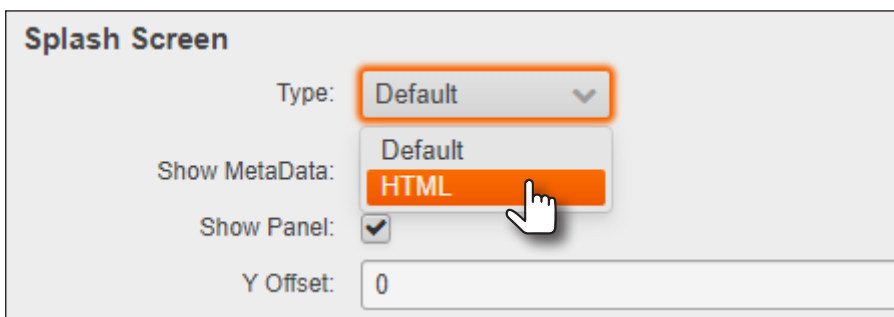

Splash Screen

Type: Default ▾

Show MetaData: Default
HTML

Show Panel:

Y Offset:

7. Click the **Upload** button.

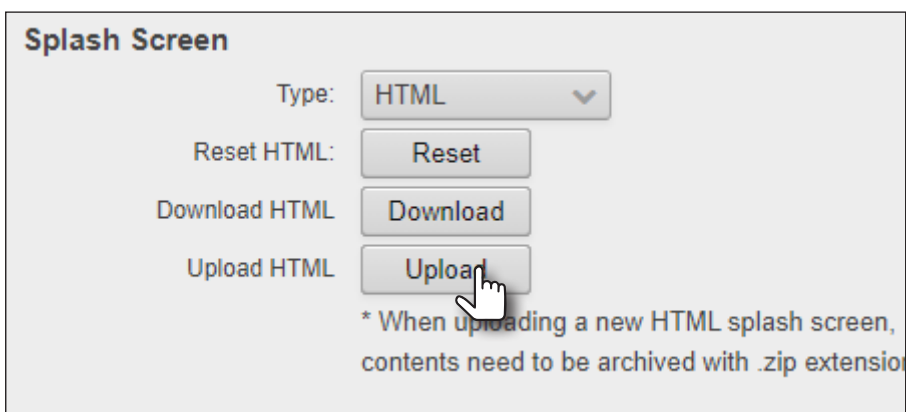

Splash Screen

Type: HTML ▾

Reset HTML: Reset

Download HTML: Download

Upload HTML: Upload

* When uploading a new HTML splash screen, contents need to be archived with .zip extension

8. Select the `html.zip` file, then click **Open**, to upload the file to the AT-UHD-SW-510W.
9. Click the **Save** button, at the bottom of the **Splash Screen** window group, to commit changes.

Resetting the HTML Splash Screen



IMPORTANT: The Reset (Reset HTML) button will delete any loaded HTML data and replace it with the default HTML page that comes with the AT-UHD-SW-510W.

1. Login to the web server. Refer to [Logging in to the Web Server \(page 20\)](#) for more information.
2. Click **Splash Screen** in the side menu bar.
3. Click the **Type** drop-down list and select **HTML**.
4. Under the **Splash Screen** window group, click the **Reset** button.

Splash Screen

Type:

Reset HTML:

Download HTML:

Upload HTML:

* When uploading a new HTML splash screen, contents need to be archived with .zip extension

Wireless Configuration

The AT-UHD-SW-510W features a wireless gateway, providing convenient Wi-Fi® connectivity to iOS, Android, Mac, Chromebook, or Windows-based devices. In addition, the AT-UHD-SW-510W can be configured as a wireless access point (AP). The addition of a built-in firewall provides filtering of outbound traffic from WAP to Ethernet.

Access Point Mode

When configured as an Access Point (AP), wireless devices can be connected to the AT-UHD-SW-510W.

1. Login to the web server. Refer to [Logging in to the Web Server](#) (page 20) for more information.
2. Click **Administration** > **Networking** in the side menu bar.
3. Under the **WiFi** window group, click the **Mode** drop-down list and select **Access Point**.

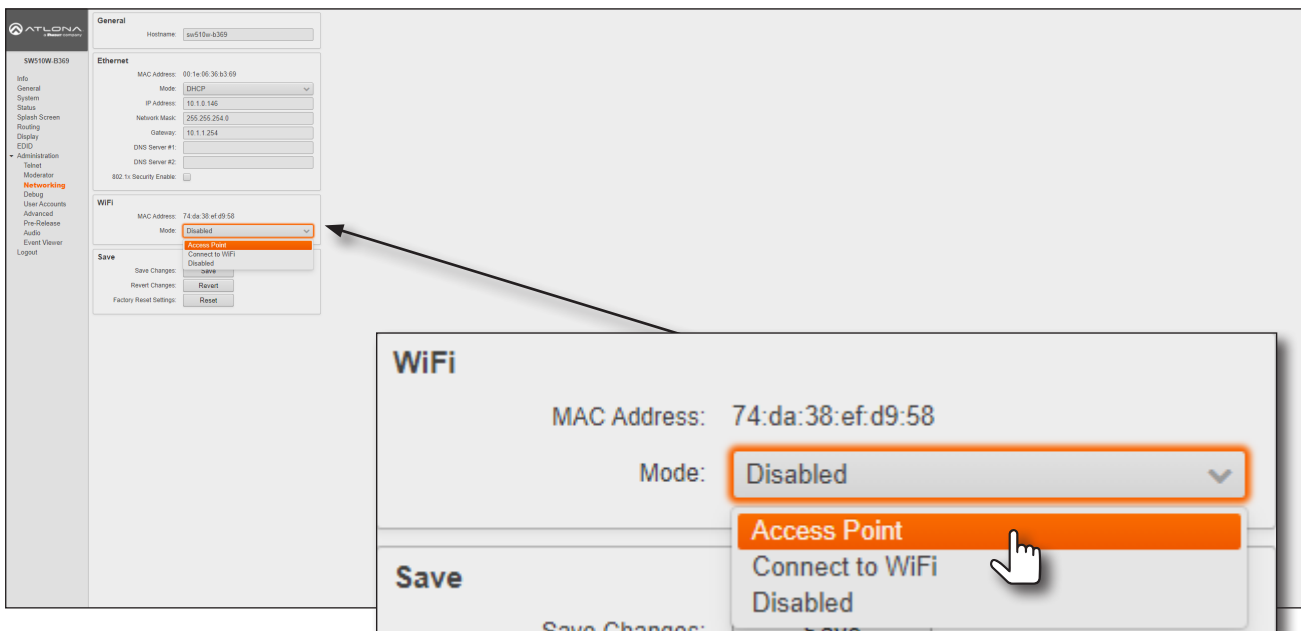

4. The name of the wireless network will appear in the **SSID** field. This name is identical to the text in the **Derived** field, under the [General](#) page (page 76). To change the SSID, go to the **General** page and modify the **Name** field.
5. Enter the password in the **Password** field. The password will be required by clients connecting to the AT-UHD-SW-510W. The default password is 12345678. Make sure to clear this value and provide a secure password.

IMPORTANT: If no password is supplied in Access Point mode, then any client will be able to connect to the AT-UHD-SW-510W without credentials. Make sure this is the desired operation before continuing. Also, if the Access Point is not secured, then the Miracast Infrastructure will not function, as it requires encryption of traffic.

WiFi

MAC Address: 74:da:38:ef:d9:58

Mode: Access Point

SSID: sw510w-b369

Password:

Device Operation

6. The **Show AP Credentials** checkbox is enabled by default. Enabling this feature will display the **WiFi Name** and **WiFi Password** fields to be displayed on the splash screen, as shown below. Uncheck this box to hide the name and password.

Show AP Credentials:	<input checked="" type="checkbox"/>
No Password in AP Mode:	<input type="checkbox"/>
Hide Password on OSD:	<input type="checkbox"/>
Rotate Password:	<input type="checkbox"/>

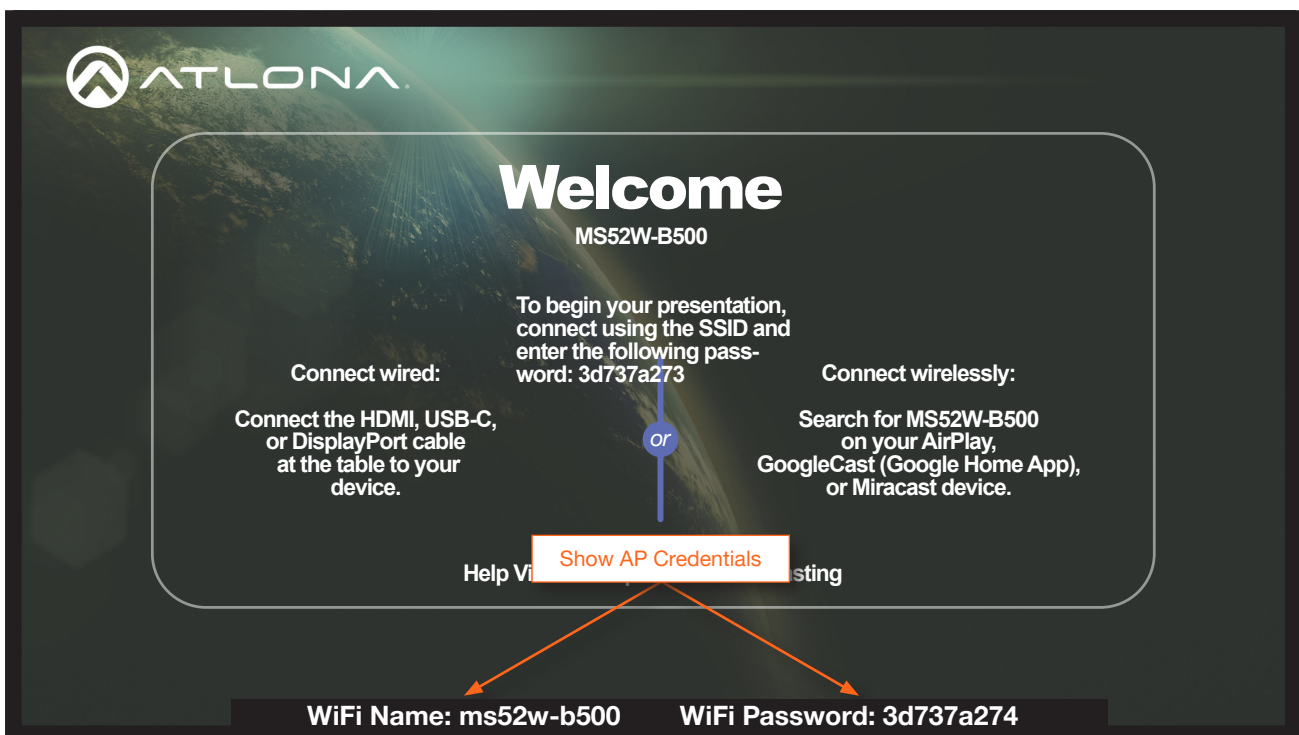

7. Check the **No Password in AP Mode** checkbox if no password credential is desired.
8. Click the **Hide Password on OSD** checkbox to prevent the **WiFi Password** field from being displayed.
9. Click the **Rotate WiFi Password** checkbox to allow the AT-UHD-SW-510W to generate a new random password.

This feature can be used to provide an extra level of security. Dynamically rotating the password decreases the risk that unauthorized clients will not have access to the AT-UHD-SW-510W, if the current password is “leaked” or observed on the splash screen, outside of a meeting space or other environment. It should be noted that the system will not change the password, once content is being presented, and will wait until the presentation is finished to begin password rotation. Check the **Hide Rotated Password** checkbox to hide rotated passwords.

10. Click the **Password Rotation Interval** drop-down list to select the rotation time interval for new password generation. The default setting is 1 hour.

Rotate Password:	<input checked="" type="checkbox"/>
Hide Rotated Password:	<input type="checkbox"/>
Password Rotation Interval:	1 hour

Device Operation

11. Enter the wireless channel number in the **Channel** field. Channels 1 through 11 are 2.5 GHz channels. Channels 36 and above are 5 GHz channels. Contact the network administrator if necessary.
12. Click the **Access Point Power Level** drop-down list to select the desired power level of the WiFi USB antenna. Available values are integers 0 through 13. Lower values will reduce transmission power of the USB WiFi antenna, thus limiting the range of the Access Point on the AT-UHD-SW-510W.
13. If a different set of DNS servers are desired, click the **DNS Mode** drop-down list and select the desired mode:

Feature	Description
Use default DNS Servers	Uses the default DNS provided by the DHCP server. This is the default setting.
Inherit from wired Network	Uses the same DNS provided by the wireless network.
Static	Enter the primary and secondary DNS addresses in the DNS Server #1 and DNS Server #2 fields, respectively.

14. The Firewall Mode drop-down list allows filtering of outgoing network traffic, from/to a network that is connected to the **LAN** port on the AT-UHD-SW-510W. Refer to [Firewall Mode \(page 44\)](#) for more information.
15. Click the **802.1x Security Enable** checkbox to enable 802.1x. Refer to [802.1X Authentication \(page 49\)](#) for more information.

Channel:	48	▼
Access Point Power Level:	0	▼
DNS Mode:	Use default DNS Servers	▼
DNS Server #1:	8.8.8.8	
DNS Server #2:	8.8.4.4	
Firewall Mode:	None	▼
802.1x Security Enable:	<input type="checkbox"/>	

16. To commit changes, click the **Save** button, located under the **Save** window group.

Save	
Save Changes:	<input type="button" value="Save"/>
Revert Changes:	<input type="button" value="Revert"/>
Factory Reset Settings:	<input type="button" value="Reset"/>

Firewall Mode

This feature allows filtering of outgoing network traffic, from/to a network that is connected to the **LAN** port on the AT-UHD-SW-510W. The AT-UHD-SW-510W provides the following firewall modes: **Block Private Network**, **Block Internet**, **Block All**, and **None**. If this feature is not desired, then the following steps can be skipped. The firewall can be configured or disabled at any time. The default setting is **None**.

1. Login to the web server. Refer to [Logging in to the Web Server \(page 20\)](#) for more information.
2. Click **Administration** > **Networking** in the side menu bar.
3. Under the **WiFi** window group, click the **Mode** drop-down list and select **Access Point**.
4. Click **Firewall Mode** drop-down list and select the desired option.

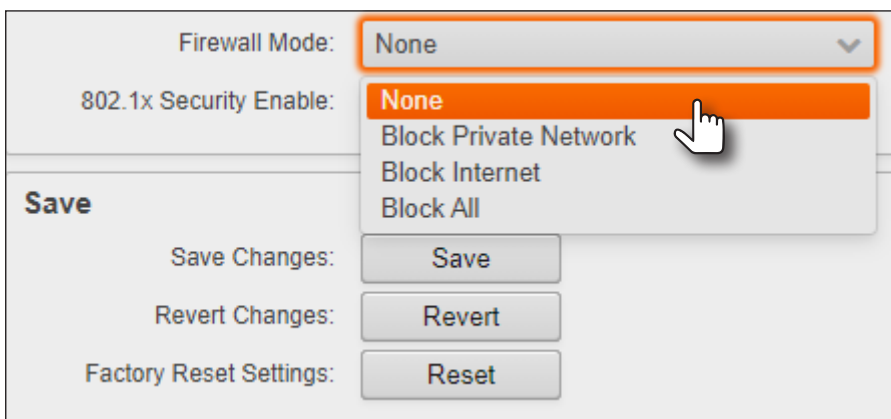

Setting	Description
None (default)	Select this option to disable the firewall on the AT-UHD-SW-510W and allow all outgoing network traffic.
Block Private Network	This option will globally block all private IP address ranges and traffic to the internal network on the LAN, except Internet access.
Block Internet	Allows wireless access to the AT-UHD-SW-510W and communication with the internal network, but prevents Internet access (Google, YouTube, etc).
Block All	All outbound network traffic is blocked. Wireless traffic to the AT-UHD-SW-510W is permitted, but no wireless data will be sent to the Ethernet port of the AT-UHD-SW-510W.

5. Click the **Save** button, under the **Save** window group, to commit changes.



Connect to WiFi Mode

Use this mode to connect the AT-UHD-SW-510W to another wireless network.

1. Login to the web server. Refer to [Logging in to the Web Server \(page 20\)](#) for more information.
2. Click **Administration** > **Networking** in the side menu bar.
3. Under the **WiFi** window group, click the **Mode** drop-down list and select **Connect to WiFi**.

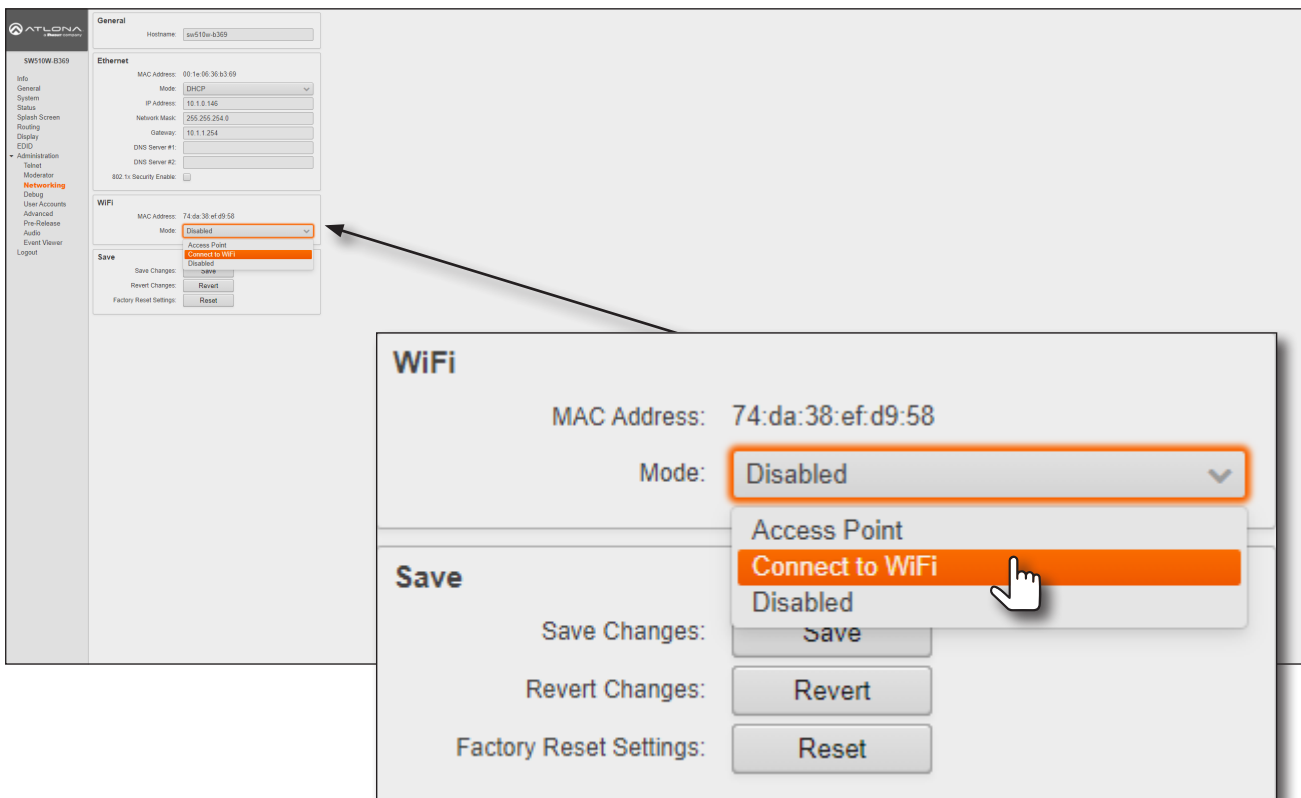

4. Click the **Preferred Gateway** drop-down list and select the desired gateway. When set to **Connect to WiFi** mode, the AT-UHD-SW-510W can only be accessed through the same network, over Ethernet or WiFi, not both. For example, if **Ethernet** is selected, then the AT-UHD-SW-510W can only be accessed from the same network over Ethernet. However, it should be noted that casting is supported on *both* interfaces, simultaneously.
5. Click the **Pick** button to display a listing of available WiFi networks.

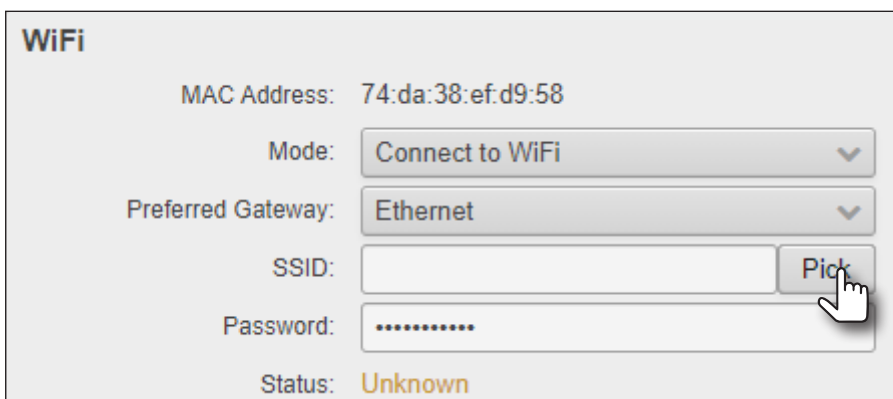

- Click the desired WiFi network from the list and click the **OK** button to accept the selection or click **Cancel** to return to the **WiFi** window group.

Pick a Wifi Network

Pick a Wifi Network to Connect

SSID: SSID

SSID	Str	
NETGEAR91	4	
NachoWiFi	4	
HP-Print-OfficeJet Pro 8600	3	
MK-WAP	3	
HuddleRm	3	
ConferenceRm-Main	3	
HuddleRm-5Ghz	3	
Lobby-Display	3	

- Enter the password for the wireless network in the **Password** field.

WiFi

MAC Address: 74:da:38:ef:d9:58

Mode:

Preferred Gateway:

SSID:

Password:

Status: **Unknown**

- Click the **Save** button near the bottom of the screen to commit changes.

Save

Save Changes:

Revert Changes:

Factory Reset Settings:

9. The system will prompt to be rebooted, as shown below. Click **Yes** to perform a reboot. To reboot at a later time, click the **Later** button.

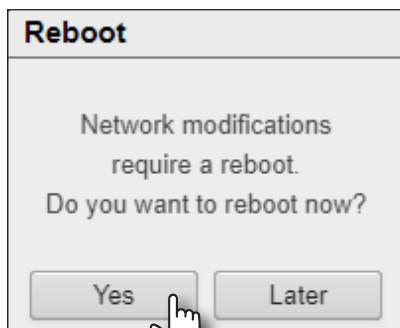

Once the connection has been established, the **Status** field will display *Connected*, as shown below.

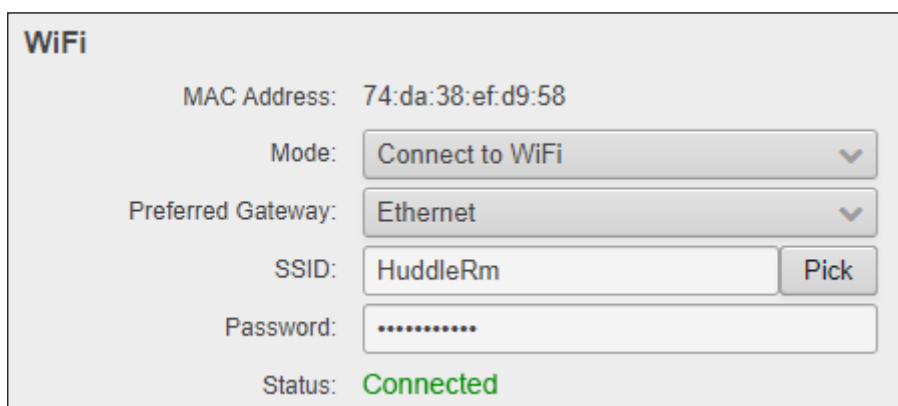

The following table provides a description of status messages.

State	Description
Connected	The AT-UHD-SW-510W is connected to the wireless network.
Not Connected	Unsuccessful connection. Check to make sure the password was entered correctly. This state will also occur if the wireless network, to which the AT-UHD-SW-510W is connected, is taken offline.
Unknown	The network state is unknown. This message is displayed if the AT-UHD-SW-510W has not been configured to connect with a wireless network.

Changing the SSID

By default, the SSID of the AT-UHD-SW-510W is set to the following identifier: `SW510W-{id}`. The first five digits are the last five characters of the product SKU. The `{id}` tag holds the last four digits of the MAC address. This identifier is held in the **Name** field, under the **General** tab. The AT-UHD-SW-510W copies the **Name** field to the **Derived** field, converting the characters to lowercase. The **Derived** field then becomes the SSID.

1. Login to the web server. Refer to [Logging in to the Web Server](#) (page 20) for more information.
2. Click **General** in the side menu bar.
3. Under the **General** window group, change the **Name** field to the desired name.
4. Click the **Save** button to commit changes.

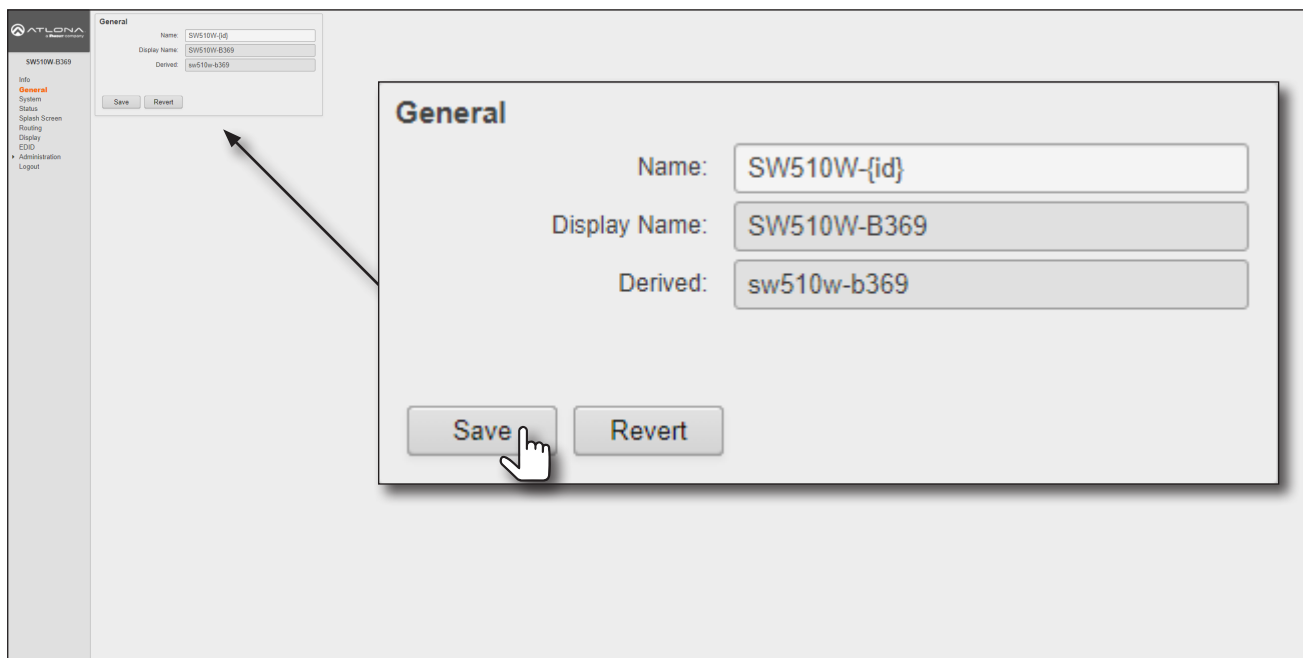

802.1X Authentication

802.1X is a server-based port authentication protocol which restricts unauthorized (rogue) clients from connecting to a Local Area Network through a public port. In its simplest form, 802.1X usually involves three parties: supplicant (client device), authenticator (Ethernet switch), and an authentication server. Before the device is permitted on the network, port communication is restricted to Extensible Authentication Protocol over LAN (EAPOL) traffic. If the device passes the authentication process, then the authentication server notifies the switch, allowing the client to access the LAN. A full explanation of the 802.1X protocol is beyond the scope of this manual. However, the illustration below shows the basic architecture.

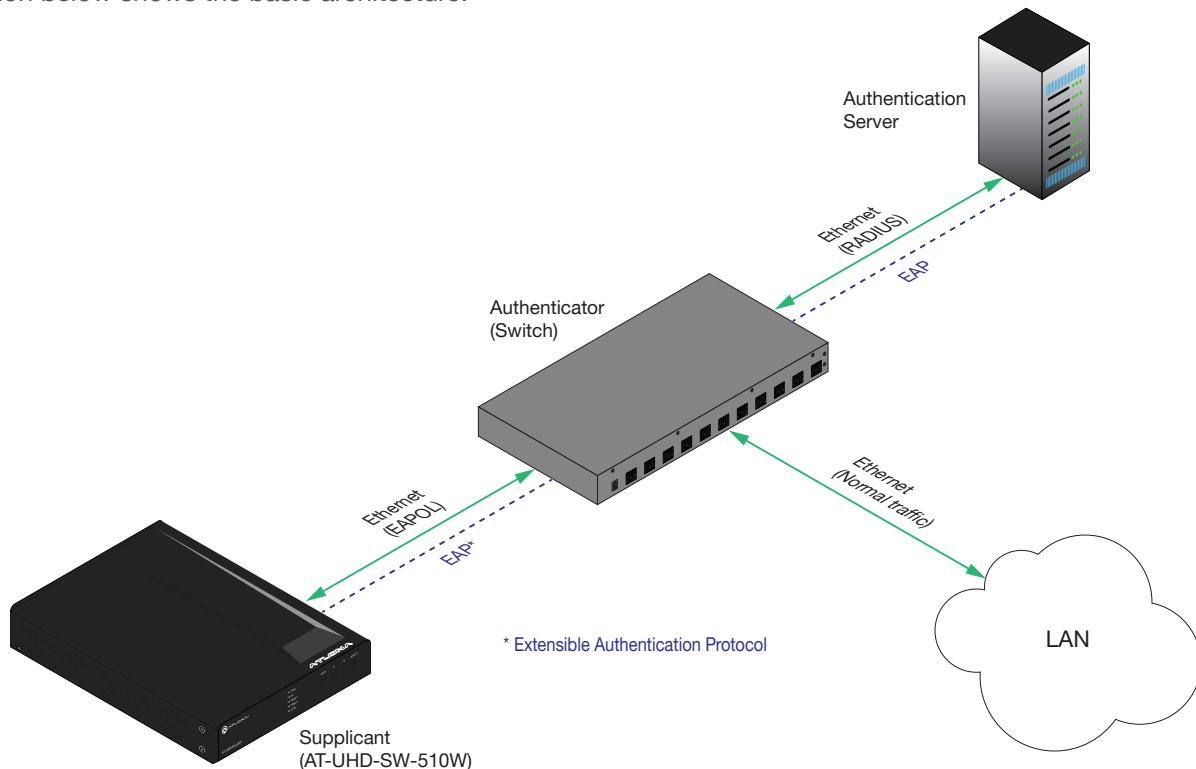

Ethernet Connections

1. Login to the web server. Refer to [Logging in to the Web Server](#) (page 20) for more information.
2. Click **Administration** > **Networking** in the side menu bar.
3. Make sure the Ethernet connection is working properly.
4. Under the **Ethernet** window group, click the **802.1x Security Enable** check box.

Ethernet

MAC Address: 00:1e:06:36:b3:69

Mode: DHCP

IP Address: 10.1.0.146

Network Mask: 255.255.254.0

Gateway: 10.1.1.254

DNS Server #1:

DNS Server #2:

802.1x Security Enable:

5. Enter the identity of the authentication server in the **Identity** field. EAP uses this field to identify the correct authentication server which will process the credentials. For example, if foo@authserv.com is entered, then this identifies AUTHSERV as the RADIUS (authentication) server.
6. Enter the password in the **Password** field.
7. Click the **Upload** button to select and upload the certificate.

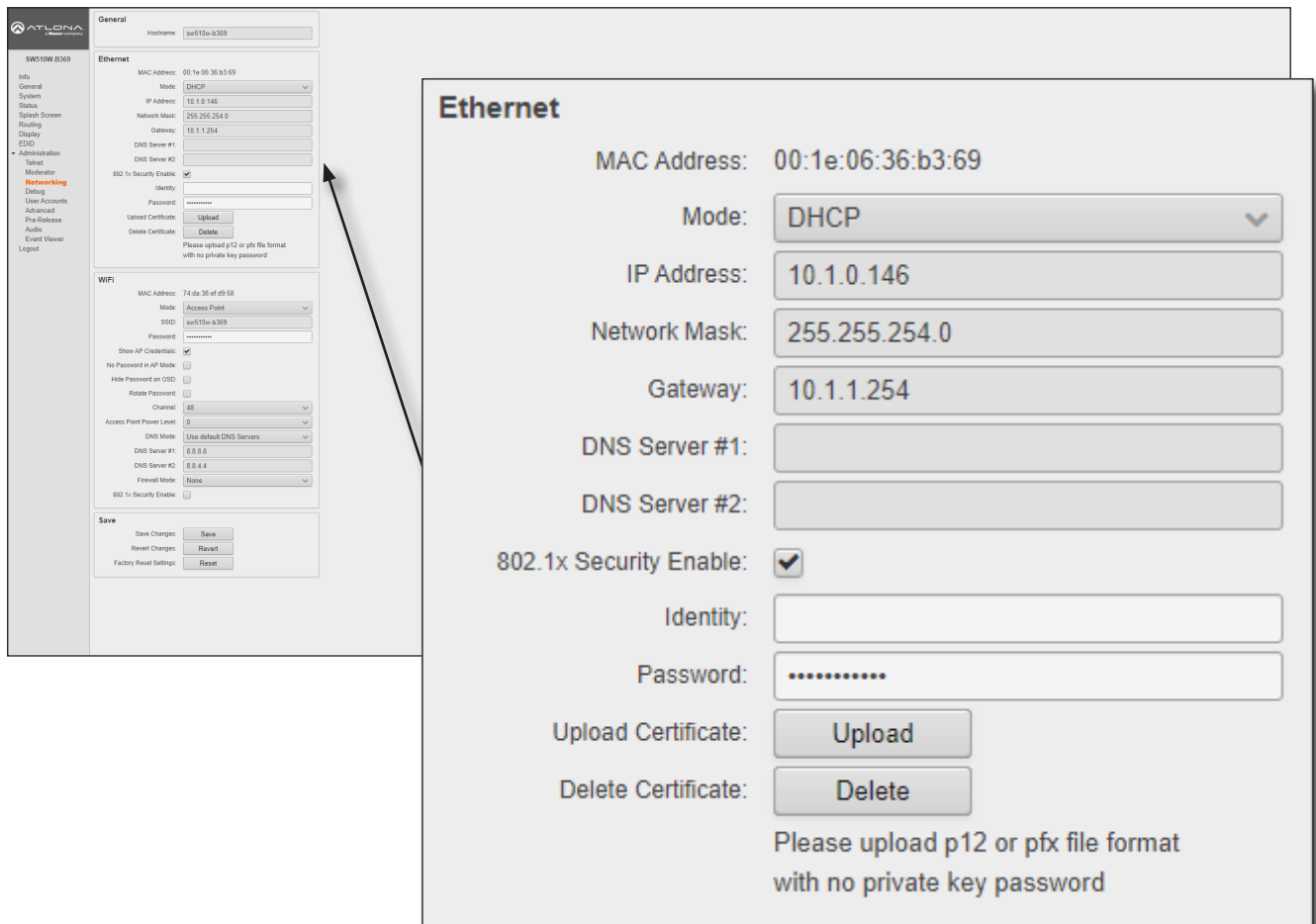

The screenshot shows the ATLONA web interface for device configuration. The left sidebar contains navigation options like Info, General, System, Status, and Administration. The main content area is divided into sections for Ethernet and WiFi. A callout box titled "Ethernet" provides a detailed view of the network settings:

- MAC Address:** 00:1e:06:36:b3:69
- Mode:** DHCP
- IP Address:** 10.1.0.146
- Network Mask:** 255.255.254.0
- Gateway:** 10.1.1.254
- DNS Server #1:** (empty)
- DNS Server #2:** (empty)
- 802.1x Security Enable:**
- Identity:** (empty text field)
- Password:** (masked with dots)
- Upload Certificate:** Upload button
- Delete Certificate:** Delete button

Below the callout box, a note states: "Please upload p12 or pfx file format with no private key password".

8. Under the Save window group, click the **Save** button to commit changes.



The screenshot shows the "Save" window group with the following options:

- Save Changes:** Save button
- Revert Changes:** Revert button
- Factory Reset Settings:** Reset button

WiFi Connections

1. Login to the web server. Refer to [Logging in to the Web Server](#) (page 20) for more information.
2. Click **Administration > Networking** in the side menu bar.
3. Under the **WiFi** window group, click the **802.1x Security Enable** check box.
4. Enter the server, port number, and the secret, in the **Radius Server**, **Radius Port**, and **Radius Secret** fields, respectively.

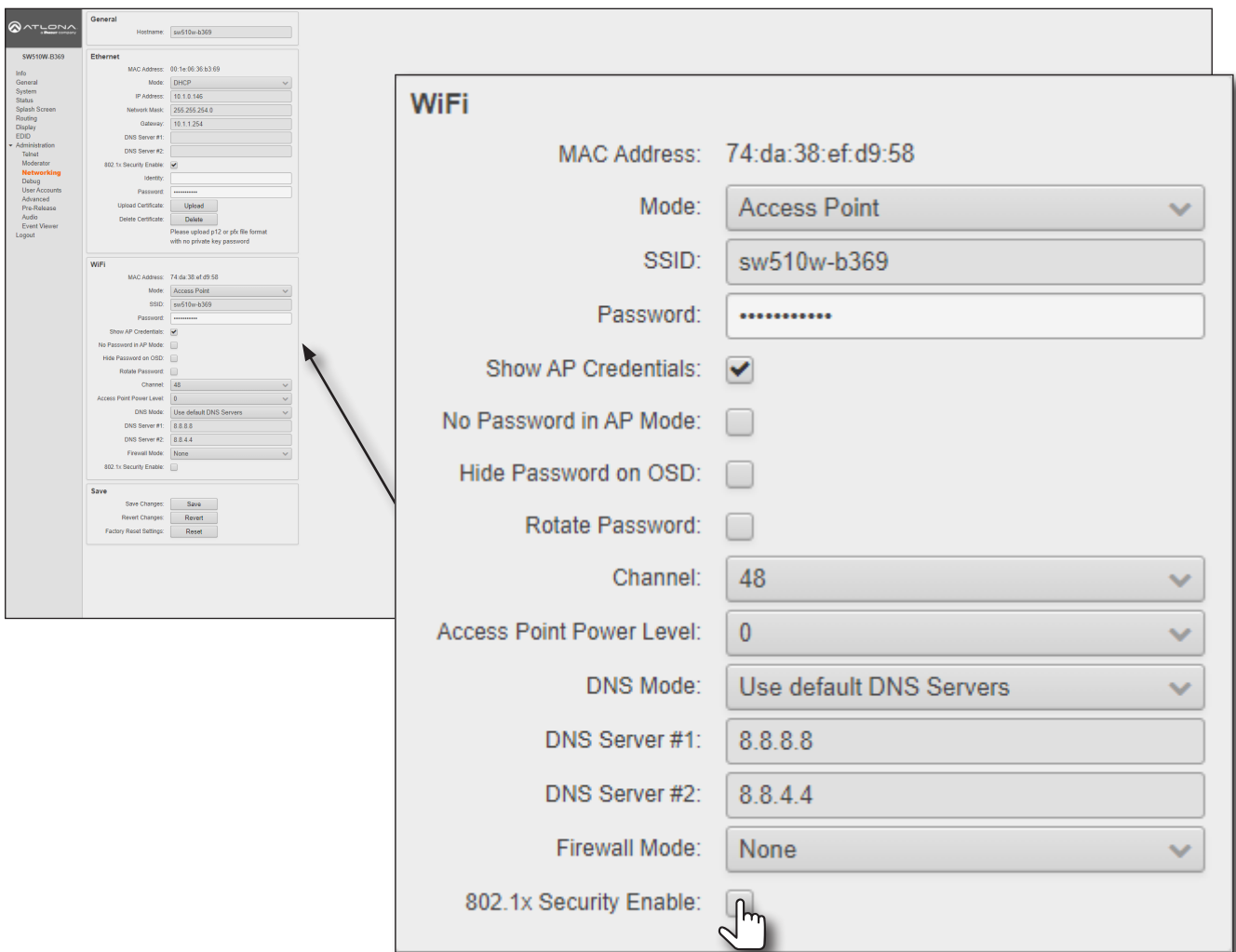

WiFi

MAC Address: 74:da:38:ef:d9:58

Mode: Access Point

SSID: sw510w-b369

Password:

Show AP Credentials:

No Password in AP Mode:

Hide Password on OSD:

Rotate Password:

Channel: 48

Access Point Power Level: 0

DNS Mode: Use default DNS Servers

DNS Server #1: 8.8.8.8

DNS Server #2: 8.8.4.4

Firewall Mode: None

802.1x Security Enable:

5. Click the **Save** button, under the **Save** window group, to commit changes.



Save

Save Changes:

Revert Changes:

Factory Reset Settings:

Casting

The AT-UHD-SW-510W interface provides the ability to transmit (“cast”) the screen of any iOS®, Android™, macOS®, Chromebook, or Windows device over Wi-Fi, without having to install a separate application or driver. The AT-UHD-SW-510W can serve as an integrated, dual-band access point, or be networked into an existing Wi-Fi installation.



IMPORTANT: Several apps have been known to trigger HDCP, even if the content is unprotected. In these cases, the AT-UHD-SW-510W will be unable to decode and present the content.

iOS Devices

AirPlay is only supported on iOS 10 or higher.

1. Select the **BYOD** input on the AT-UHD-SW-510W.
2. On the iOS device, go to **Settings > Wi-Fi**.
3. Select the network to which the AT-UHD-SW-510W is connected or join its access point. The example below shows the AT-UHD-SW-510W in **Connect to WiFi** mode. Refer to [Connect to WiFi Mode \(page 45\)](#) for more information.

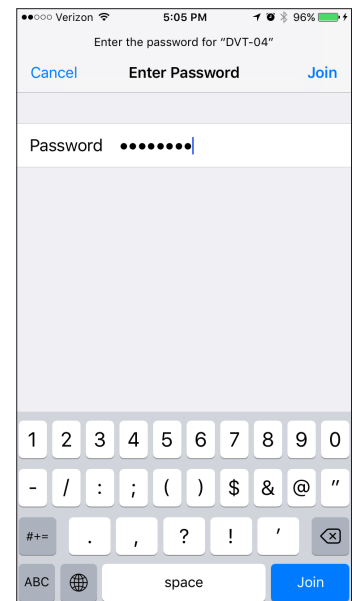
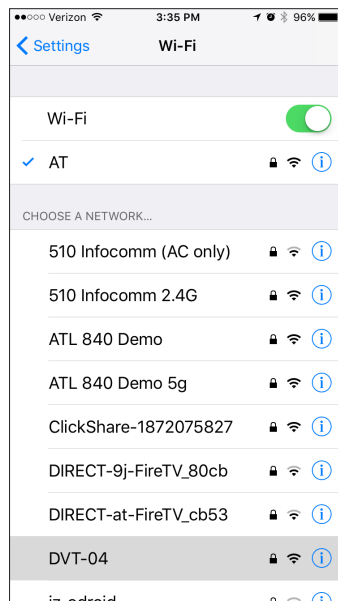

4. Once connected, swipe-up on the bottom of the iOS device to display the **Control Center**.
5. Tap the **AirPlay Mirroring** option to display a list of available AirPlay devices.

Note that if the iOS device is running 11.0.3 or later, the AirPlay option has been changed to Screen Mirroring. Tap the SSID from the list of devices.

iOS 10

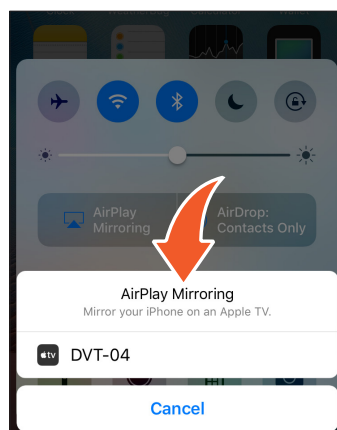

iOS 11.0.3 or later

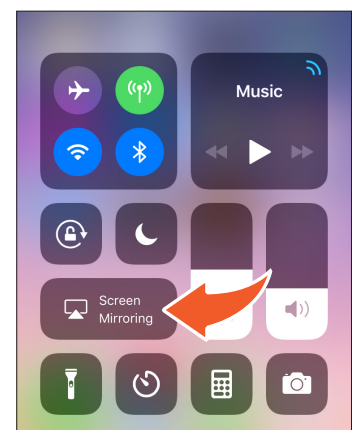

Device Operation

6. Tap the SSID from the list of devices.
7. Close the **Control Center** by either swiping down or pressing the **Home** button.
8. The image of the iOS device will now appear on the connected display.

Note that depending upon the application, the image on the screen can be rotated. For example, when using the camera app, if the iOS device is rotated 90 degrees, then the image on the screen will also be rotate 90 degrees.

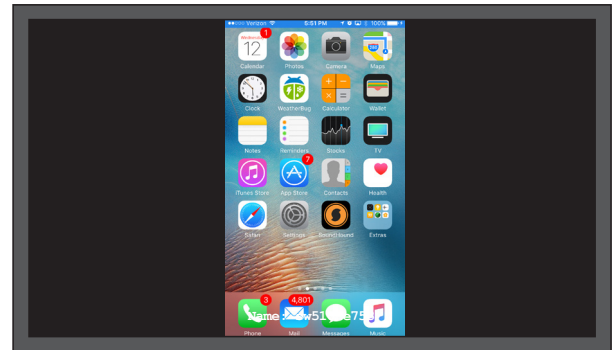

9. Close the **Control Center** by either swiping down or pressing the **Home** button.

OS X Devices

AirPlay® is only supported on Mountain Lion 10.8 or later. To determine if AirPlay is supported on the system being used, click **System Preferences > Displays**. If the “Show mirroring options in the menu bar when available” checkbox is not displayed, then AirPlay is not supported.

1. Click the **Wi-Fi** icon in the menu bar and select the network to which the AT-UHD-SW-510W is connected.

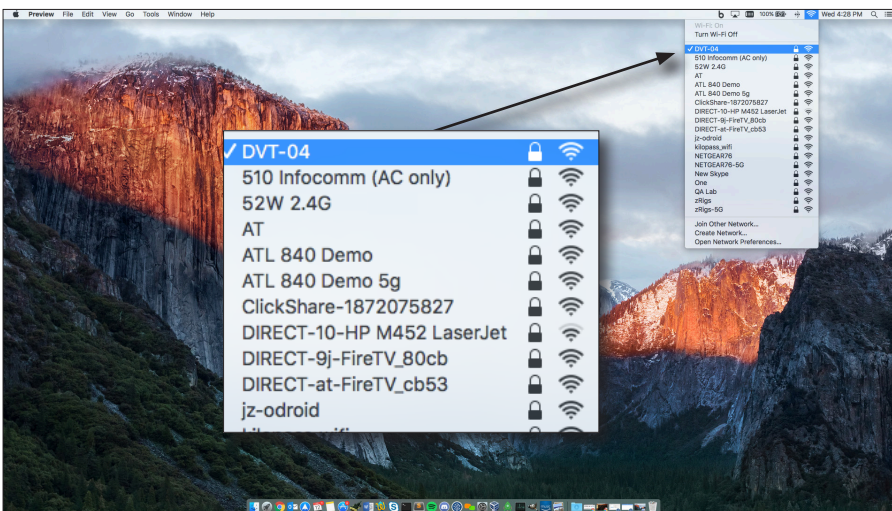

2. Enter the password for the Wi-Fi network, then click the **Join** button.



AirPlay can be used to either mirror or extend the Mac display.

- **Mirroring**
Click the AirPlay icon in the menu bar and select the desired display to be mirrored.
- **Extending**
Click the AirPlay icon and select “Use As Separate Display” from the list of displays, to extend the Desktop to another display.

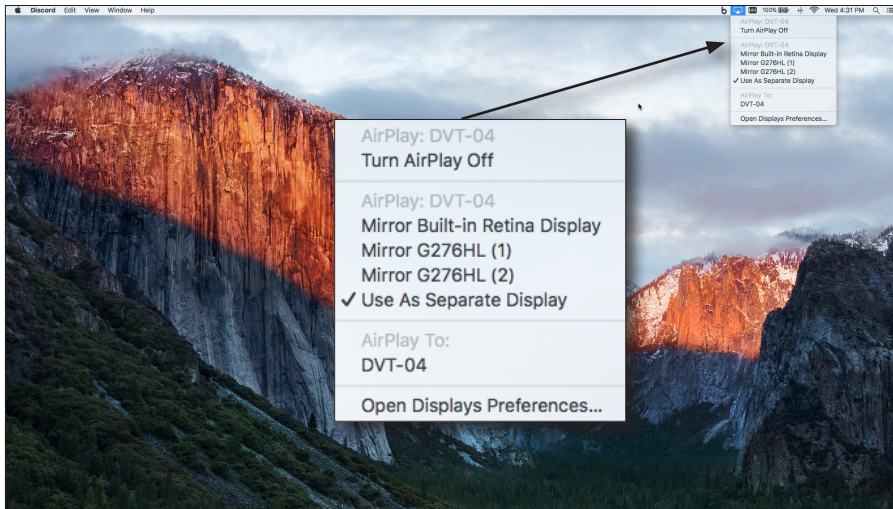



- **Turning Off AirPlay**
Click the AirPlay icon and select “Turn AirPlay Off”.

Microsoft Miracast

Miracast is a wireless protocol that allows content to be transmitted from laptops and other mobile devices to displays. The latest release of Microsoft Windows® 10 supports Miracast.

Displaying Miracast devices can be done in more than one way. Three methods are discussed below. The first method is the most direct method.

Method 1

1. Press  +  keys, simultaneously.
2. The list of available devices will be displayed on the right-hand side of the screen. Select the AT-UHD-SW-510W hostname from the list.

Method 2

1. Right-click on the Windows Desktop and select **Display Settings** from the pop-up menu.
2. In the right-hand column, scroll down, then click **Connect to a wireless display**.

Google Chrome

1. Make sure both the AT-UHD-SW-510W and the “casting” computer are on the same network.
2. Launch Google Chrome.
3. Click the  icon, in the upper right corner of the Chrome browser.
4. Click the **Cast...** option from the drop-down menu.
5. Select the hostname of the AT-UHD-SW-510W from the **Cast to** menu.

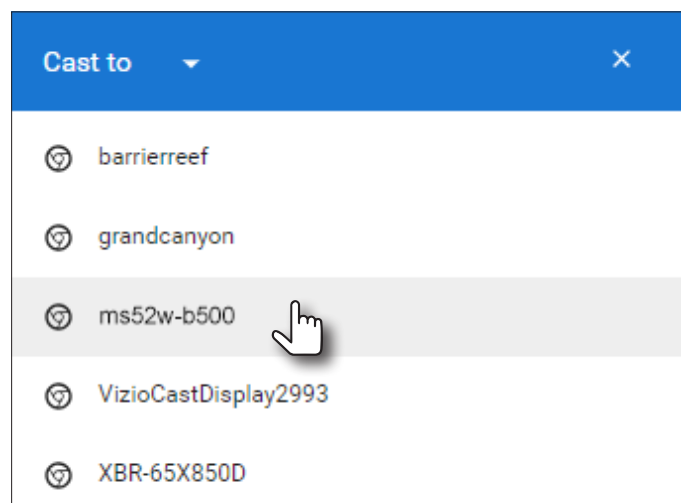
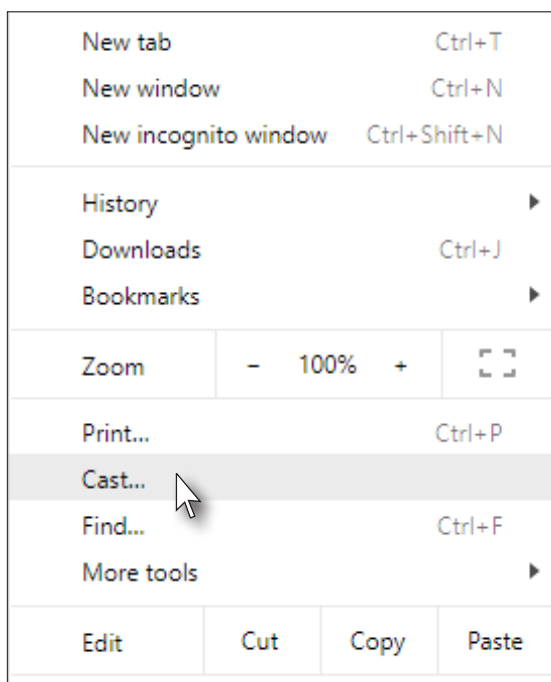

Chrome will immediately begin casting to the AT-UHD-SW-510W.

- Adjust the volume (if audio is present), by clicking and dragging the slider control. In addition, either **Remote screen** or **Both screens** can be selected from the **Show fullscreen videos on** drop-down list.
- Click the **x** in the upper-right corner of the Casting tab to dismiss this dialog.

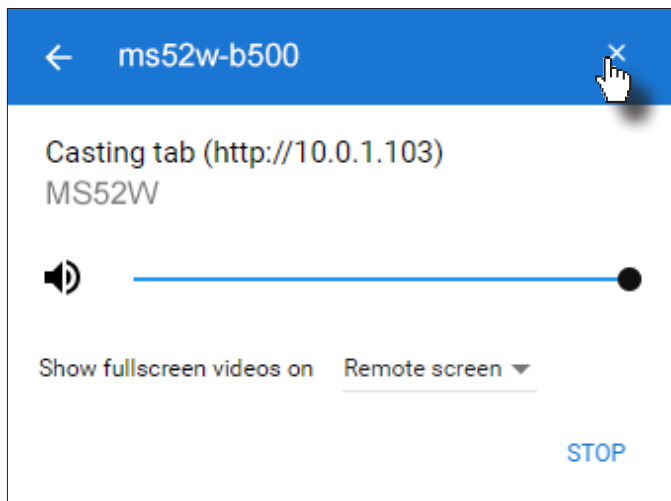

When Chrome is casting, the  icon will appear in the upper-right portion of the menu bar. Clicking this icon will display the Casting tab dialog.

In addition, a blue rectangle will be displayed in the browser tab, which is sharing (“casting”) the content to the AT-UHD-SW-510W. If the browser tab is closed, then the casting process will be terminated.

- Click **STOP** to discontinue casting to the AT-UHD-SW-510W.

Audio Management

By default, the AT-UHD-SW-510W will use the digital audio (if present) from the **USB-C IN**, **DisplayPort**, or **HDMI** ports and output the audio over the **HDMI OUT**, **HDBaseT OUT**, and **AUDIO OUT** ports. However, an external analog source can also be used. When configured, the analog audio source will replace the digital audio on the selected input, and will be heard on the **HDMI OUT**, **HDBaseT OUT**, and **AUDIO OUT** ports.

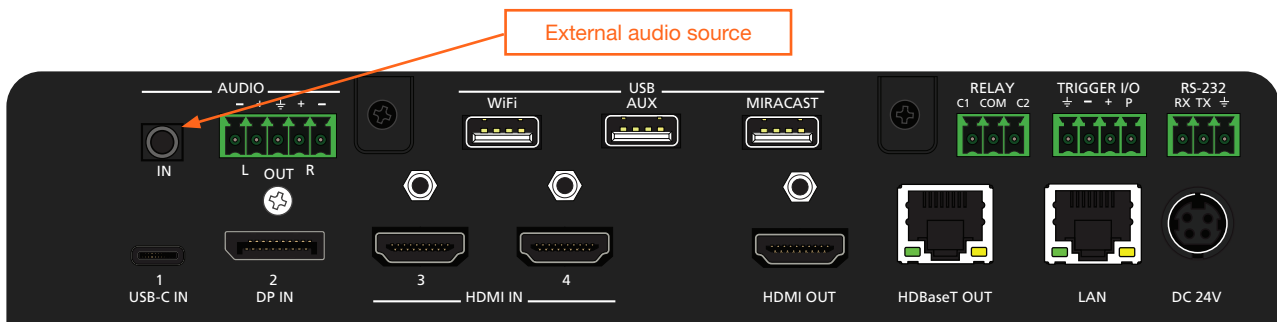

Using External Audio Sources

1. Connect an unbalanced audio source to the **AUDIO IN** port on the rear panel. This port accepts a 3.5 mm mini-stereo cable.
2. Login to the web server. Refer to [Logging in to the Web Server \(page 20\)](#) for more information.
3. Click **Administration** > **Audio** in the side menu bar.
4. Click the drop-down list of the desired input and select the audio input. In the example below, **Analog** is being selected from the **HDMI 4** drop-down list. This will replace the digital audio heard on the output (if any), with the analog audio source.

To use the digital audio from the HDMI source, select **Digital** from the **HDMI 4** drop-down list.

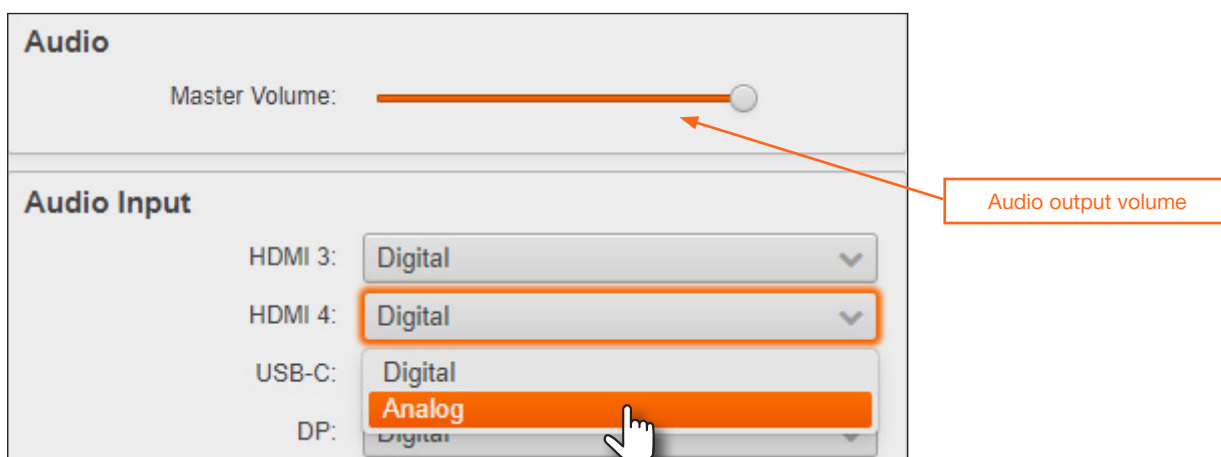

Controlling Audio Output Volume

1. Login to the web server. Refer to [Logging in to the Web Server \(page 20\)](#) for more information.
2. Click **Administration** > **Audio** in the side menu bar.
3. Under the **Audio** window group, click and drag the volume slider to the desired output level. This applies to both digital and analog (external) audio sources.

AirPlay Bluetooth Discovery

The AT-UHD-SW-510W supports Bluetooth®-assisted device discovery. An *optional* Bluetooth adapter is required, but not included. Atlona recommends Plugable and Kinivo Bluetooth 4.0 adapters.

IMPORTANT: Bluetooth discovery is applicable only to Apple devices and is used for device discovery on networks, such as corporate networks, where mDNS is not permitted. Bluetooth discovery behaves as a type of “beacon”, indicating the available AT-UHD-SW-510W units within the local vicinity of an AirPlay device.

1. Connect the Bluetooth adapter to the **AUX** port on the AT-UHD-SW-510W.
2. Login to the web server. Refer to [Logging in to the Web Server \(page 20\)](#) for more information.
3. Click **Administration** > **Advanced** in the side menu bar.
4. Under the **BYOD** window group, click the **AirPlay Bluetooth** checkbox. If this checkbox has a check mark in it, then the feature is enabled. Also, make sure that the **AirPlay Enable** checkbox is checked.

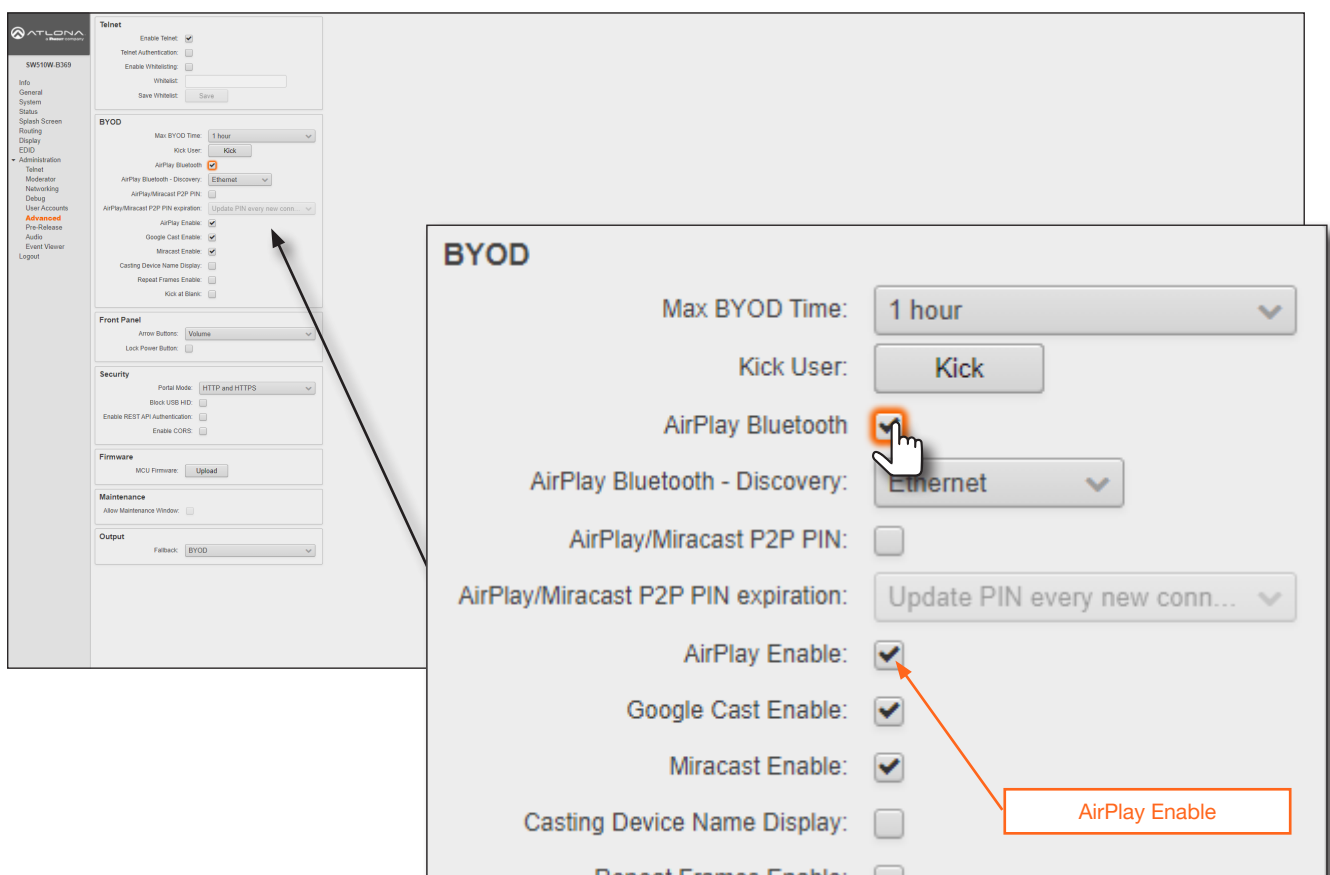

The screenshot shows the ATlona web interface for the AT-UHD-SW-510W device. The left sidebar contains a navigation menu with options like Info, General, System, Status, Splash Screen, Routing, Display, ESD, Administration, Telnet, Moderator, Networking, Debug, User Accounts, Advanced, Pre-Release, Audio, Event Viewer, and Logout. The main content area is divided into several sections: Telnet, BYOD, Front Panel, Security, Firmware, Maintenance, and Output. The BYOD section is expanded, showing various settings. A red box highlights the 'AirPlay Enable' checkbox, which is checked. An arrow points from this box to the 'AirPlay Bluetooth' checkbox, which is also checked. Other settings in the BYOD section include Max BYOD Time (1 hour), Kick User (Kick), AirPlay Bluetooth - Discovery (Ethernet), AirPlay/Miracast P2P PIN (disabled), and AirPlay/Miracast P2P PIN expiration (Update PIN every new conn...).

5. Go to the AirPlay device and activate Screen Mirroring. The AT-UHD-SW-510W will now be displayed in the Screen Mirroring device list.

NOTE: If the AT-UHD-SW-510W is beyond the range defined by the Bluetooth specification, then the device will not be displayed in the Screen Mirroring list. When pairing, make sure to be as close to the AT-UHD-SW-510W as possible.

AirPlay / Miracast P2P PIN Codes

The AT-UHD-SW-510W can be configured to prompt for a PIN code, before a BYOD device connects with either AirPlay or Miracast P2P. When this option is enabled, a PIN code will be displayed on the screen when an AirPlay or Miracast device attempts to connect to the AT-UHD-SW-510W. Refer to the IT Deployment Guide for definitions of Miracast P2P (Peer-to-Peer) and Miracast over Infrastructure.



NOTE: The PIN code will randomly change every five minutes, by default. This value can be set from 10 seconds to five hours. This provides a level of security, preventing unauthorized users from accessing the AT-UHD-SW-510W. Android™ devices do not support PIN code security.

1. Login to the web server. Refer to [Logging in to the Web Server \(page 20\)](#) for more information.
2. Click **Administration** > **Advanced** in the side menu bar.
3. Click the **AirPlay Enable** and **Miracast Enable** checkboxes, as required by the casting device.
4. Under the **BYOD** window group, click the **Airplay/Miracast P2P PIN** checkbox. If this checkbox has a check mark in it, then the feature is enabled.

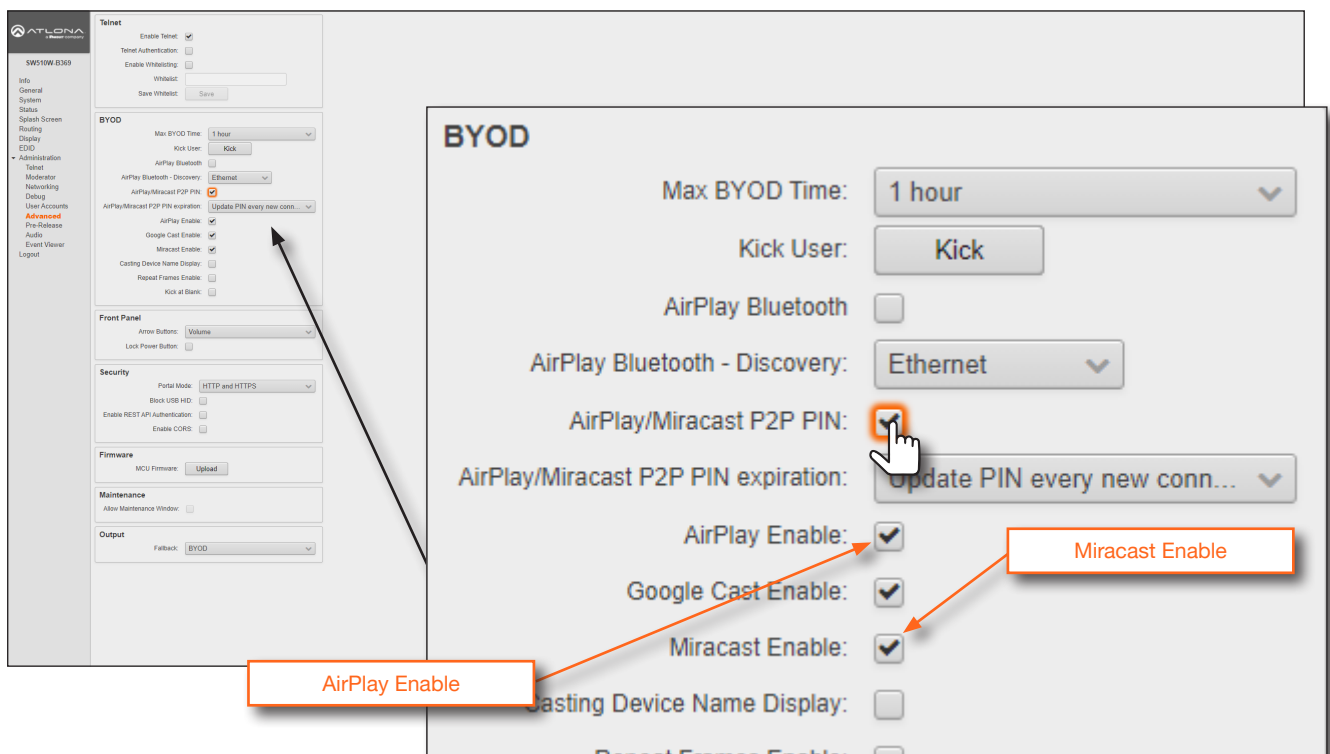

5. The following message box will be displayed. Click the **Ok** button.

Restart AirPlay/Miracast/Google Cast

AirPlay/Miracast P2P PIN modifications require a restart of AirPlay/Miracast/Google Cast and wireless services please wait a few minutes before casting again.

Device Operation

5. Connect the AirPlay/Miracast P2P device to the AT-UHD-SW-510W. Refer to [Wireless Configuration \(page 41\)](#) for more information.
6. Begin casting to the AT-UHD-SW-510W. When the device attempts to connect to the AT-UHD-SW-510W, a PIN code will be displayed on the screen that is connected to the device. Refer to the illustration on the next page, if necessary.

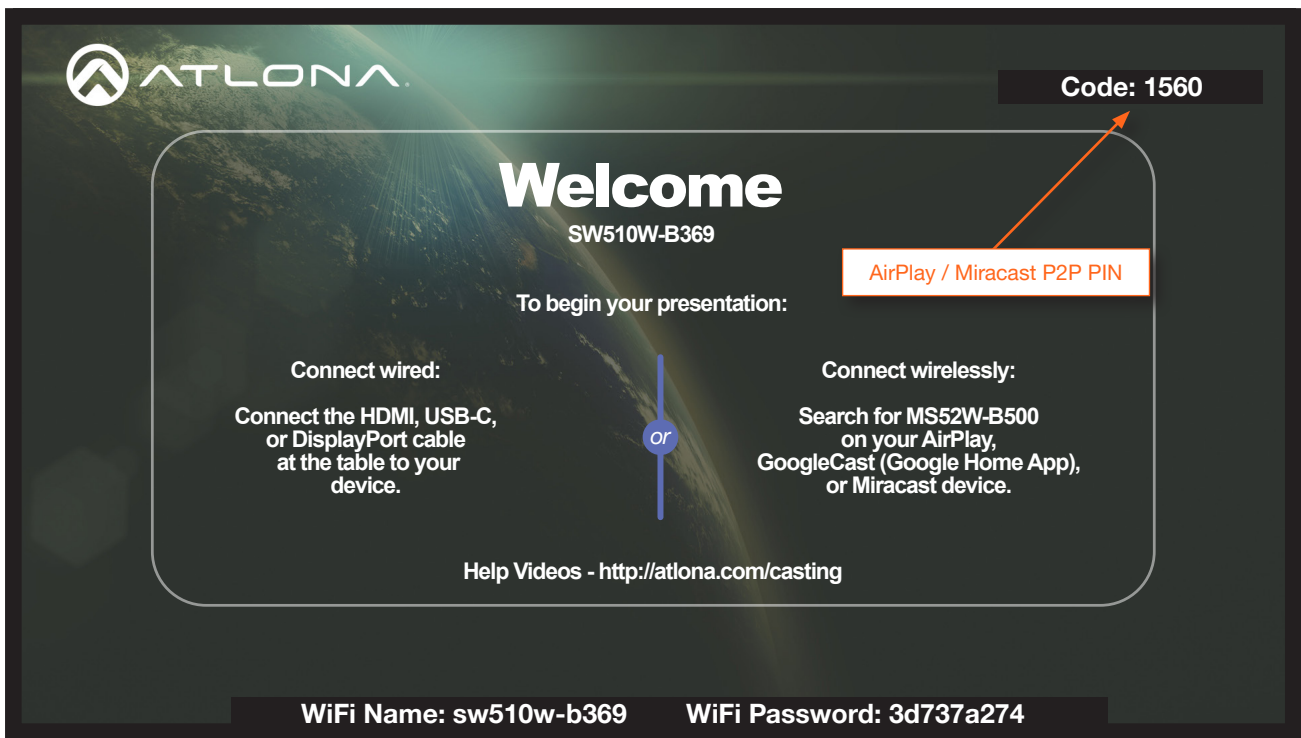

6. Enter the four-digit PIN code in the dialog box on the device and press **OK**. The PIN code will be displayed only for about 10 seconds. If the PIN code is not entered within the time interval, then the PIN code will be removed from the screen. The example below, shows an AirPlay device prompting for the PIN code. Clicking **Cancel** in the AirPlay Code dialog box will reconnect the AirPlay device to the AT-UHD-SW-510W and generate a new PIN code.

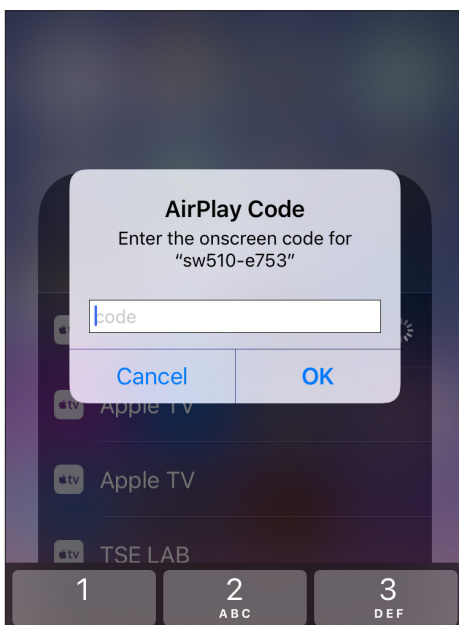

Changing the PIN Timeout

By default, the AT-UHD-SW-510W will automatically generate a new PIN code for each new WiFi connection that is attempted. However, this value can also be set to regenerate every 15 minutes or 60 minutes.



NOTE: The AT-UHD-SW-510W requires a minimum of 20 seconds to elapse before another PIN code is generated. For example, if another connection is made, within 20 seconds after the nth connection, then the same PIN code will be used to connect to the system.

1. Login to the web server. Refer to [Logging in to the Web Server \(page 20\)](#) for more information.
2. Click **Administration** > **Advanced** in the side menu bar.
3. Under the **BYOD** window group, click the **Airplay/Miracast P2P PIN** checkbox. If this checkbox has a check mark in it, then the feature is enabled.
4. Click the **AirPlay/Miracast P2P Pin expiration** drop-down list and select the desired time interval.

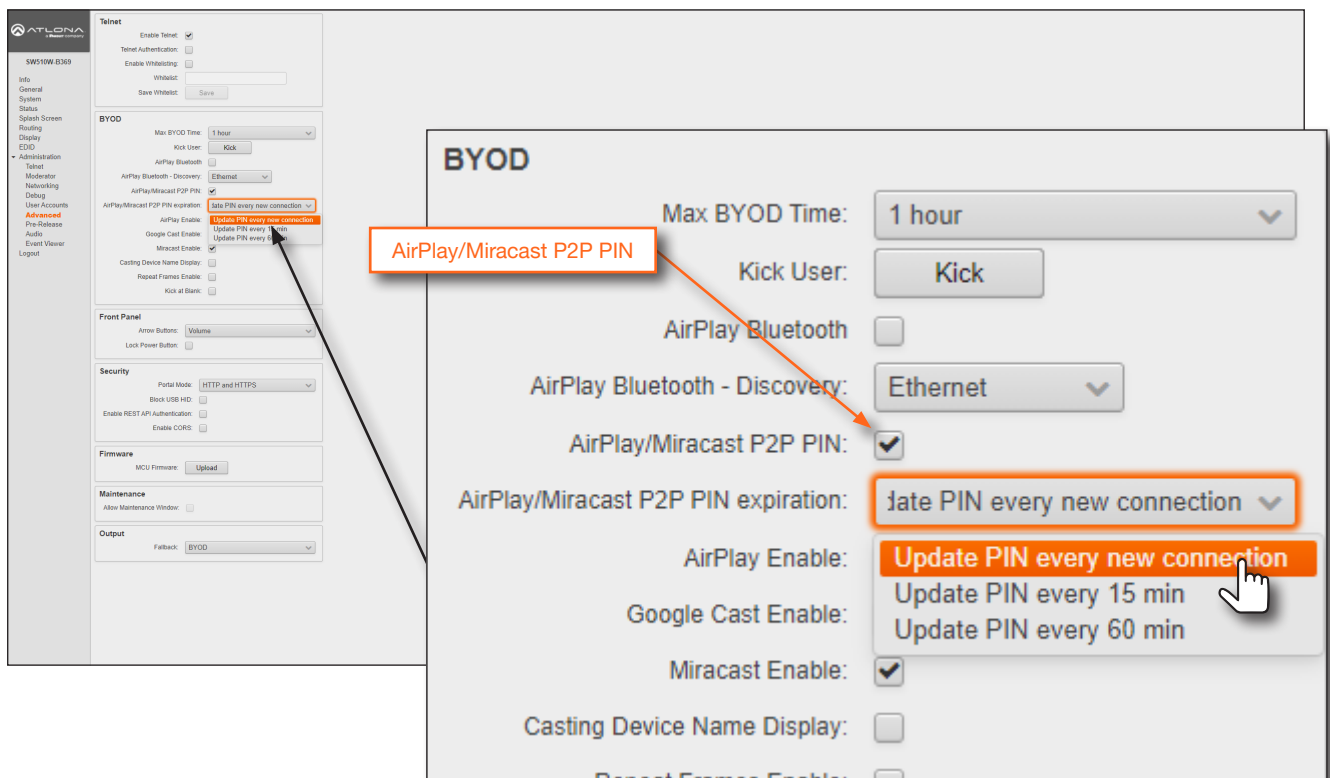

The screenshot shows the ATLONA web interface with the BYOD configuration page. The 'AirPlay/Miracast P2P PIN' checkbox is checked, and the 'AirPlay/Miracast P2P PIN expiration' dropdown is set to 'Update PIN every new connection'. A callout box highlights the 'AirPlay/Miracast P2P PIN' checkbox and the expiration dropdown.

BYOD

Max BYOD Time: 1 hour

Kick User: Kick

AirPlay Bluetooth:

AirPlay Bluetooth - Discovery: Ethernet

AirPlay/Miracast P2P PIN:

AirPlay/Miracast P2P PIN expiration: Update PIN every new connection

AirPlay Enable: Update PIN every new connection

Google Cast Enable: Update PIN every 15 min

Miracast Enable:

Casting Device Name Display:

Repeat Frames Enable:

Moderator Mode

Moderator mode provides a layer of control when multiple clients are casting through the AT-UHD-SW-510W. The “moderator” can either *allow* or *kick* (remove) a client from casting content. Up to four users can be hosted in the **Users** table. However, only one device may cast at a time.



NOTE: In order to monitor which devices are allowed to display content, Moderator mode must be enabled before a device begins casting. If a device is already casting, without Moderator mode enabled, then enabling this feature will have no effect.

1. Login to the web server. Refer to [Logging in to the Web Server \(page 20\)](#) for more information.
2. Set the WiFi mode to either **Access Point** or **Connect to WiFi**. Refer to [Wireless Configuration \(page 41\)](#) for more information.
3. Click **Administration** > **Moderator** in the side menu bar.
4. Under the **Moderator** window group, click the **Enable** checkbox. If this checkbox has a check mark in it, then the feature is enabled.

In order to monitor which devices are allowed to display content, this box must be checked before a device begins casting. If a device is already casting, then enabling this feature will have no effect.

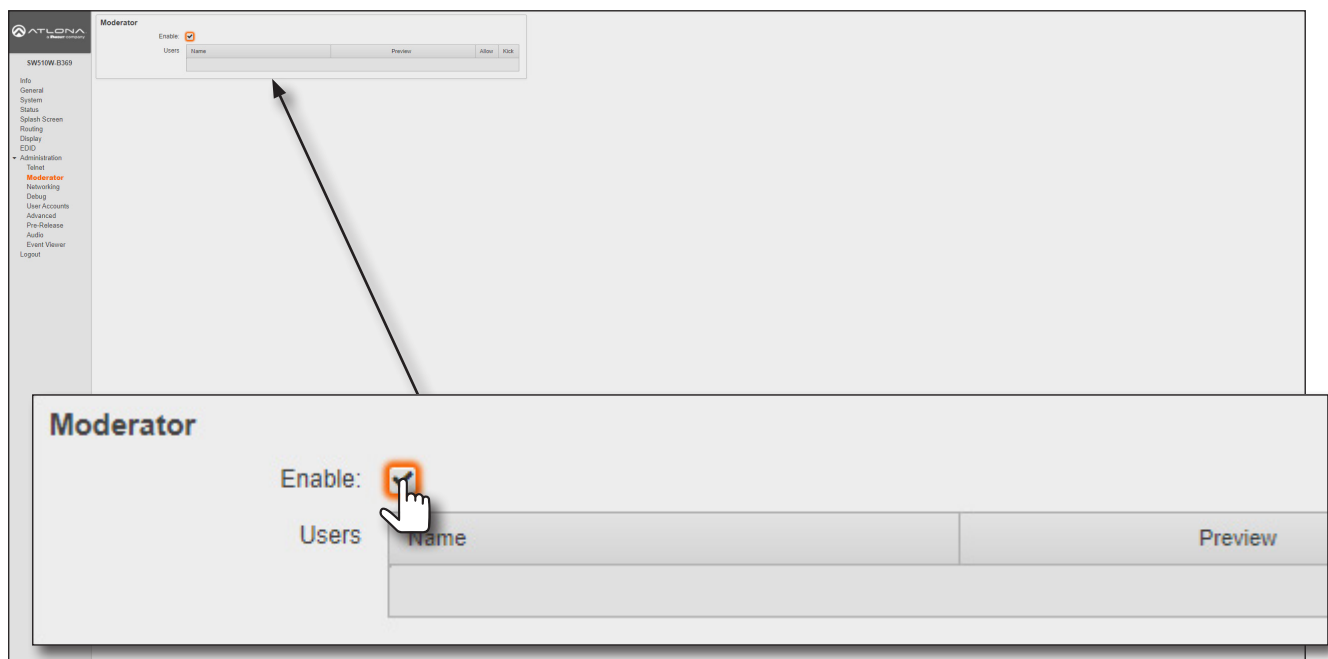

5. Connect the BYOD devices to the AT-UHD-SW-510W. Once connected, the device can begin casting. Refer to [Casting \(page 52\)](#) for more information on how to connect devices for casting.

Once the devices have started casting, they will be displayed in the **Users** table, as shown in the example on the next page. Devices will only appear in this table when they are casting. When devices are displayed in this table, an **Allow** and **Kick** button will also be available for each device.

- Click the **Allow** button to permit a device to begin casting to the display device.

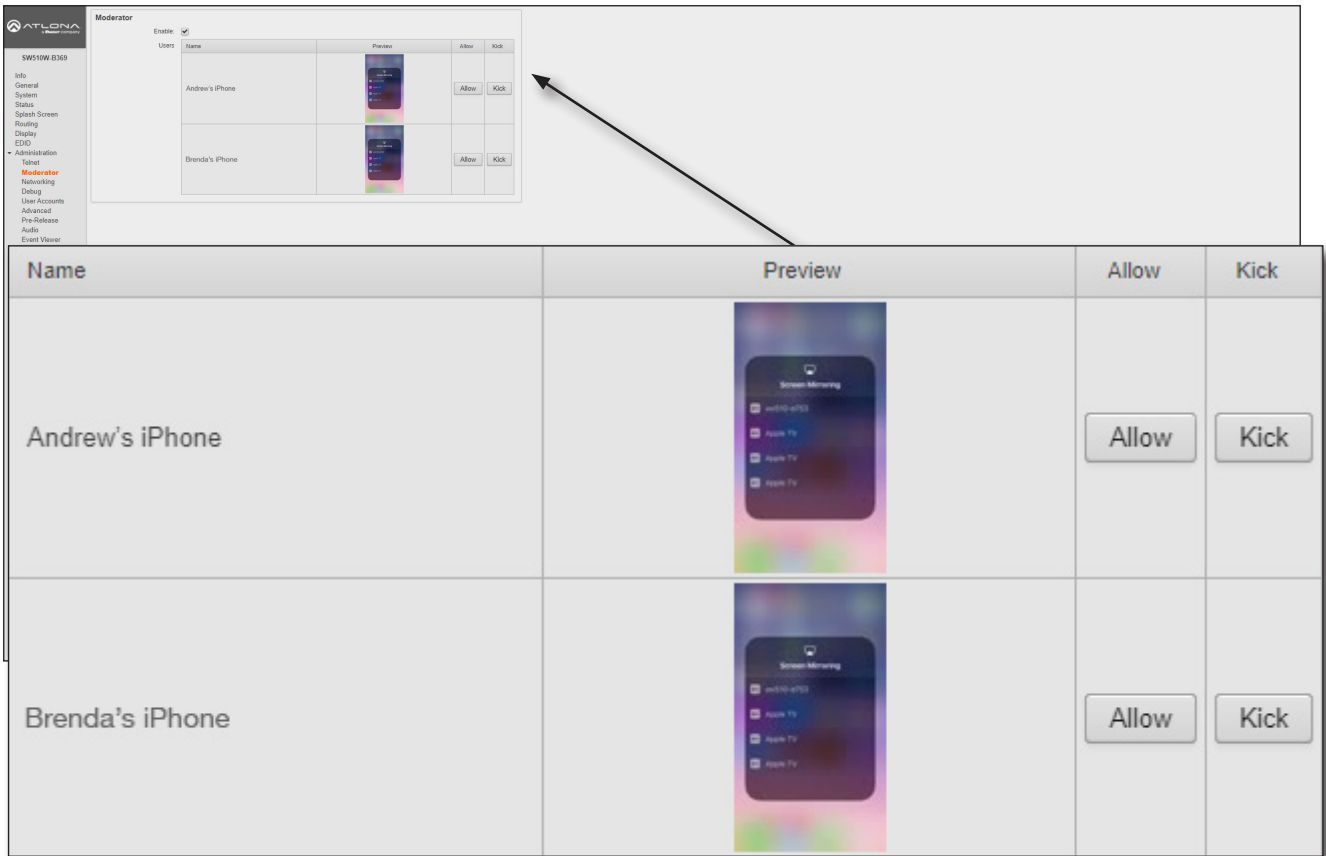

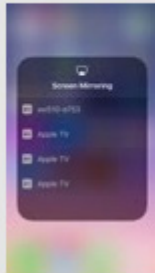
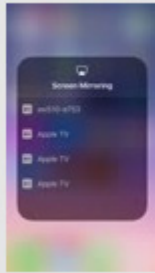

Name	Preview	Allow	Kick
Andrew's iPhone		<input type="button" value="Allow"/>	<input type="button" value="Kick"/>
Brenda's iPhone		<input type="button" value="Allow"/>	<input type="button" value="Kick"/>

Once the selected device is allowed to cast to the connected display device, the **Allow** button will be disabled. In the example below, *Brenda's iPhone* is now the active casting device and shown on the display device.

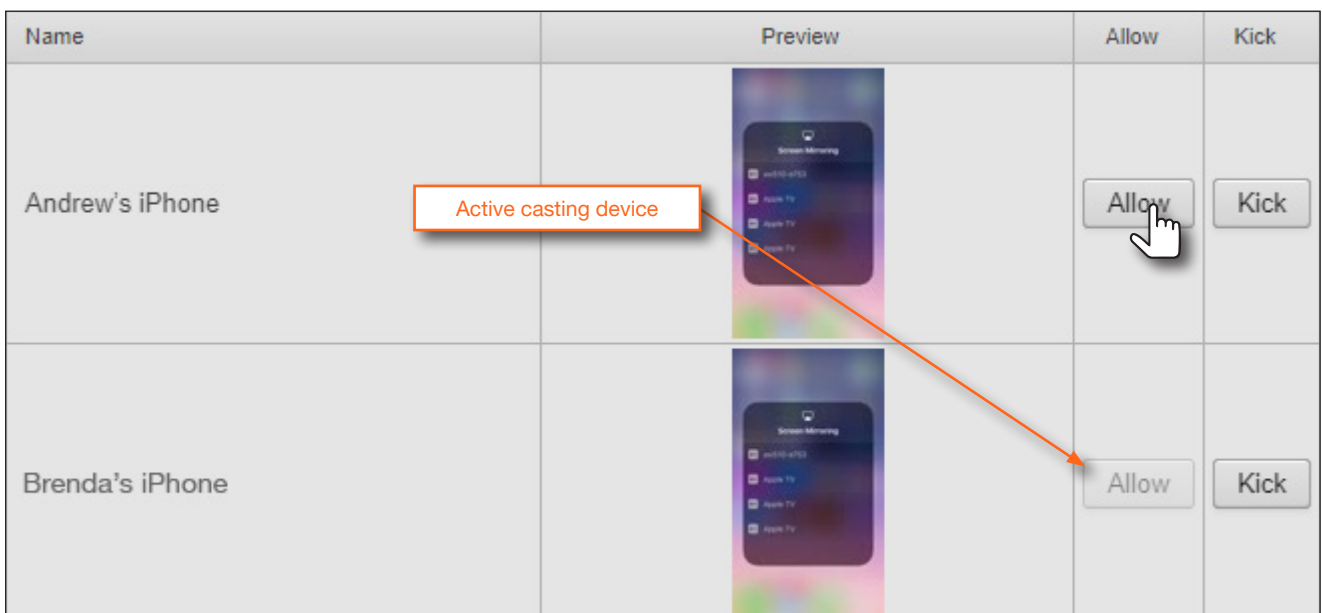

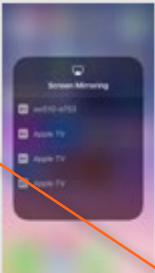
- Click the **Allow** button, next to another device, to make that device the active casting device. Clicking the **Allow** button, allows switching between multiple casting devices that are connected to the AT-UHD-SW-510W. Note that it may take a few moments before the content from the casting device appears on the screen.



Name	Preview	Allow	Kick
Andrew's iPhone		<input type="button" value="Allow"/>	<input type="button" value="Kick"/>
Brenda's iPhone		<input type="button" value="Allow"/>	<input type="button" value="Kick"/>

Device Operation

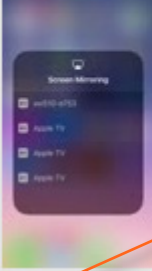
- Click the **Kick** button to explicitly disconnect a casting device from the AT-UHD-SW-510W. Any casting device can be “kicked”, even if it is the active casting device.

Name	Preview	Allow	Kick
Andrew's iPhone		Allow	Kick 
Brenda's iPhone		Allow	Kick

Note: An orange box labeled "Active casting device" points to the Preview column of Brenda's iPhone row.

Once a device has been “kicked”, it will no longer appear in the **Users** table. In the example below, the device *Andrew's iPhone* has been removed from the **Users** table.

- To reconnect a device that has been “kicked”, select the hostname of the AT-UHD-SW-510W from the cast menu of the BYOD device. After a successful connection, the device will appear in the **Users** table.

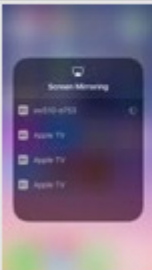
Name	Preview	Allow	Kick
Brenda's iPhone		Allow	Kick

Display Control Methods

The AT-UHD-SW-510W provides various methods for display control. The following section describes and provides instructions for each method. By default, the AT-UHD-SW-510W uses CEC commands to control the display.

Active Video Presence

This method will instruct the AT-UHD-SW-510W to toggle power on the display, based on the absence/presence of either a video signal on any of the physical inputs or a casting device. The **Auto Power Off Timer** interval must expire before the display is turned off. **AutoSwitch** must also be enabled for this method to work.

1. Login to the web server. Refer to [Logging in to the Web Server \(page 20\)](#) for more information.
2. Click **Display** in the side menu bar.
3. Under the **Control** window group, make sure that the **AutoSwitch** checkbox is checked. This feature must be enabled.
4. Click the **Display Control Method** drop-down list and select **Active Video Presence**.

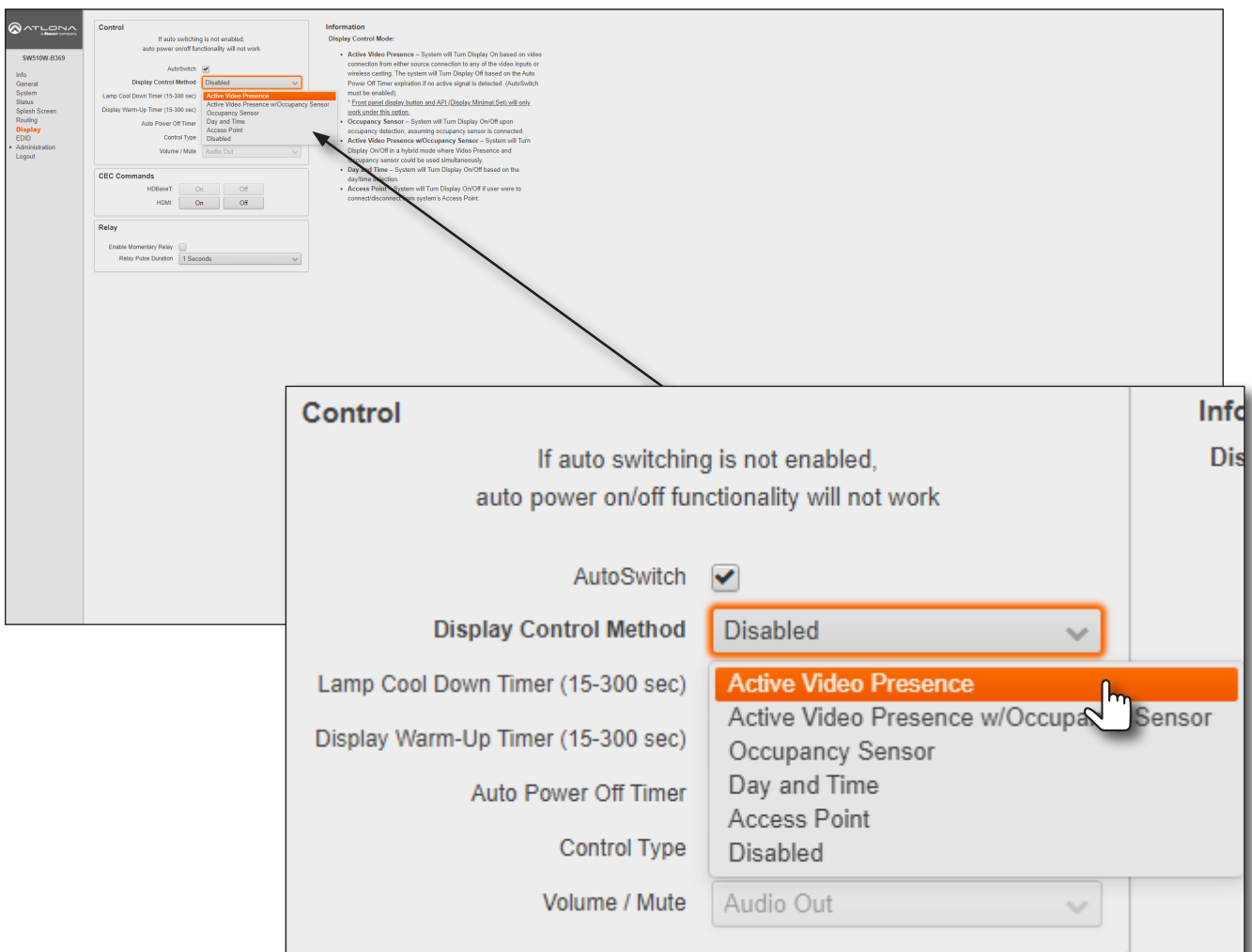

- Click the **Auto Power Off Timer** drop-down list and select the desired time interval. This is the amount of time that must elapse, before the display is turned off.

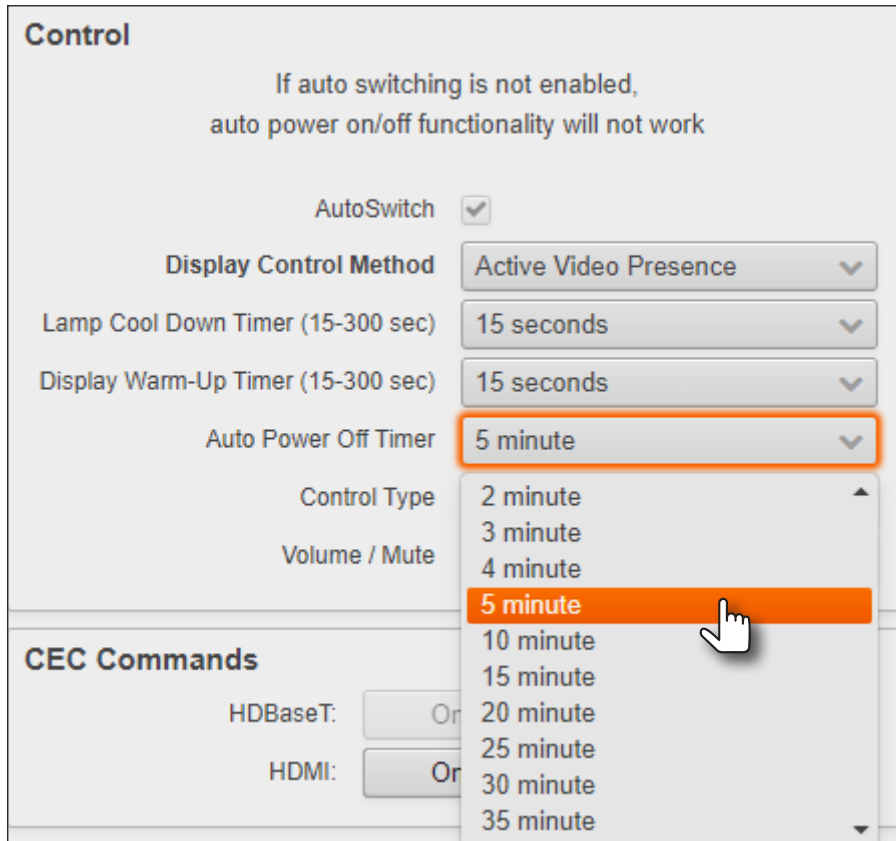

Control

If auto switching is not enabled,
auto power on/off functionality will not work

AutoSwitch

Display Control Method Active Video Presence ▾

Lamp Cool Down Timer (15-300 sec) 15 seconds ▾

Display Warm-Up Timer (15-300 sec) 15 seconds ▾

Auto Power Off Timer 5 minute ▾

Control Type 2 minute
3 minute
4 minute
5 minute
10 minute
15 minute
20 minute
25 minute
30 minute
35 minute

Volume / Mute

CEC Commands

HDBaseT: On

HDMI: On

- Setup is complete.

Active Video Presence with Occupancy Sensor

This method is similar to the **Active Video Presence** mode, except that an occupancy sensor can also be used to provide hybrid operation. If using this mode, an occupancy sensor should be connected to the **TRIGGER I/O** port on the AT-UHD-SW-510W. Refer to [Trigger I/O \(page 11\)](#) for wiring information.

1. Login to the web server. Refer to [Logging in to the Web Server \(page 20\)](#) for more information.
2. Click **Display** in the side menu bar.
3. Under the **Control** window group, make sure that the **AutoSwitch** checkbox is checked. This feature must be enabled.
4. Click the **Display Control Method** drop-down list and select **Active Video Presence w/Occupancy Sensor**.

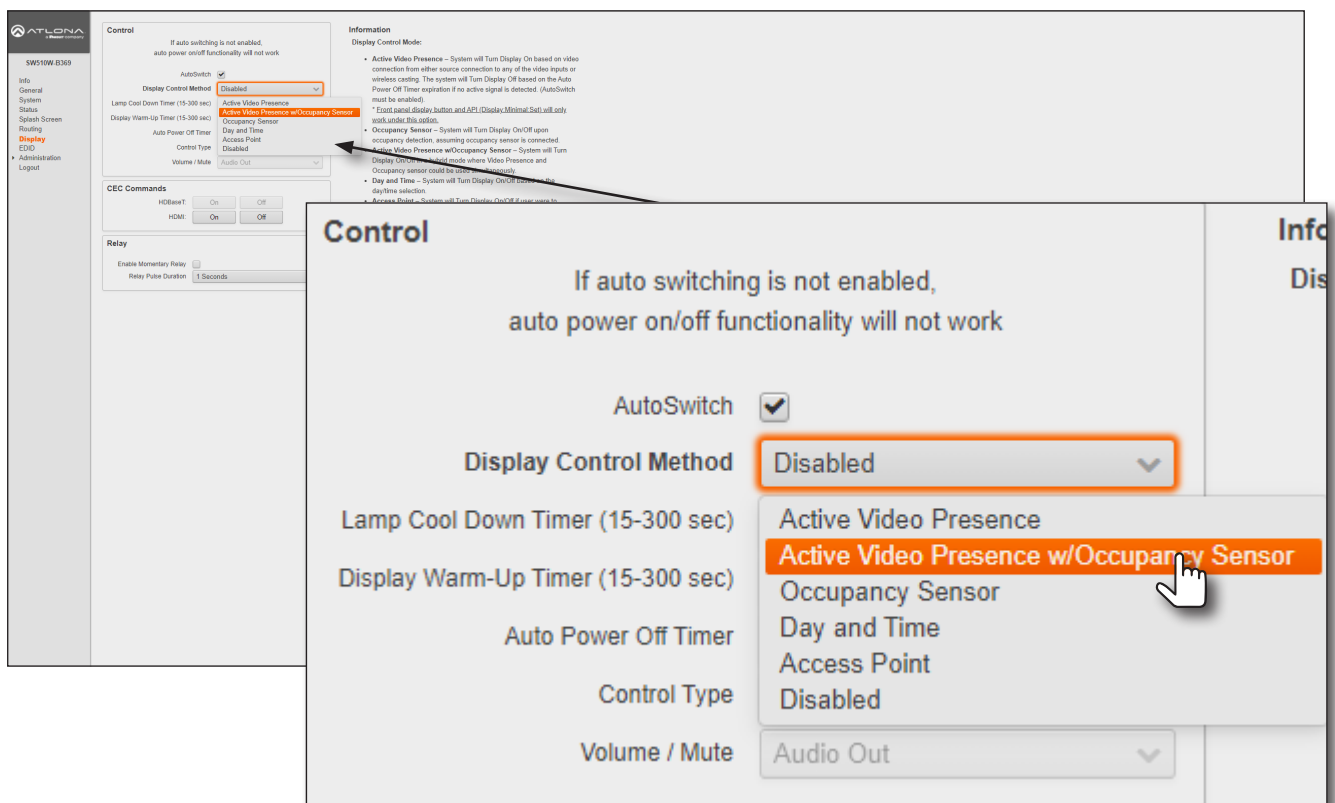

5. The **Trigger I/O** window group will be displayed, along with two checkboxes: **Enable Trigger On** and **Enable Trigger Off**.

Check the **Enable Trigger On** checkbox to enable a *power-on* state when the trigger voltage is pulled from low to high. Check the **Enable Trigger Off** checkbox to enable a *power-off* state when the trigger voltage is pulled from low to high. Either or both checkboxes can be enabled. When enabled, all other display power options are overridden.



6. Setup is complete.

Occupancy Sensor

The following provides instructions on adding the AT-OCS-900N occupancy sensor as a device. **AutoSwitch** does not need to be enabled for this feature to work.



IMPORTANT: A username and password must be configured on the AT-OCS-900N before using the device with the AT-UHD-SW510W.

1. Connect the AT-OCS-900N to the network. Refer to the AT-OCS-900N User Manual for more information.
2. Login to the web server of the AT-UHD-SW-510W. Refer to [Logging in to the Web Server \(page 20\)](#) for more information.
3. Click **Display** in the side menu bar.
4. Click the **Display Control Method** drop-down list and select **Occupancy Sensor**.

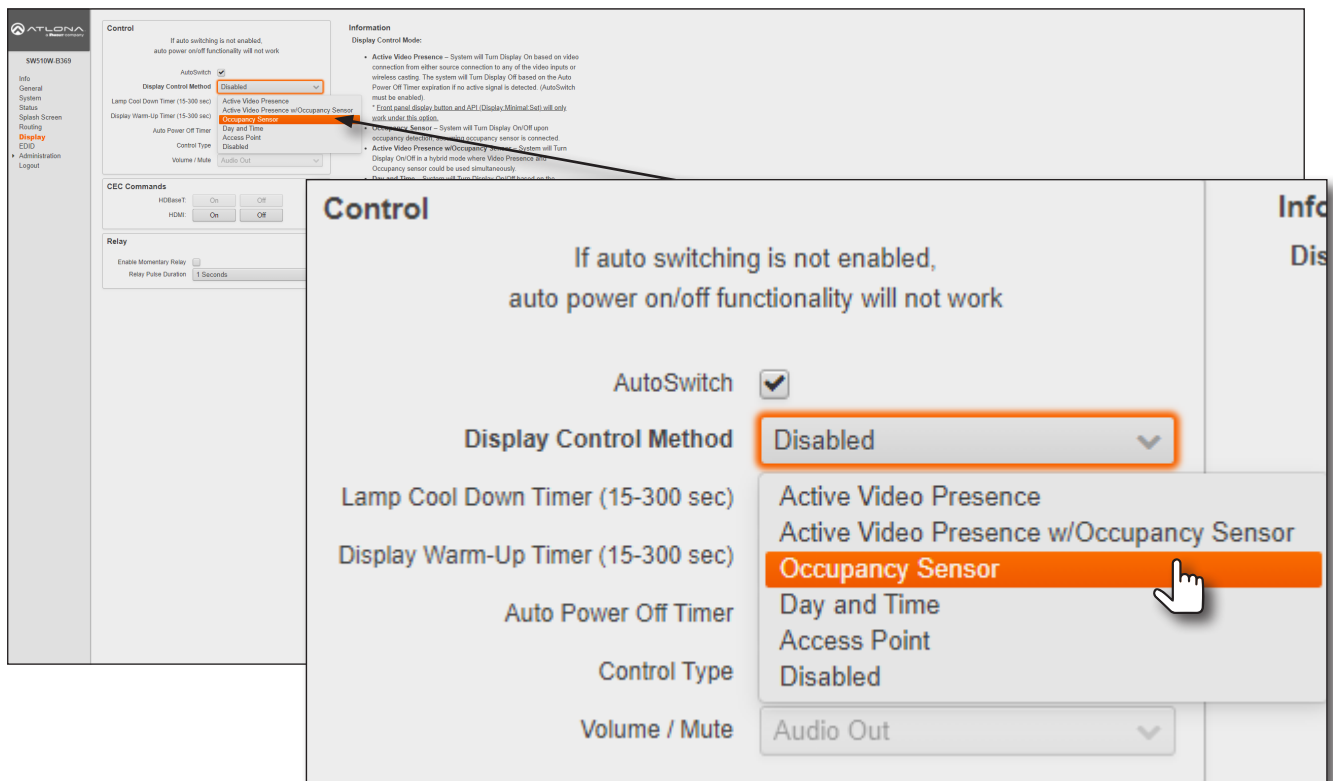

The screenshot shows the 'Control' section of the web interface. A warning message states: "If auto switching is not enabled, auto power on/off functionality will not work". The 'AutoSwitch' checkbox is checked. The 'Display Control Method' dropdown menu is open, showing options: 'Disabled', 'Active Video Presence', 'Active Video Presence w/Occupancy Sensor', 'Occupancy Sensor' (highlighted), 'Day and Time', 'Access Point', and 'Disabled'. The 'Volume / Mute' dropdown is set to 'Audio Out'.

5. The **Occupancy Sensor Control** window group will be displayed, as shown:

Occupancy Sensor Control

Turn Display On on Occupancy

Turn Display Off on Vacancy

IP

Port

Sensors

Status	IP		

Device Operation

6. Click the **Turn Display On on Occupancy** checkbox to enable or disable this feature. When enabled, a checkmark will appear in the checkbox and the occupancy sensor will power-on the display when the room is occupied.
7. Click the **Turn Display Off on Vacancy** checkbox to enable or disable this feature. When enabled, a checkmark will appear in the checkbox and the occupancy sensor will power-off the display when the room is no longer occupied.
8. Enter the IP address of the occupancy sensor in the **IP** field.
9. Enter the port number in the **Port** field. The default port setting is 9000.



IMPORTANT: When adding an occupancy sensor, it is recommended that a static IP address is assigned to the occupancy sensor. DHCP is not recommended.

10. Click the **Connect** button to connect to the occupancy sensor. All connected occupancy sensors will appear under the **Sensors** section, as shown below.
11. Click the **Identify** button to identify the occupancy sensor. This feature is useful when multiple sensors are connected. See *Example A* below.



NOTE: The AT-UHD-SW-510W supports a maximum of three AT-OCS-900N devices.

12. Click the **Remove** button to delete a sensor from the **Sensors** list.
13. Setup is complete.

Occupancy Sensor Control

Turn Display On on Occupancy

Turn Display Off on Vacancy

IP

Port

Sensors

Status	IP		
Connected!	10.1.0.24:9000	<input type="button" value="Identify"/>	<input type="button" value="Remove"/>

Example A - Multiple occupancy sensors added to the AT-UHD-SW-510W.

Sensors

Status	IP		
Connected!	10.1.0.25:9000	<input type="button" value="Identify"/>	<input type="button" value="Remove"/>
Connected!	10.1.0.24:9000	<input type="button" value="Identify"/>	<input type="button" value="Remove"/>

Day and Time

This method allows manual setup of day and time to determine when the display device will be power-on and powered-off. **AutoSwitch** does not need to be enabled for this feature to work.

1. Login to the web server. Refer to [Logging in to the Web Server](#) (page 20) for more information.
2. Click **Display** in the side menu bar.
3. Click the **Display Control Method** drop-down list and select **Day and Time**.

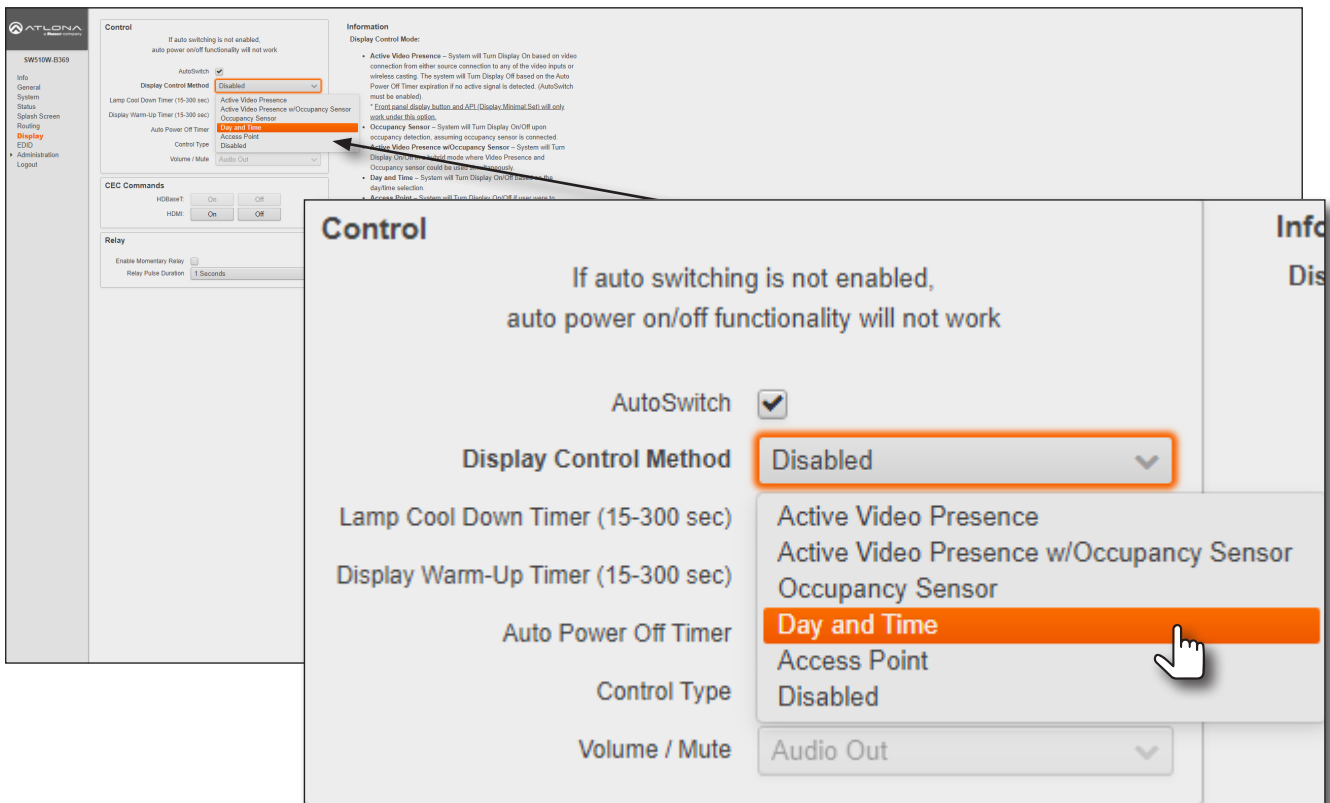

4. The **Time Display Control** window group will be displayed.
5. Click the **Start Time** drop-down lists to select the time when the display should be powered-on.
6. Click the **End Time** drop-down lists to select the display power-off time.
7. Click the **Timezone** drop-down list to select the correct time zone.
8. Click the desired checkboxes to select which days to apply the schedule.
9. Setup is complete.

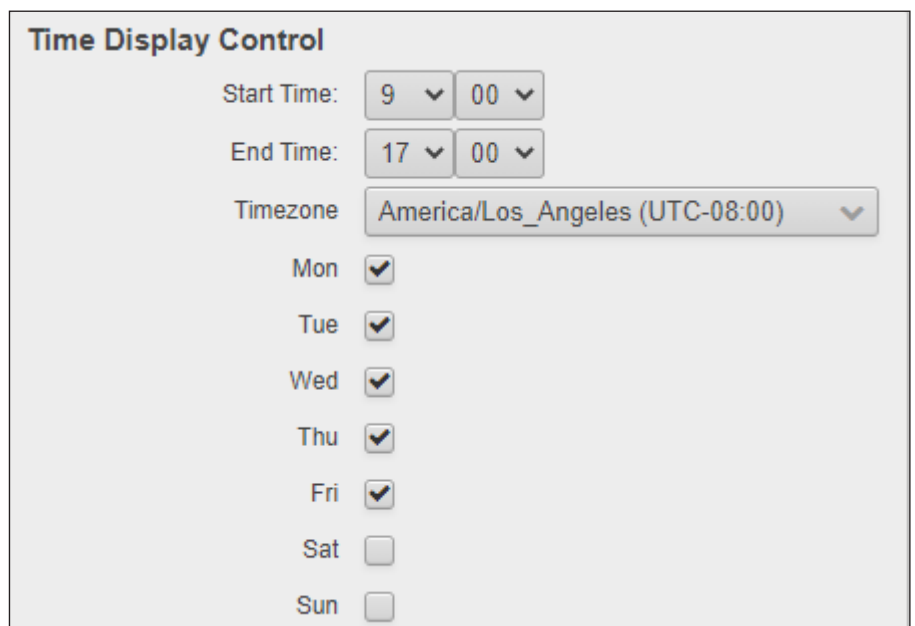

Access Point

This method uses the presence or absence of a wireless connection to determine the power state of the system. In order for this feature to work, the AT-UHD-SW-510W must be set as an Access Point. Refer to [Access Point Mode \(page 41\)](#) for more information.

1. Login to the web server. Refer to [Logging in to the Web Server \(page 20\)](#) for more information.
2. Click **Display** in the side menu bar.
3. Click the **Display Control Method** drop-down list and select **Access Point**.

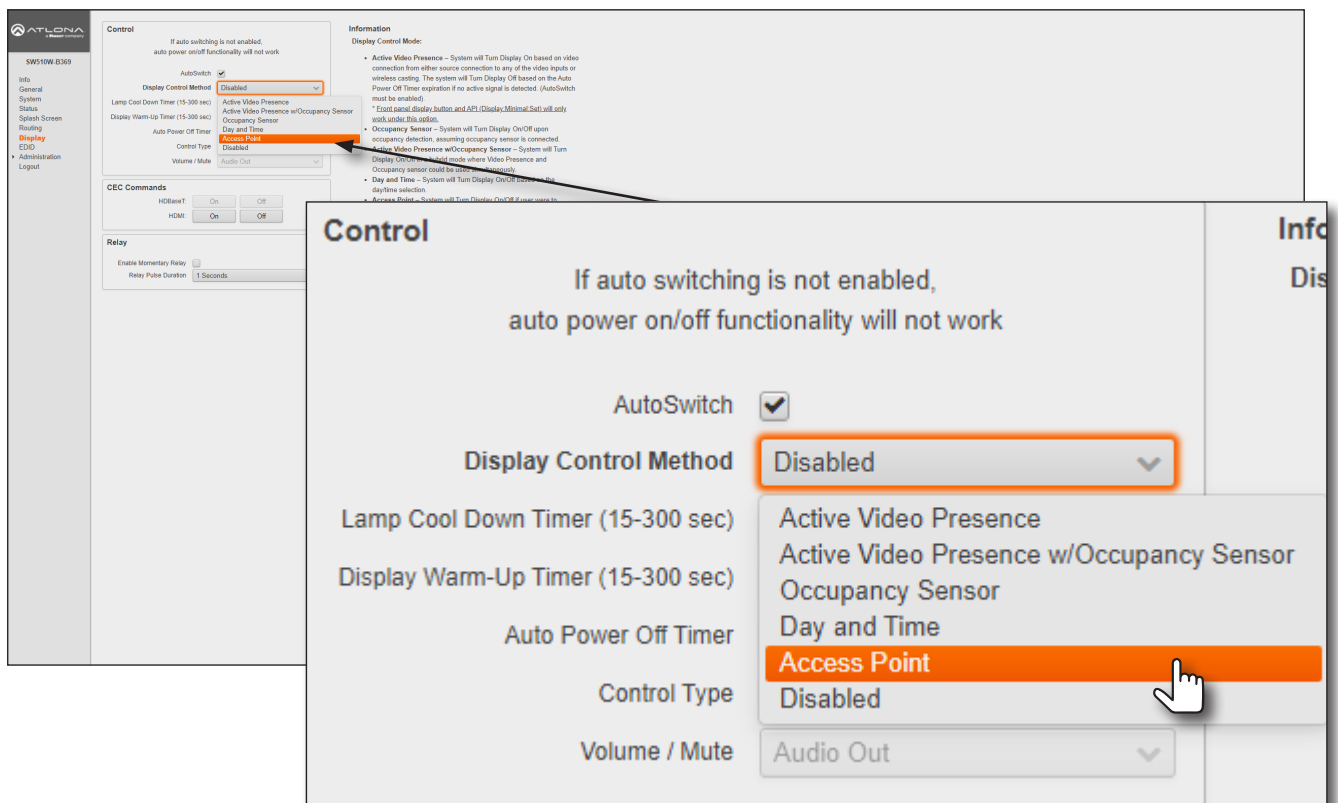

4. Setup is complete.

Changing the Password

1. Login to the web server. Refer to [Logging in to the Web Server \(page 20\)](#) for more information.
2. Click **Administration > User Accounts** in the side menu bar.
3. Under the **User Accounts** window group, click the **Change** button.

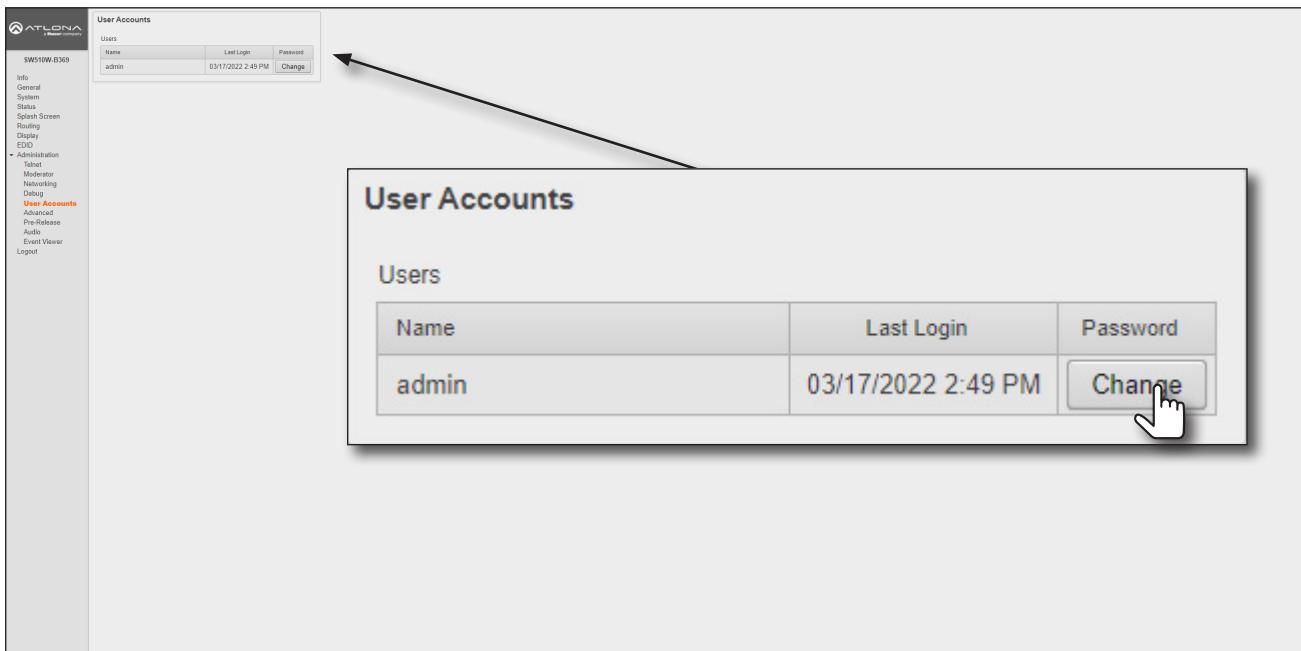

4. The **Change Password: admin** dialog box will be displayed. Enter the new password in the **Password** field. Make sure to delete all the asterisks (masks) in this field before entering the new password.
5. To confirm the password, enter the same password in the **Repeat Password** field. Make sure to delete all the asterisks (masks) in this field before entering the new password.
6. Click the **Save** button to commit changes.



The dialog box is titled 'Change Password: admin' and contains the text 'Change the password for: admin'. It features two input fields: 'Password:' and 'Repeat Password:', both containing masked characters (asterisks). At the bottom, there are 'Save' and 'Cancel' buttons.

Configuration and Management Interfaces

Web Server

The AT-UHD-SW-510W includes a built-in web server. Atlona recommends that the web server be used to set up the AT-UHD-SW-510W, as it provides intuitive management of all features. Refer to [Logging in to the Web Server \(page 20\)](#) for more information.

Login Register page

This page is displayed when the AT-UHD-SW-510W web server is launched for the first time.

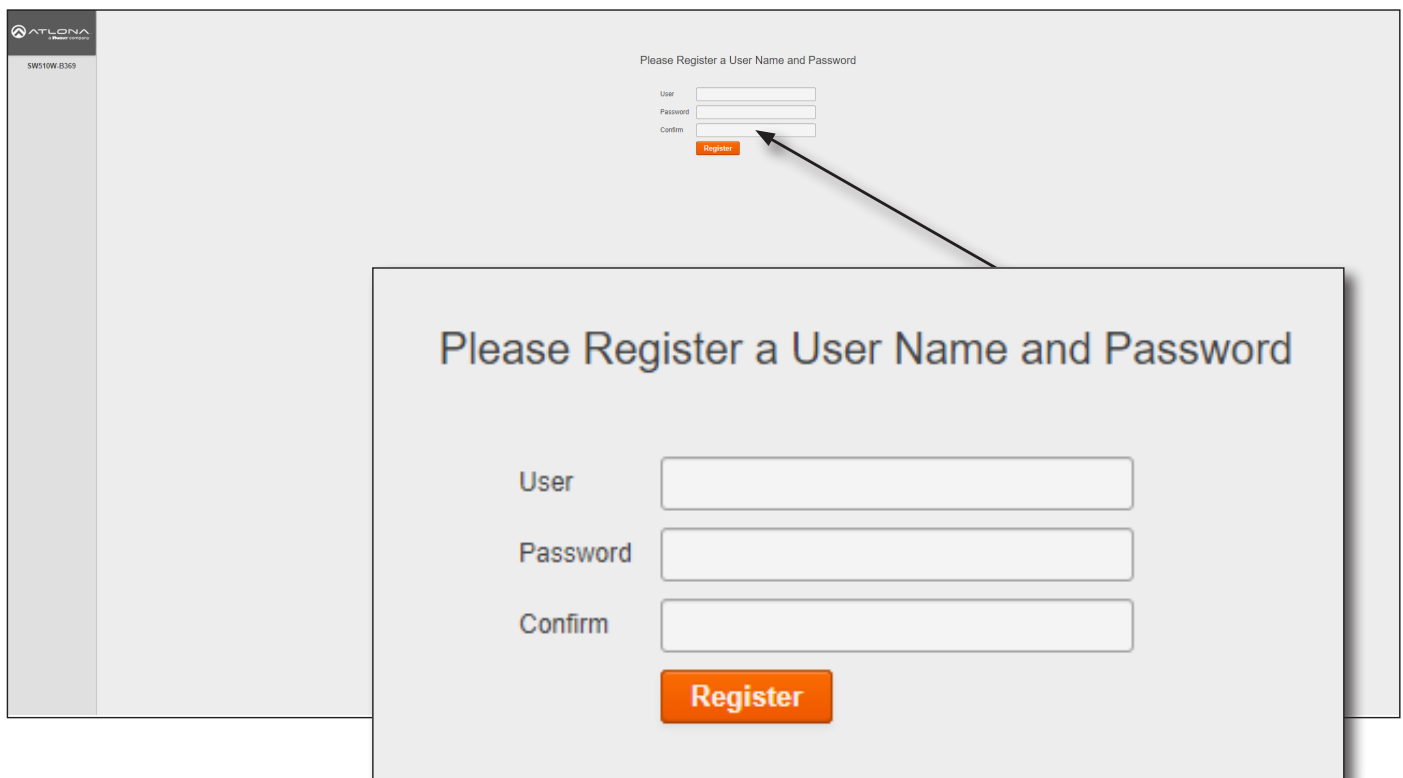

The screenshot shows the registration page for the AT-UHD-SW-510W web server. The page has a header with the Atlona logo and the model number SW510W-B369. The main content area is titled "Please Register a User Name and Password" and contains three input fields labeled "User", "Password", and "Confirm", followed by an orange "Register" button. A callout box provides a larger view of the registration form, showing the title "Please Register a User Name and Password" and the three input fields and "Register" button.

User

Enter the desired username in this field.

Password

Enter the desired password in this field.

Confirm

Re-enter the desired password in this field.

Register

Click this button to register the username and password with the AT-UHD-SW-510W.

Configuration and Management Interfaces

Login page

This page is displayed when the IP address of the AT-UHD-SW-510W is entered in the address bar of a web browser.

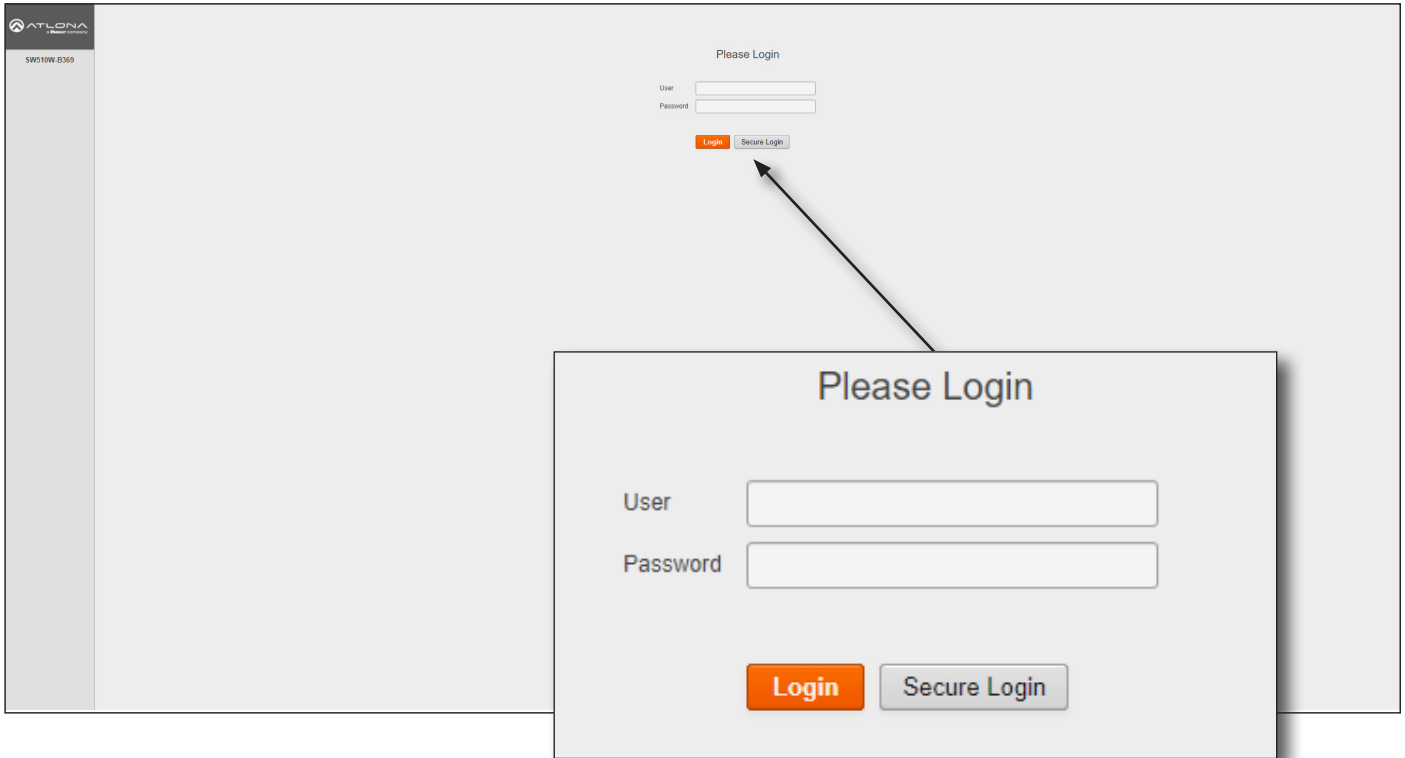

User

Enter the username in this field.

Password

Enter the password in this field.

Login

Click this button to login.

Secure Login

Click this button to login, if a secure connection is being used.

Configuration and Management Interfaces

Info page

After logging in, the Info page will be displayed. The **Info** page provides basic information about the receiver, including the model name, software version, input video timing, and the device being using as the transmitter.

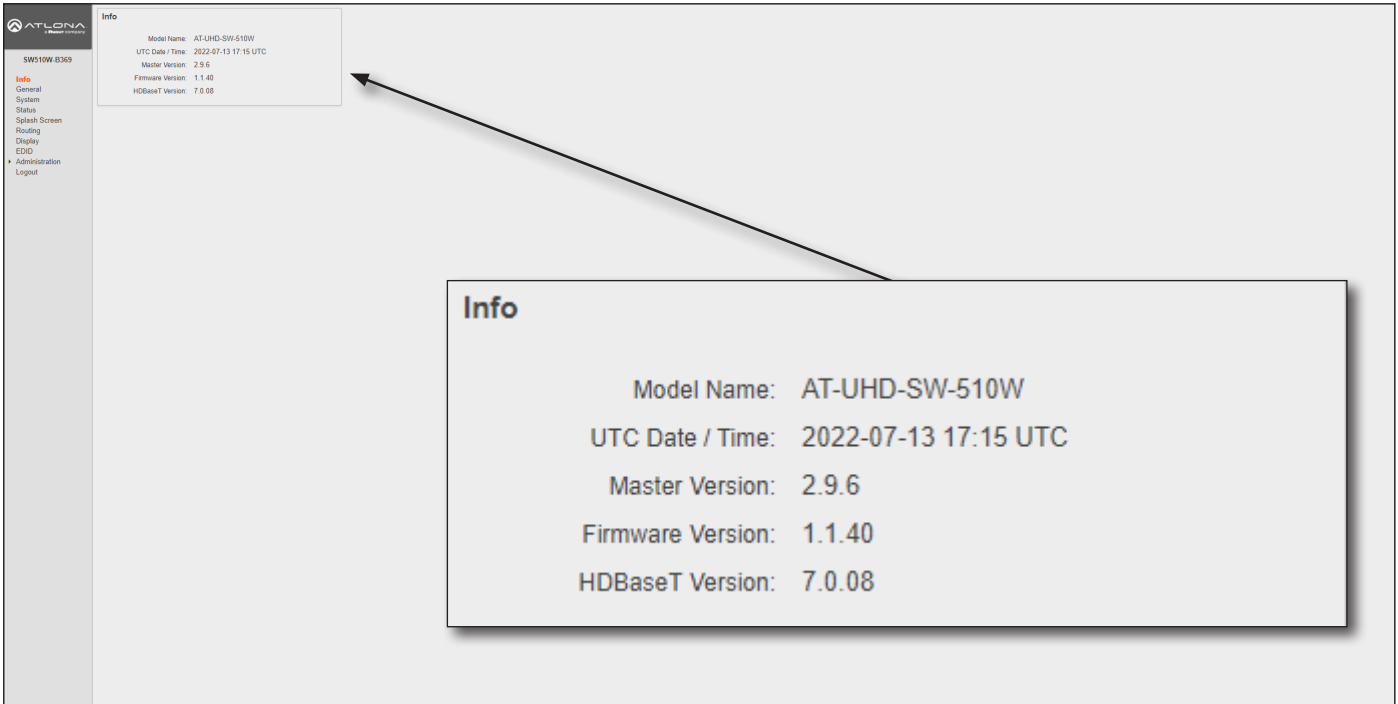

Info

Model Name

The model SKU of this product.

UTC Date / Time

The current time and date, in Universal Coordinated Time (UTC).

Master Version

The version of firmware.

Firmware Version

The version of firmware that the AT-UHD-SW-510W is running. Always make sure to check the AT-UHD-SW-510W product page, on the Atlona web site, for the latest version of firmware.

HDBaseT Version

The HDBaseT version of firmware that the AT-UHD-SW-510W is running.



NOTE: When the local time has not been set, the warning message (shown above) will be displayed in the **Info** window group. The local time must be set before maintenance mode can be enabled. Refer to [Setting the System Date and Time \(page 22\)](#) for more information on setting the local time.

Configuration and Management Interfaces

General page

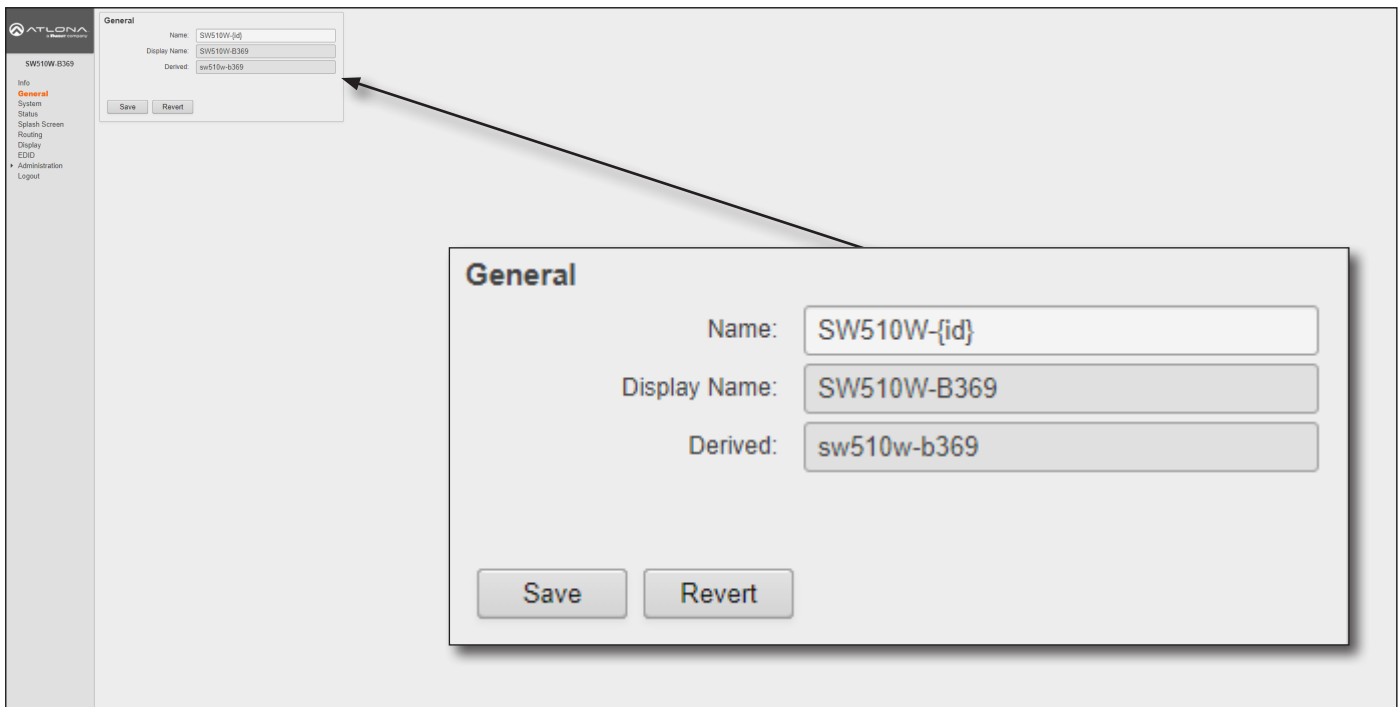

The screenshot shows the ATLONA configuration interface. On the left is a sidebar with a navigation menu: Info, General, System, Status, Splash Screen, Routing, Display, EDID, Administration, and Logout. The main content area is titled 'General' and contains three text input fields: 'Name' with the value 'SW510W-{id}', 'Display Name' with the value 'SW510W-B369', and 'Derived' with the value 'sw510w-b369'. Below these fields are 'Save' and 'Revert' buttons. A callout box on the right provides a larger view of the 'General' form, showing the same fields and buttons.

General

Name

This is the hostname of the unit. Enter the desired name of the AT-UHD-SW-510W in this text field. Include the {id} tag to use the last four digits of the hardware MAC address. Hostnames can contain alphabetic and numeric characters.



NOTE: The hardware MAC address differs from the MAC address of the unit, which is found on an adhesive label applied to the the bottom of the unit.

Display Name

The name based on the information provided in the **Name** field. This name is used by the AT-UHD-SW-510W to identify it within the OSD.

Derived

This field will automatically be populated by the AT-UHD-SW-510W, based on the information provided in the **Name** field. This field provides a “computer-friendly” name used by the SSID. If special characters and/or spaces are included in the **Name** field, then these are removed when populating this field.

Save

Click this button to accept all changes.

Revert

Click this button to abort changes and reset the previous text in the **Name** field.

Configuration and Management Interfaces

System page

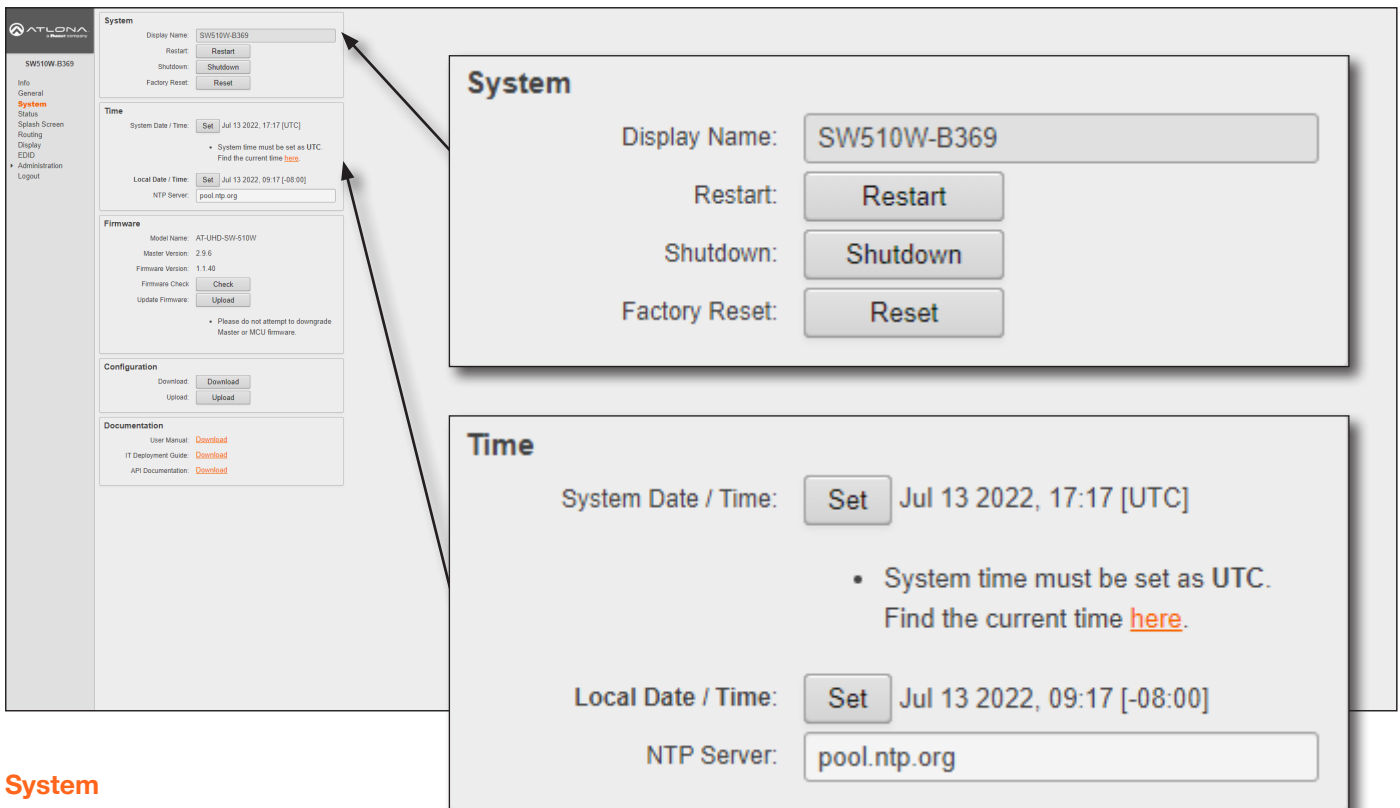

System

Display name

This field serves as the SSID, when connecting wirelessly to the AT-UHD-SW-510W. This name can be changed in the **Name** field of the **General** tab. Refer to [General page \(page 76\)](#) for more information.

Restart

Click this button to reboot the AT-UHD-SW-510W.

Shutdown

Click this button to shut down the AT-UHD-SW-510W. This should always be performed before disconnecting power from the unit.

Factory Reset

Click the **Reset** button to reset the AT-UHD-SW-510W to factory-default settings. Resetting to factory-default setting may take up to five minutes to complete. Refer to [Resetting to Factory-Default Settings \(page 18\)](#) for more information.

Time

Set (System Date / Time)

Click this button to set the month, day, and time (in UTC).

Set (Local Date / Time)

Click this button to set the local date and time using the NTP server specified in the **NTP Server** field.

NTP Server

Enter the desired NTP server in this field.

Configuration and Management Interfaces

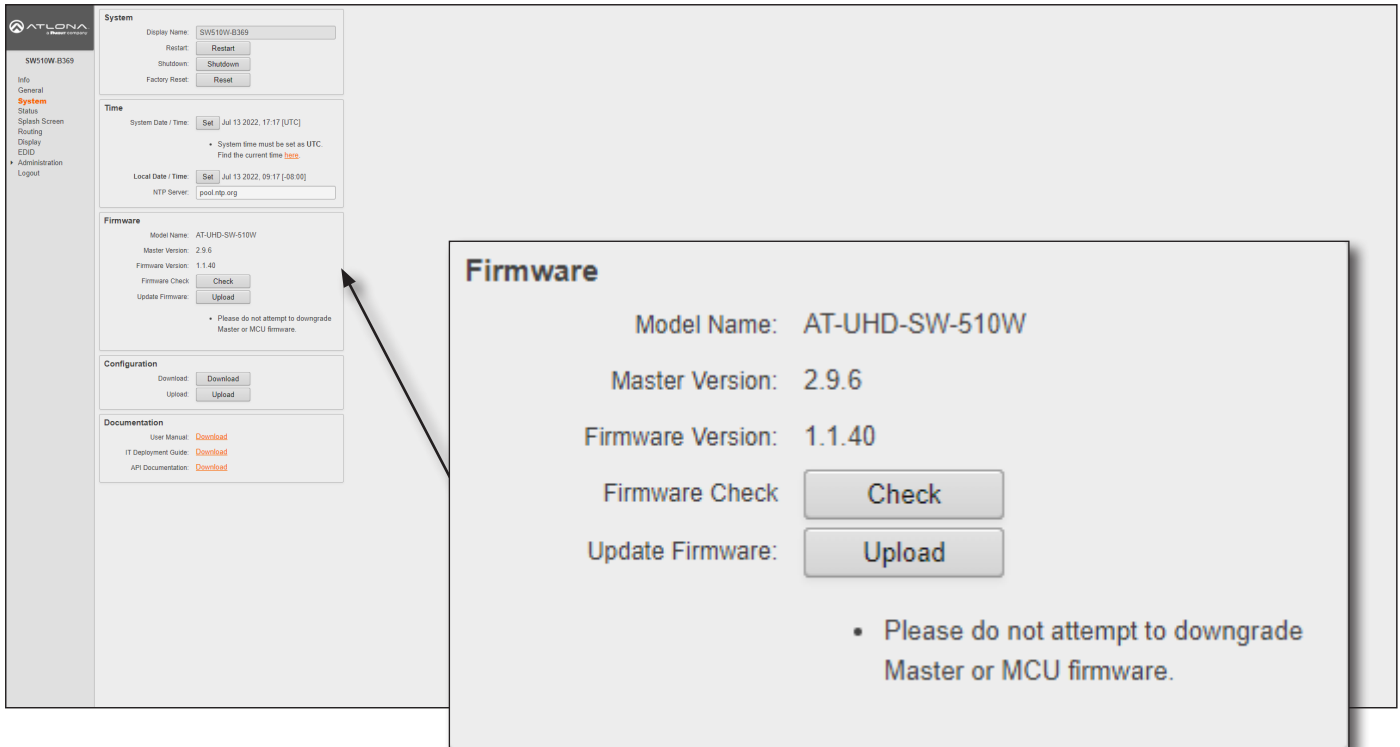

Firmware

Model Name

The SKU of the product: AT-UHD-SW-510W.

Master Version

The master version of firmware. Always make sure to check the AT-UHD-SW-510W product page, on the Atlona web site, for the latest version of firmware.

Download

Click this link to download the latest firmware. The most recent firmware version is listed.

Firmware Version

The version of (MCU) firmware that the AT-UHD-SW-510W is running. Always make sure to check the AT-UHD-SW-510W product page, on the Atlona web site, for the latest version of firmware.

Firmware Check

Click the **Check** button to check for the latest version of firmware. Each time the unit is rebooted, this feature is performed, automatically. The AT-UHD-SW-510W must be connected to the Internet to use this feature.

Update Firmware

Click the **Upload** button to upload the firmware file to the AT-UHD-SW-510W. Refer to [Updating the Firmware \(page 110\)](#) for more information.

Configuration and Management Interfaces

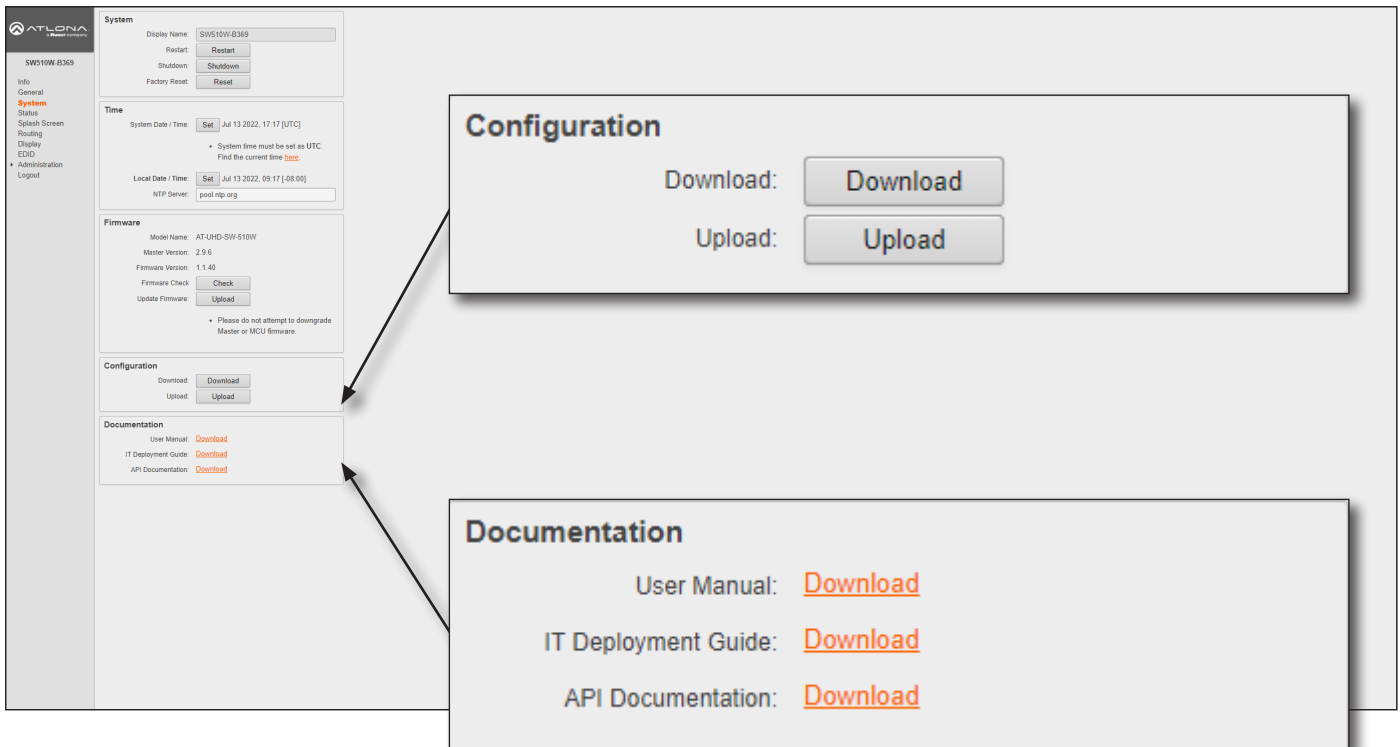

The screenshot shows the web interface for the AT-UID-SW-510W device. The left sidebar contains navigation links: Info, General, System, Status, Splash Screen, Routing, Display, EDID, Administration, and Logout. The main content area is divided into several sections:

- System:** Display Name: SW510W-E369. Buttons: Restart, Shutdown, Factory Reset: Reset.
- Time:** System Date / Time: Sat Jul 13 2022, 17:17 [UTC]. Note: System time must be set on UTC. Find the current time [here](#). Local Date / Time: Sat Jul 13 2022, 09:17 [-08:00]. NTP Server: pool.ntp.org.
- Firmware:** Model Name: AT-UHD-SW-510W. Master Version: 2.9.6. Firmware Version: 1.1.40. Buttons: Check, Update Firmware. Note: Please do not attempt to downgrade Master or MCU firmware.
- Configuration:** Buttons: Download, Upload.
- Documentation:** User Manual: [Download](#). IT Deployment Guide: [Download](#). API Documentation: [Download](#).

Two callout boxes are overlaid on the interface:

- Configuration:** Contains buttons for Download and Upload.
- Documentation:** Contains links for User Manual: [Download](#), IT Deployment Guide: [Download](#), and API Documentation: [Download](#).

Configuration

Download

Click this button to download the current AT-UHD-SW-510W configuration to a .zip file. The default filename is `config.zip`. Within the `config.zip` is the `configuration.zip` file. Note that the information within the `configuration.zip` file cannot be extracted as it is only readable by the AT-UHD-SW-510W.

Upload

Click this button to upload the configuration file to the AT-UHD-SW-510W. Both the **Download** and **Upload** button are useful to save and load different configurations and/or to provide a backup, in the unlikely event of a system failure.

Documentation

User Manual

Click the **Download** link to view the latest version of the User Manual.

IT Deployment Guide

Click the **Download** link to view the IT Deployment Guide.

API Documentation

Click the **Download** link to view the latest API documentation.

Configuration and Management Interfaces

Status page

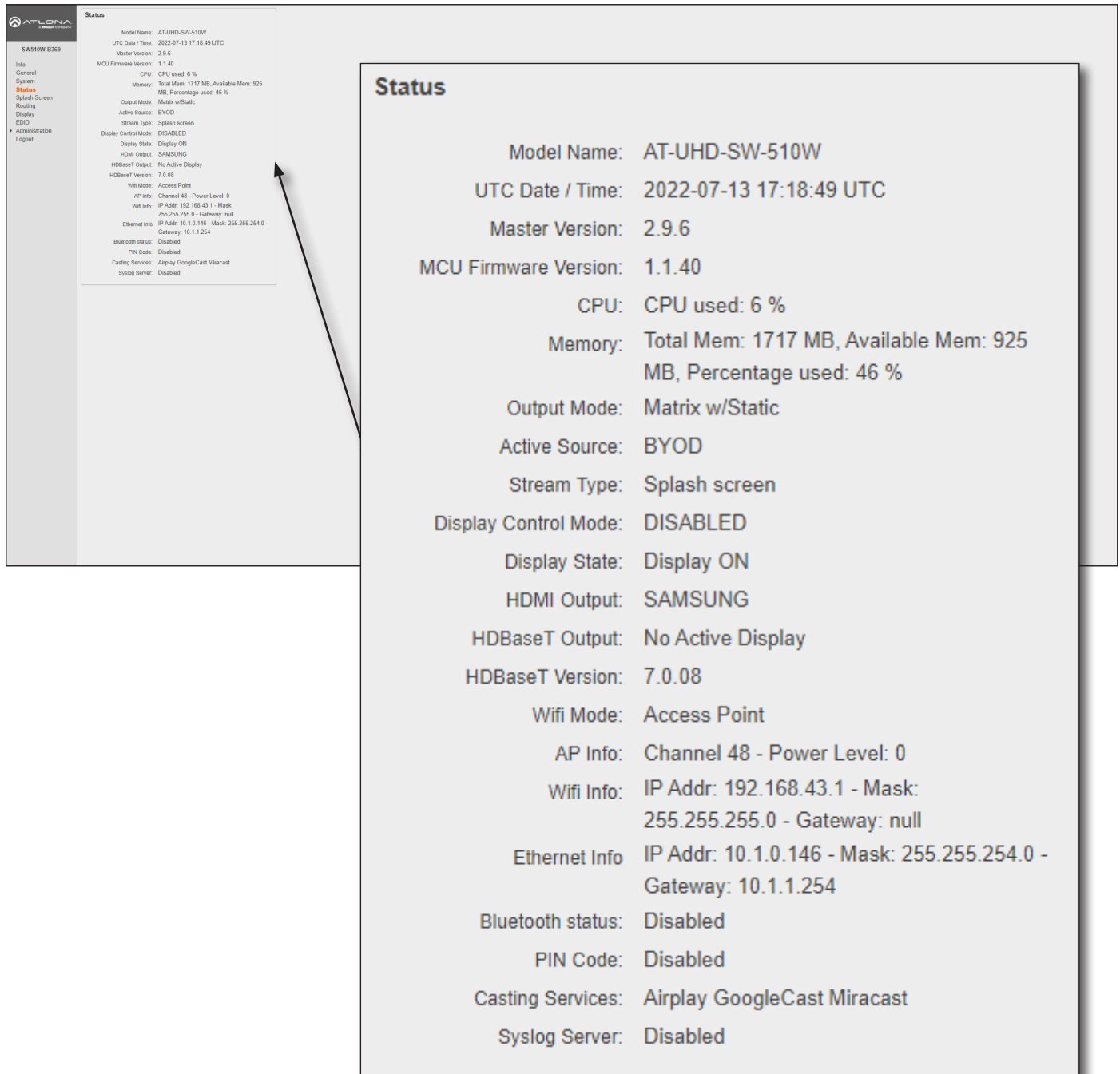

ATLONA
a PANOUT company

SW510W-E369

- Info
- General
- System
- Status**
- Splash Screen
- Routing
- Display
- EDID
- Administration
- Logout

Status

Model Name: AT-UHD-SW-510W
 UTC Date / Time: 2022-07-13 17:18:49 UTC
 Master Version: 2.9.6
 MCU Firmware Version: 1.1.40
 CPU: CPU used: 6 %
 Memory: Total Mem: 1717 MB, Available Mem: 925 MB, Percentage used: 46 %
 Output Mode: Matrix w/Static
 Active Source: BYOD
 Stream Type: Splash screen
 Display Control Mode: DISABLED
 Display State: Display ON
 HDMI Output: SAMSUNG
 HDBaseT Output: No Active Display
 HDBaseT Version: 7.0.08
 Wifi Mode: Access Point
 AP Info: Channel 48 - Power Level: 0
 Wifi Info: IP Addr: 192.168.43.1 - Mask: 255.255.255.0 - Gateway: null
 Ethernet Info: IP Addr: 10.1.0.146 - Mask: 255.255.254.0 - Gateway: 10.1.1.254
 Bluetooth status: Disabled
 PIN Code: Disabled
 Casting Services: Airplay GoogleCast Miracast
 Syslog Server: Disabled

Status

This page provides a information about the current state of the AT-UHD-SW-510W, such as IP information, memory usage, casting devices, active sources, date/time, and various other settings.

Configuration and Management Interfaces

Splash Screen page

This page provides control over the appearance of the splash screen. Refer to [The Splash Screen \(page 30\)](#) for more information on using each of the settings under the **Splash Screen** and **Images** window groups.

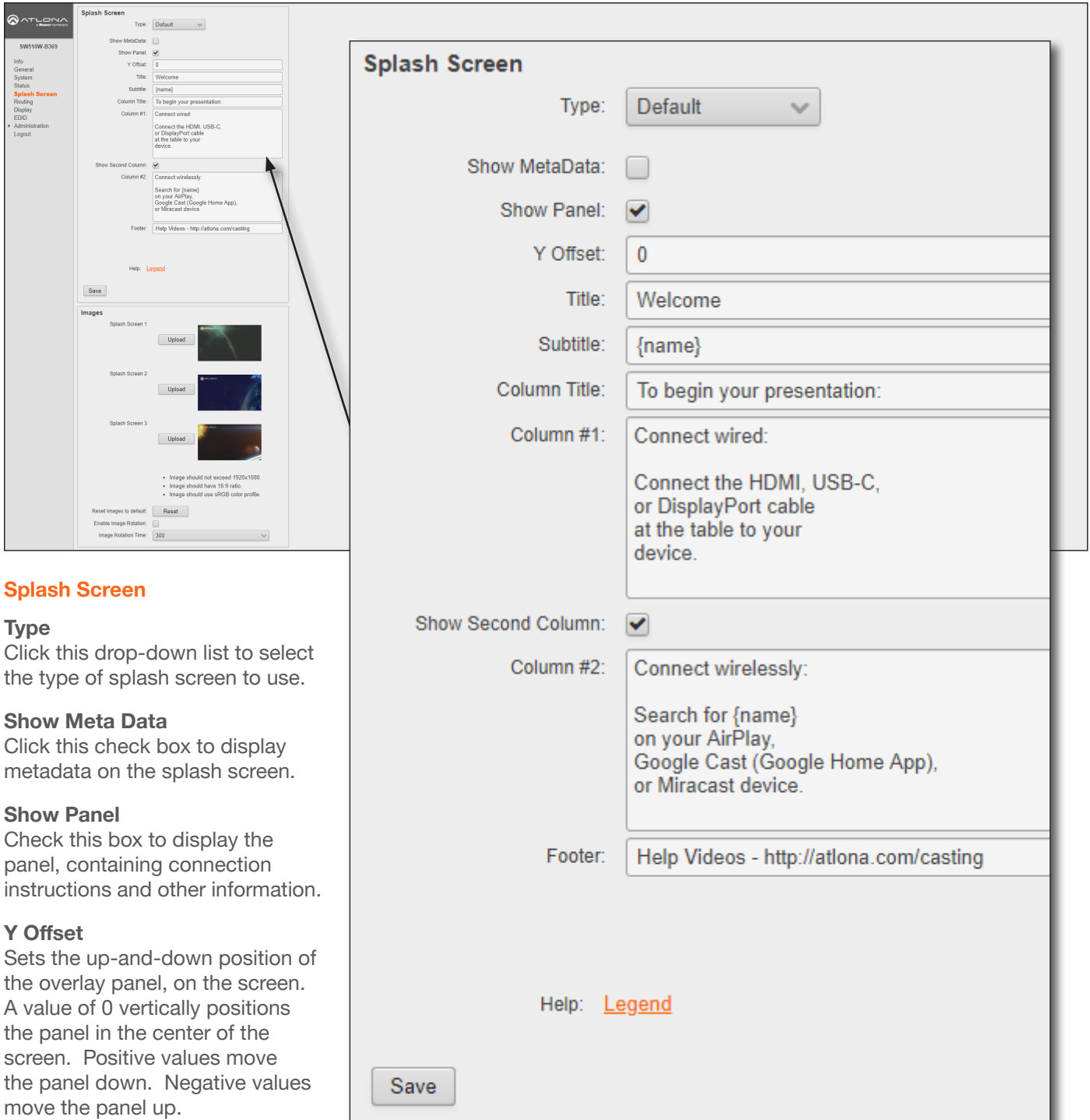

Splash Screen

Type: **Default**

Show MetaData:

Show Panel:

Y Offset: **0**

Title: **Welcome**

Subtitle: **{name}**

Column Title: **To begin your presentation:**

Column #1: **Connect wired:**
 Connect the HDMI, USB-C, or DisplayPort cable at the table to your device.

Show Second Column:

Column #2: **Connect wirelessly:**
 Search for {name} on your AirPlay, Google Cast (Google Home App), or Miracast device.

Footer: **Help Videos - http://atlonacomcasting**

Help: [Legend](#)

Save

Images

Splash Screen 1: **Upload**

Splash Screen 2: **Upload**

Splash Screen 3: **Upload**

Reset Images to default: **Reveal**

Enable Image Rotation:

Image Rotation Time: **300**

Splash Screen

Type

Click this drop-down list to select the type of splash screen to use.

Show Meta Data

Click this check box to display metadata on the splash screen.

Show Panel

Check this box to display the panel, containing connection instructions and other information.

Y Offset

Sets the up-and-down position of the overlay panel, on the screen. A value of 0 vertically positions the panel in the center of the screen. Positive values move the panel down. Negative values move the panel up.

Title

The title of the overlay panel. The default value is "Welcome".

Subtitle

The text directly under the text in the **Title** field. The default text contains the name of the unit.

Configuration and Management Interfaces

Column Title

The title text for the centered text, above both instruction columns. The default text is “To begin your presentation”.

Column #1

The text positioned in the left column. The default text is “Connect wired: Connect the HDMI, USB-C, or DisplayPort cable at the table to your device”.

Show Second Column

Check this box to display the second (right-hand) column. Uncheck this box to hide the text in this column.

Column #2

The text positioned in the right-hand column. The default text is “Connect wirelessly: Connect the Wi-Fi network”, entercode, and enable AirPlay, Google Cast™, or Miracast”.

Footer

By default, this field provides a link to how casting works on different operating systems (www.atlona.com/casting). This field can be modified to contain a different URL, if desired. This link will be displayed on the default splash screen.

Legend

Click this link to display a list of available tags that can be used in any of the text fields. Refer to the illustration above.

Save

Click this button to commit all changes on this page.

Splash Screen

Type:

Show MetaData:

Show Panel:

Y Offset:

Title:

Subtitle:

Column Title:

Column #1:

Show Second Column:

Column #2:

Footer:

Help: [Legend](#)

Configuration and Management Interfaces

Splash Screen

Type: Default

Show MetaData:

Show Panel:

Y Offset:

Title:

Subtitle:

Column Title:
 Column #1:

Show Second Column:
 Column #2:

Footer:

Help: [Legend](#)

Images

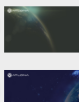
Splash Screen 1 

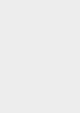
Splash Screen 2 

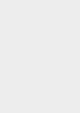
Splash Screen 3 

- Image should not exceed 1920x1080
- Image should have 16:9 ratio
- Image should use sRGB color profile

Reset images to default:

Enable Image Rotation:

Image Rotation Time:

Images

Splash Screen 1



Splash Screen 2



Splash Screen 3



- Image should not exceed 1920x1080.
- Image should have 16:9 ratio.
- Image should use sRGB color profile.

Reset Images to default:

Enable Image Rotation:

Image Rotation Time:

Images

Upload

Click these buttons to replace each factory-default image with a custom image.

Reset Splash Images

Click the **Reset** button to set the splash screen images to the factory-default images.

Enable Image Rotation

Click this check box to instruct the AT-UHD-SW-510W to cycle through the splash screen images.

Image Rotation Time

Click this drop-down list to select the image rotation interval.

Configuration and Management Interfaces

Routing page

This page provides control over the appearance of the splash screen. Refer to [The Splash Screen \(page 30\)](#) for more information on using each of the settings under the **Splash Screen** and **Images** window groups.

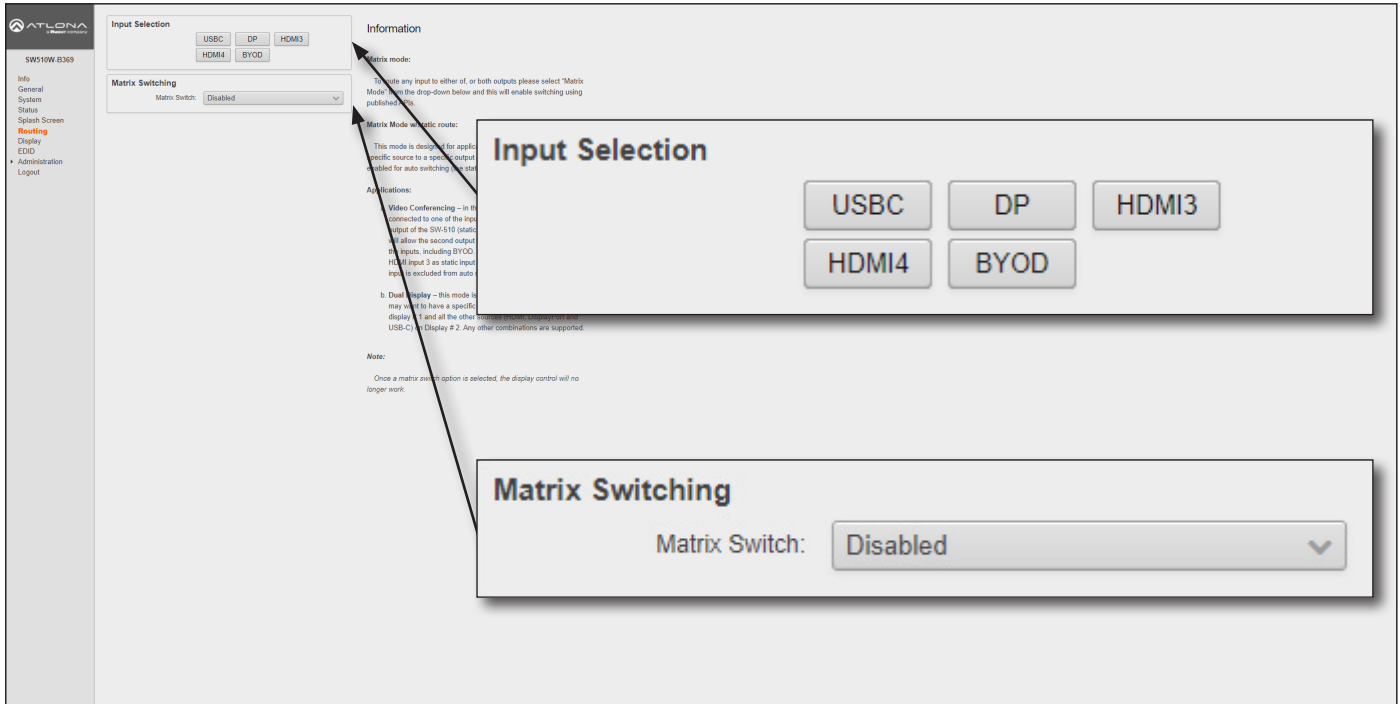

Input Selection

USBC, DP, HDMI3, HDMI4, BYOD

Click the desired button to select the active input.

Matrix Switching

Matrix Switch

Click this drop-down list to select the desired matrix mode. Refer to [Switching Modes \(page 25\)](#) for more information.

Modes	Description
Disabled	Matrix mode is disabled (default setting).
Matrix Mode	Allows the AT-UHD-SW-510W to independently switch between any input and any output.
Matrix Mode w/ Static Route	Use this mode when integrating the AT-UHD-SW-510W with a video conference system.

Configuration and Management Interfaces

Display page

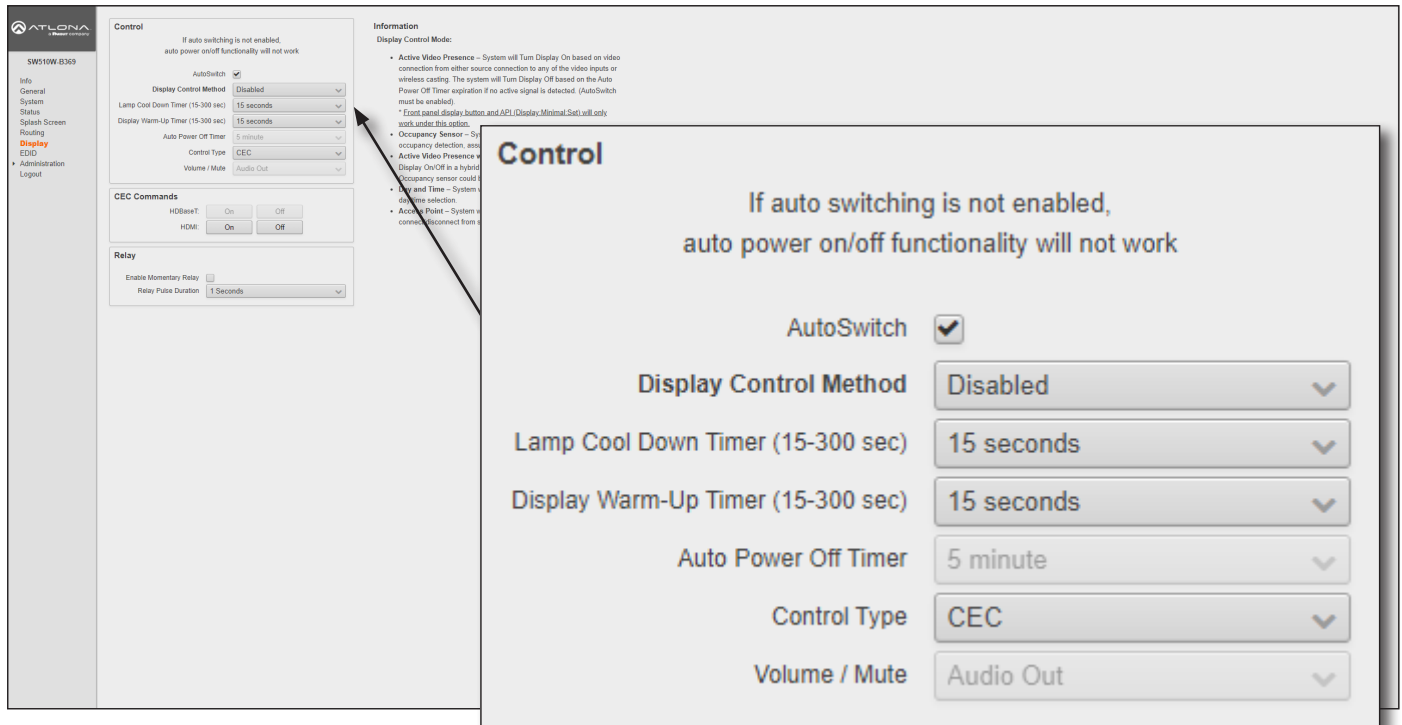

Control

AutoSwitch

Click this box to enable or disable auto-switching. When this box is checked, the AT-UHD-SW-510W will automatically switch inputs when the new device is connected. To disable auto-switching, uncheck this box.

Display Control Method

Click this drop-down list to select the method of display control. The following options are available.

Modes	Description
Active Video Presence*	The AT-UHD-SW-510W will power-off the display if no active source is detected on the input. Conversely, the display will power-on when an active source is detected. This applies to either physical source connections or casting. The Auto Power Off Timer must expire before the power-off command is sent.
Active Video Presence w/Occupancy Sensor*	Similar to the Active Video Presence mode, except that an occupancy sensor can also be used with Active Video Presence mode to determine when the power-off or power-on command is sent.
Occupancy Sensor	The AT-UHD-SW-510W will power-on/power-off the display based on the state of the occupancy sensor. The occupancy sensor must be wired to the AT-UHD-SW-510W.
Day and Time	The AT-UHD-SW-510W will power-on/power-off the display based on the assigned schedule.
Access Point	Display will power-on/power-off based on the presence of a connection/disconnection from the AT-UHD-SW-510W Access Point.
Disabled	No display control

*AutoSwitch must be enabled to use these control methods.

Configuration and Management Interfaces

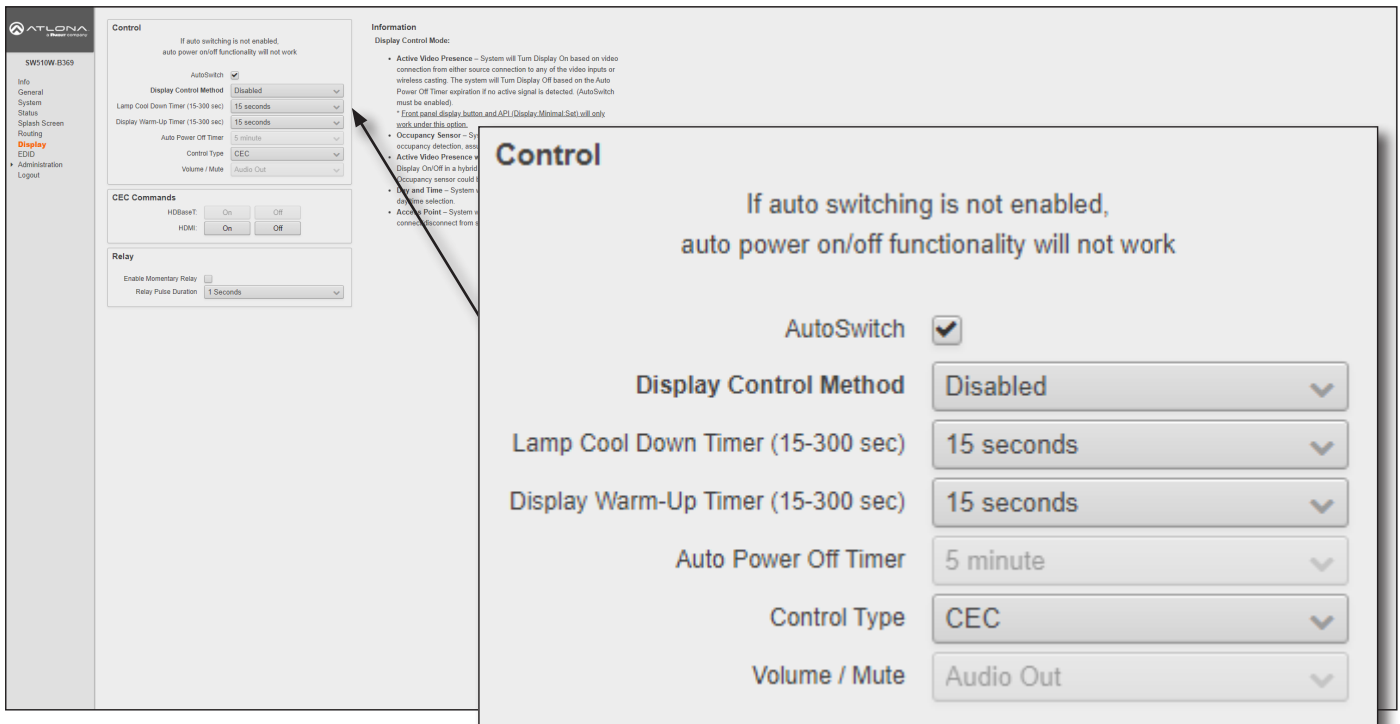

Lamp cool down timer

Sets the projector lamp cool-down timer, in seconds. This value specifies the time interval that must elapse, after the display control “off” command is sent, before the display “power on” command can be sent. This feature is used to prevent the projector from missing a “power on” command while the lamps are cooling. A minimum of 45 seconds is recommended for projectors. Available values are from 15 to 300 seconds (5 minutes). The default setting is 15 seconds.

Display Warm-Up Timer

Sets the projector lamp warm-up timer, in seconds. During the warm-up interval, the AT-UHD-SW-510W will not start the auto power-off timer. This value specifies the time interval that must elapse, after the display control “on” command is sent, before the display “power off” command can be sent. This feature is used to prevent a “power off” command from being sent while the lamps are warming up. A minimum of 45 seconds is recommended for projectors. Available values are 15 to 300 seconds (5 minutes). The default value is 15 seconds.

Auto power off timer

Sets the time interval before the command to power-off the display is sent, when an A/V signal is no longer present. The default value is 5 minutes. Available values are 15 seconds to 8 hours.

Control Type

Sets the control protocol for the connected display. Click this drop-down to select the control type. Available settings are **CEC**, **IP**, and **RS-232**. By default, CEC is selected for control of the display. IP and RS-232 can also be selected. When IP or RS-232 are selected, more fields are available.

Volume / Mute

This option is only available when **Control Type** is set to **RS-232** or **IP**.

Configuration and Management Interfaces

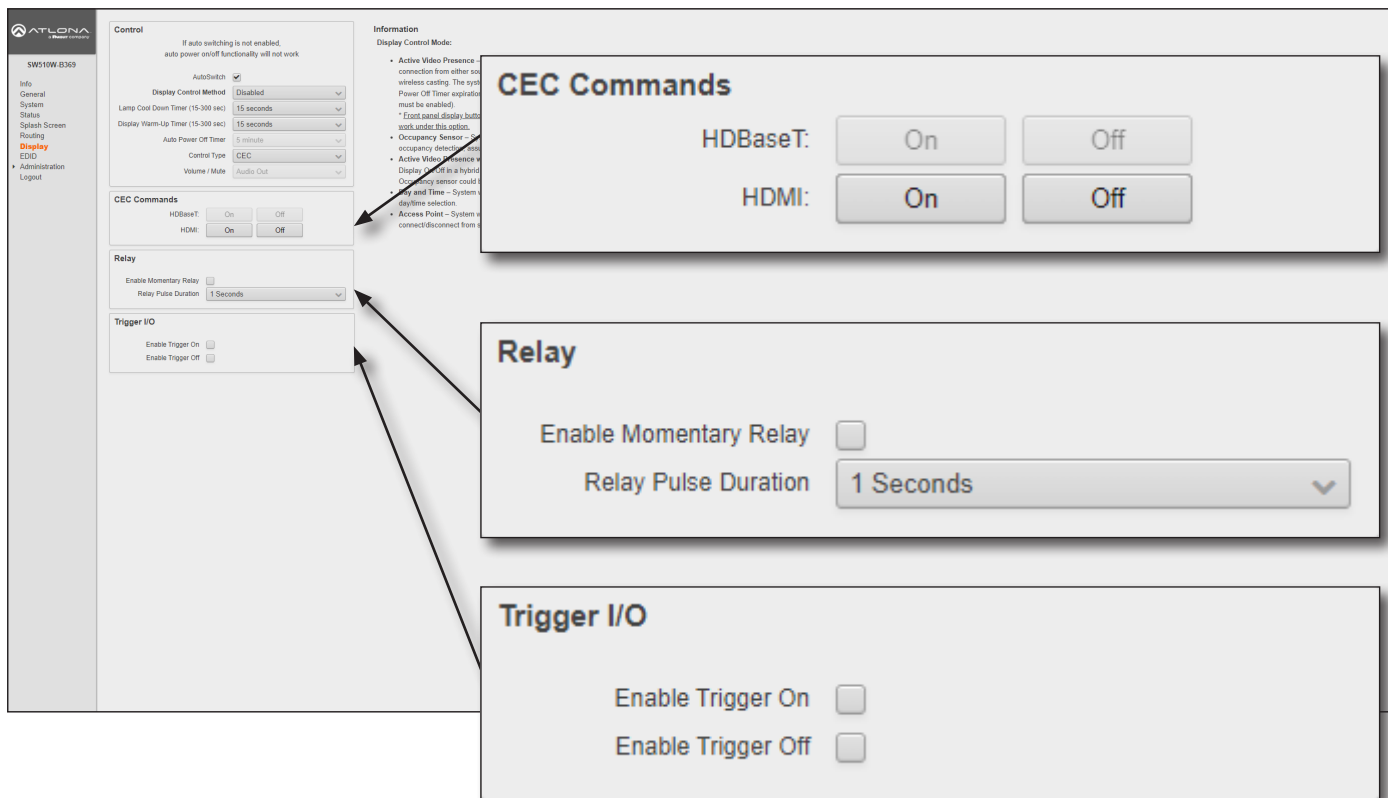

The screenshot shows the ATLONA configuration interface for device SW510W-R369. The interface is divided into several sections:

- Control:** Contains settings for AutoSwitch, Display Control Method (Disabled), Lamp Cool Down Timer (15-300 sec), Display Warm-Up Timer (15-300 sec), Auto Power Off Timer (5 minute), Control Type (CEC), and Volume / Mute (Audio Out).
- CEC Commands:** Features On/Off buttons for HDBaseT and HDMI.
- Relay:** Includes an Enable Momentary Relay checkbox and a Relay Pulse Duration dropdown menu set to 1 Seconds.
- Trigger I/O:** Contains checkboxes for Enable Trigger On and Enable Trigger Off.

Callout boxes on the right side of the image provide detailed views of these sections:

- CEC Commands:** Shows HDBaseT and HDMI sections, each with On and Off buttons.
- Relay:** Shows the Enable Momentary Relay checkbox and the Relay Pulse Duration dropdown menu.
- Trigger I/O:** Shows the Enable Trigger On and Enable Trigger Off checkboxes.

CEC Commands

Click these buttons to test CEC functionality over HDMI and HDBaseT. Click the **On** button to send the power-on command to the display device. Click the **Off** button to send the power-off command to the display device.

Relay

Enable Momentary Relay

When enabled, the relay is set to momentary. The default setting is disabled (latch). Use a 48 V DC relay with no more than 1 A current draw. This feature is disabled, by default. Refer to [Relay \(page 11\)](#) for wiring information.

Relay Pulse Duration

Click this drop-down list to select the desired pulse duration for the relay. Some devices may require different time intervals, to recognize a state change. Range: 1 to 10 seconds.

Trigger I/O

This section defines how the **TRIGGER** port will respond to varying voltage levels when, for example, used with an occupancy sensor. Either or both of the following conditions can be enabled or disabled. This section is only available when the **Display Control Method** is set to either **Occupancy Sensor** or **Active Video Presence w/ Occupancy Sensor**.

Enable Trigger On

Check this box to power-on the system when the occupancy sensor detects a presence in the room. If the **Enable Trigger Off** is not checked (enabled), then the system power will remain on when the room is unoccupied.

Enable Trigger Off

Check this box to power-off the system when the occupancy sensor detects no presence in the room.

Configuration and Management Interfaces

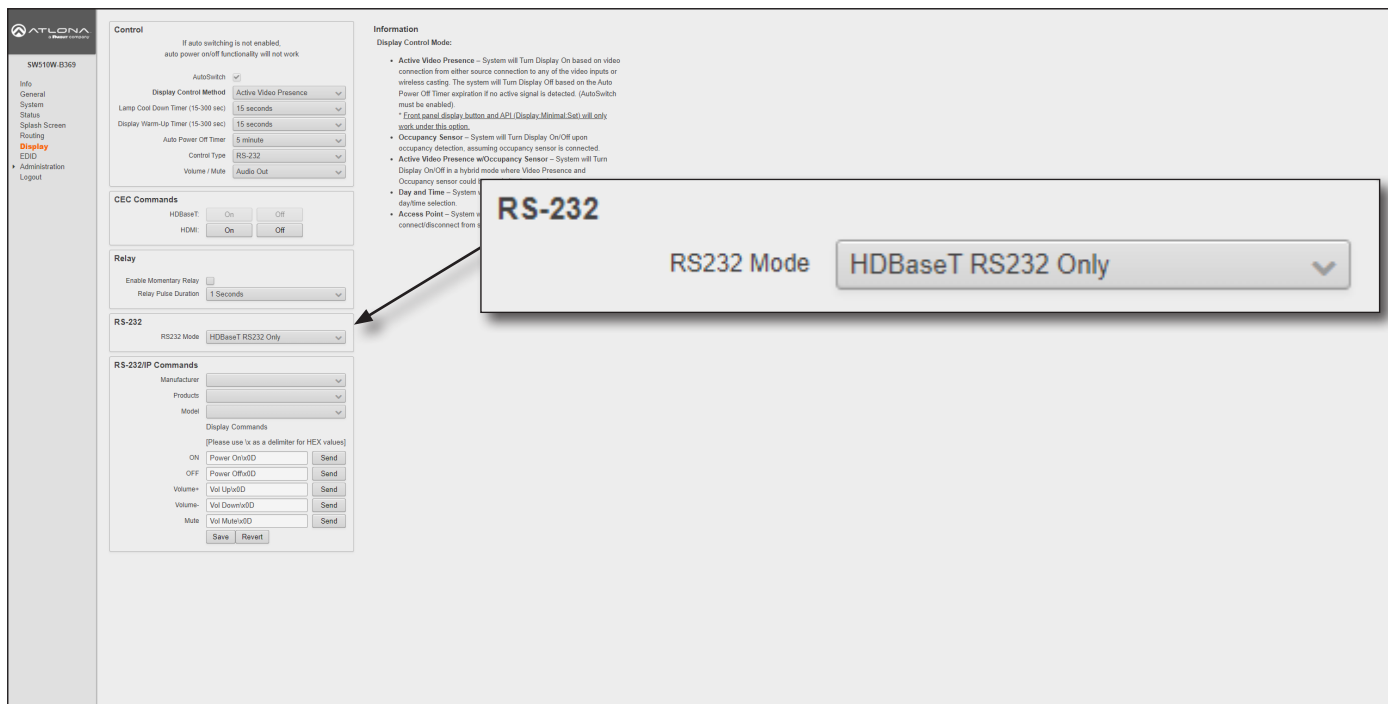

RS-232

This section is only available when the **Control Type** is set to **RS-232**. If RS-232 settings (baud rate, etc) need to be adjusted, refer to the **RS232 Settings** section under the **Administration > Advanced page (page 102)**.

RS-232 Mode

Click this drop-down list to select the RS-232 mode.

Setting	Description
HDBaseT RS232 Only	Assigns settings for RS-232 settings over HDBaseT OUT . RS-232 commands will only be transmitted over the HDBaseT OUT port.
Local RS232 Only	Assigns settings for RS-232 port for controlling the display over the local RS-232 port.
Both	Both HDBaseT OUT and the RS-232 port are used. Note that when using both ports, the RS-232 settings must be identical.

Configuration and Management Interfaces

Control

If auto switching is not enabled, auto power on/off functionality will not work.

AutoSwitch

Display Control Method: Disabled

Lamp Cool Down Timer (15-300 sec): 15 seconds

Display Warm-Up Timer (15-300 sec): 15 seconds

Auto Power Off Timer: 5 minute

Control Type: IP

Volume / Mute: Audio Out

CEC Commands

HDBaseT: On OFF

HDMI: On OFF

Relay

Enable Momentary Relay:

Relay Pulse Duration: 1 Seconds

IP

IP address: 10.20.50.58

Port [0-65535]: 23

Information

Display Control Mode:

- Active Video Presence – System will Turn Display On based on video connection from either source connection to any of the video inputs or wireless casting. The system will Turn Display Off based on the Auto Power Off Timer expiration if no active signal is detected. (AutoSwitch must be enabled).
- Front panel display button and API (Display_Minimal_Set) will only work under this setting.
- Occupancy Sensor – System will Turn Display On/Off upon occupancy detection, assuming occupancy sensor is connected.
- Active Video Presence + Display On/Off as a hybrid.
- Occupancy sensor could.
- Day and Time – System, daytime selection.
- Access Point – System connect/disconnect from.

IP

IP address: 10.20.50.58

Port [0-65535]: 23

RS-232/IP Commands

Manufacturer: [Dropdown]

Products: [Dropdown]

Model: [Dropdown]

Display Commands

[Please use \x as a delimiter for HEX values]

ON: Power On\x0D [Send]

OFF: Power Off\x0D [Send]

Volume+: Vol Up\x0D [Send]

Volume-: Vol Down\x0D [Send]

Mute: Vol Mute\x0D [Send]

[Save] [Revert]

IP
This section is only available when the **Control Type** is set to **IP**.

IP address
Enter the IP address of the display device in this field.

Port
Enter the port number in this field.

RS-232/IP Commands
This section is only available when the **Control Type** is set to either **RS-232** or **IP**.

Manufacturer
Click this drop-down list to select the display manufacturer. If the display device being controlled is not in this list, then the commands can be entered manually.

Acer	Hitachi	Qomo
Barco	Infocus	Samsung
Benq	JVC	Sharp
Canon	LG	Smart
Casio	NEC	Sony
Christie	Optima	Toshiba
Clevertouch	Panasonic	ViewSonic
Digital Projection	Philips	Vivitek
Eiki	Pjlink	
Epson	Planar	

Configuration and Management Interfaces

RS-232/IP Commands

Manufacturer

Products

Model

Display Commands

[Please use \x as a delimiter for HEX values]

ON	<input type="text" value="Power On\x0D"/>	<input type="button" value="Send"/>
OFF	<input type="text" value="Power Off\x0D"/>	<input type="button" value="Send"/>
Volume+	<input type="text" value="Vol Up\x0D"/>	<input type="button" value="Send"/>
Volume-	<input type="text" value="Vol Down\x0D"/>	<input type="button" value="Send"/>
Mute	<input type="text" value="Vol Mute\x0D"/>	<input type="button" value="Send"/>

Products

Click this drop-down list to select the product. This drop-down list will be populated, based on the selection made from the **Manufacturer** drop-down list.

Model

Click this drop-down list to select the model. This drop-down list will be populated based on the selection made in the **Products** drop-down list.

Display Commands

Once a device is selected, the **ON**, **OFF**, **Volume+**, **Volume-**, and **Mute** fields will be populated with the correct information for that device. If a device is not listed, enter the appropriate commands the device in each field. Commands can be either ASCII or hexadecimal. If hexadecimal values are used, then use the /x delimiter at the end of the string. Click the **Send** button to verify that each command works properly. If not, check the values entered for each command.

Save

Click this button to commit all changes.

Revert

Click this button to undo all changes.

Configuration and Management Interfaces

EDID page

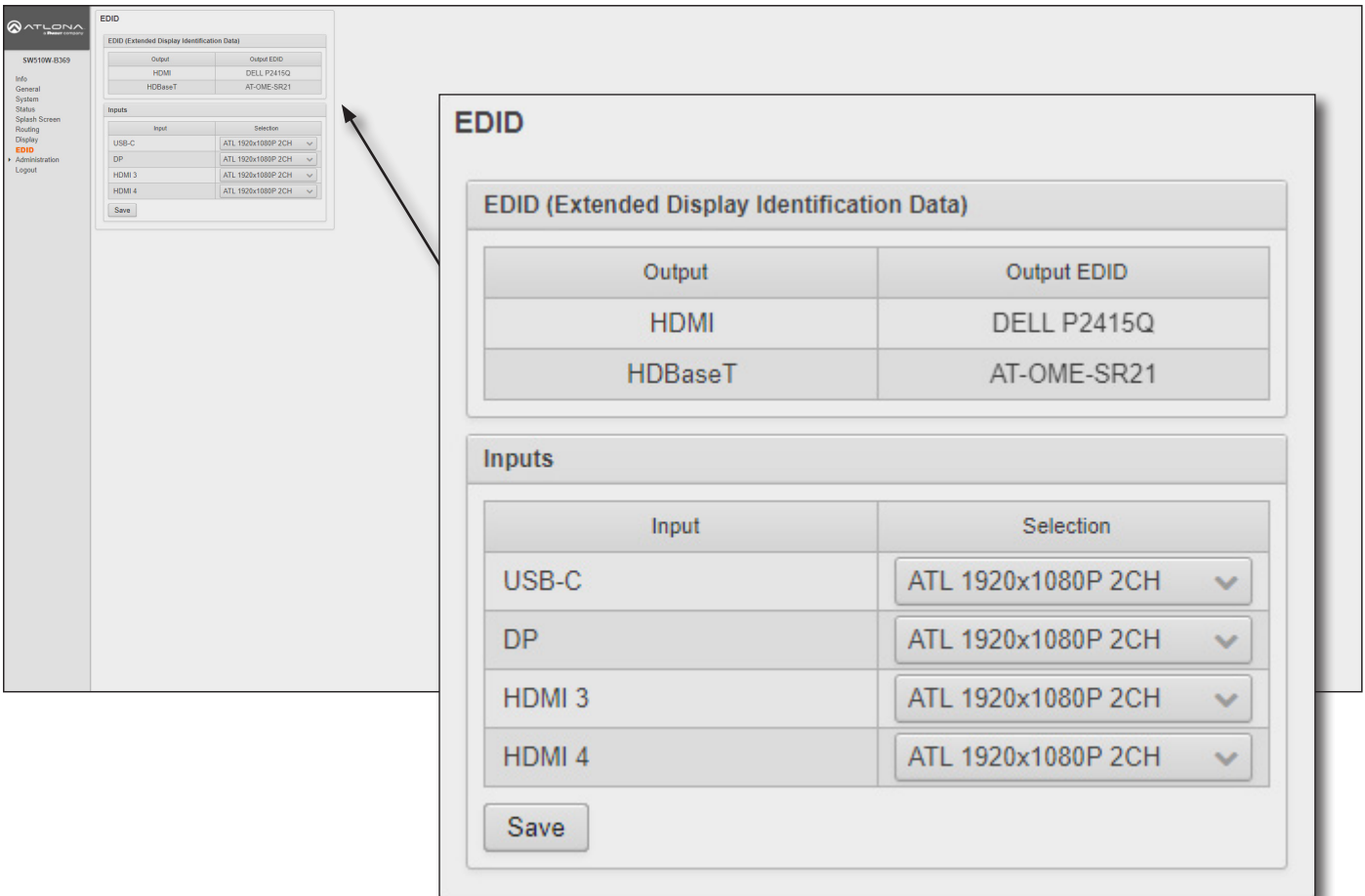

EDID

EDID (Extended Display Identification Data)

Displays the EDID assigned that is being used by each output. Press the **Save** button to save the EDID to a file.

Inputs

The **Input** column displays each of the inputs on the AT-UHD-SW-510W. Click the drop-down list, under the **Selection** column, to select the desired EDID to be used. The table below lists the available EDID presets.

The table below provides a listing of available EDID presets.

EDID listing	
4K60 2CH	1366x768@60 2CH
4K30 2CH	1280x800p60 2CH
4K30 4:4:4 2CH	1280x720p60 2CH
1920x1200p60 2CH	1024x768p60 2CH
1920x1080P 2CH (factory-default)	800x600p60 2CH
1600x900p@60 2CH	

Save

Click this button to commit changes.

Configuration and Management Interfaces

Administration > Telnet page

The **Telnet** page provides an emulated terminal for entering commands.

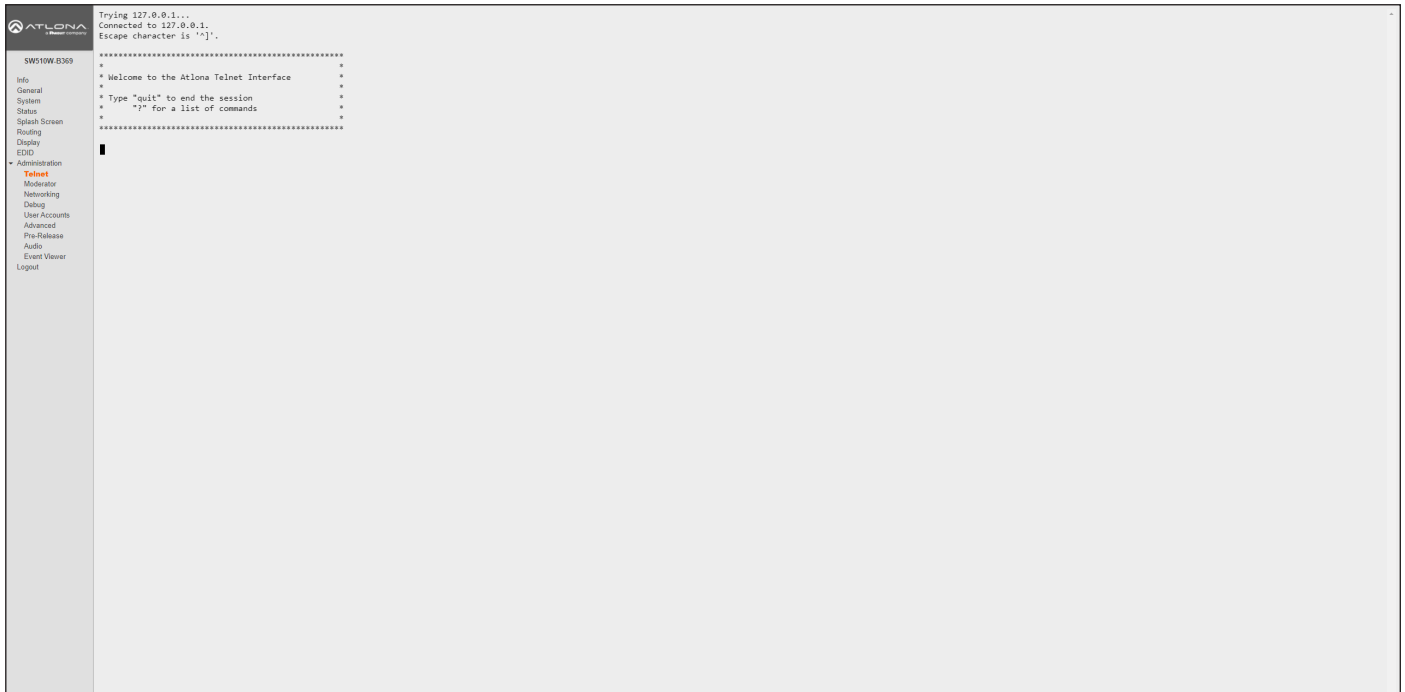

Configuration and Management Interfaces

Administration > Moderator page

The **Moderator** page provides control of which device, that are casting, are permitted to display content. Refer to [Moderator Mode \(page 62\)](#) for more information.

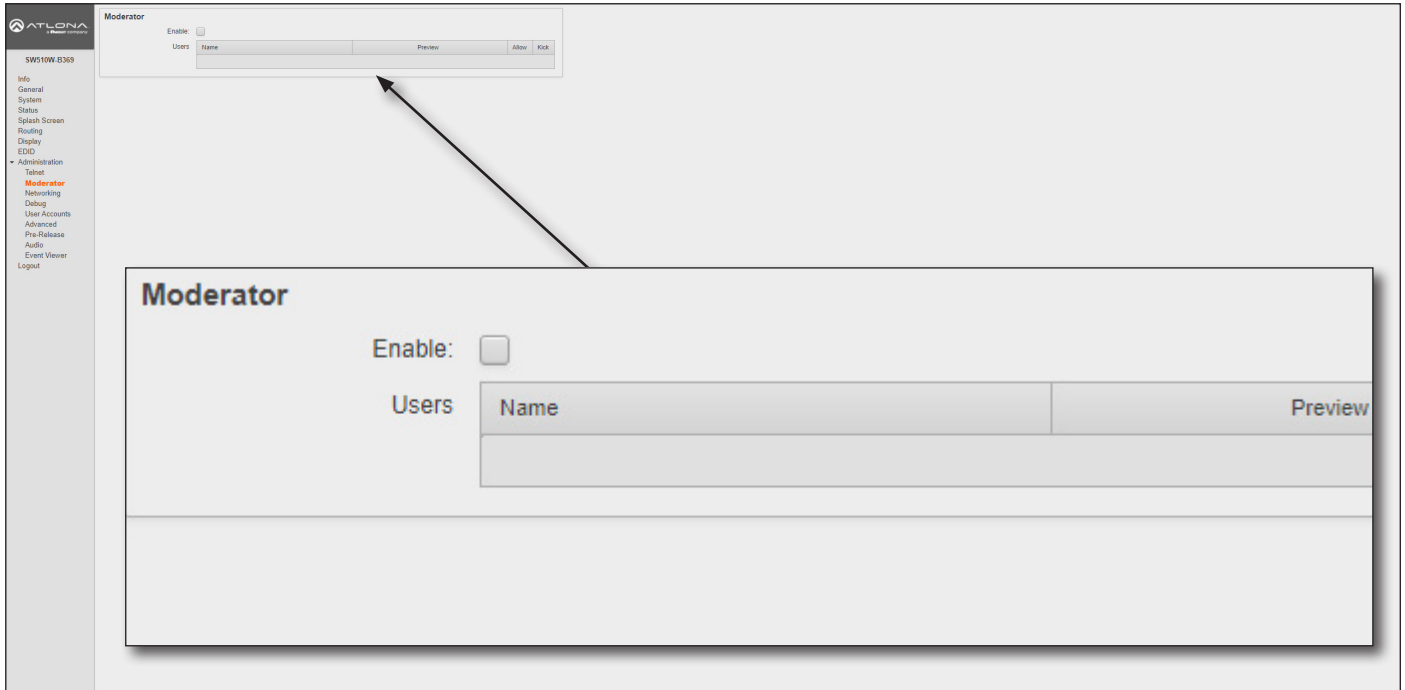

Moderator

Enable

Click this check box to enable or disable Moderator mode. If this box is checked, then Moderator mode is enabled. In order to monitor which devices are allowed to display content, this box must be checked before a device begins casting. If a device is already casting, then enabling this feature will have no effect.

Users

This table lists all users which are casting using the AT-UHD-SW-510W. Up to four users can be hosted at one time, but only one can be displayed at a time. Devices will only appear in this table when they are casting. Moderator mode must be enabled for devices to be displayed in this table. When casting devices are displays an **Allow** and **Kick** button will also be displayed.

Configuration and Management Interfaces

Administration > Networking page

This page contains a **WiFi** and **Ethernet** tab. Use the settings, under these tabs, to connect the AT-UHD-SW-510W to a network or wireless Access Point (AP). Refer to the IT Network Deployment Guide for detailed information on configuring the AT-UHD-SW-510W in various network environments.

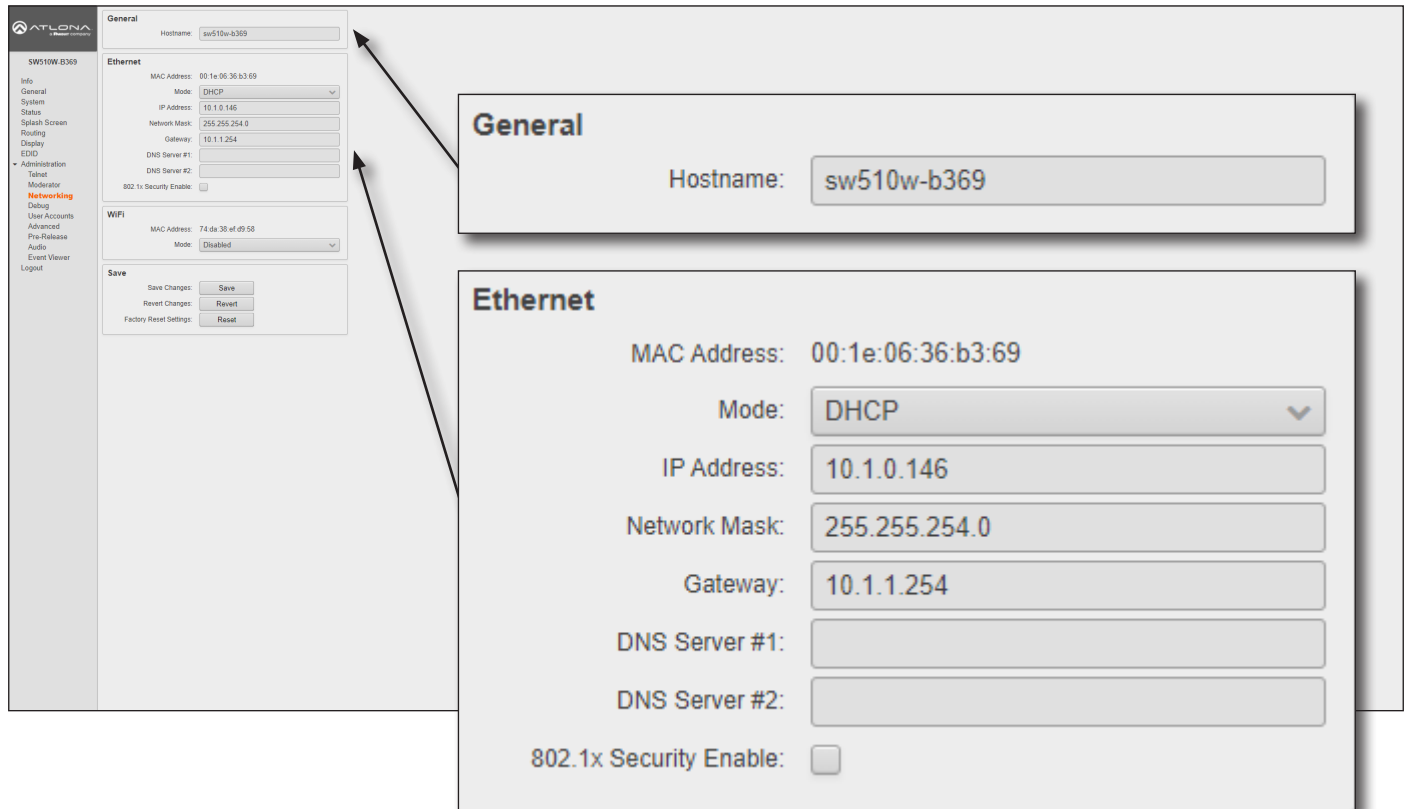

The screenshot shows the configuration interface for the AT-UHD-SW-510W. The left sidebar contains a navigation menu with options like Info, General, System, Status, Splash Screen, Routing, Display, EDID, Administration, Tablet, Moderator, **Networking**, Debug, User Accounts, Advanced, Pre-Release, Audio, Event Viewer, and Logout. The main content area is divided into two tabs: **General** and **Ethernet**. The **General** tab shows the Hostname set to 'sw510w-b369'. The **Ethernet** tab shows the MAC Address as '00:1e:06:36:b3:69', Mode set to 'DHCP', IP Address as '10.1.0.146', Network Mask as '255.255.254.0', and Gateway as '10.1.1.254'. There are also fields for DNS Server #1 and #2, and a checkbox for '802.1x Security Enable'. A 'Save' section at the bottom of the Ethernet tab includes 'Save Changes', 'Revert Changes', and 'Factory Reset Settings' buttons.

General

Hostname

The name assigned to the AT-UHD-SW-510W. This name can be changed, if desired. Refer to [Changing the SSID \(page 48\)](#) for more information.

Ethernet

MAC Address

Displays the MAC address of the AT-UHD-SW-510W.

Mode

Click this drop-down list to select the desired IP mode.

Setting	Description
DHCP	Select this option to have a DHCP server (if available) assign an IP address to the AT-UHD-SW-510W.
Static	Select this option to enter a specific IP address. When set to Static mode, the subnet mask, gateway, and DNS servers can be specified.
Factory Static	Select this option to use the factory-default wired network settings. In this mode, only the DNS Server fields can be modified. The IP Address , Network Mask , and Gateway fields will be set to the following values: <ul style="list-style-type: none"> IP Address = 192.168.1.254 Network Mask = 255.255.0.0 Gateway = 192.168.1.1

Configuration and Management Interfaces

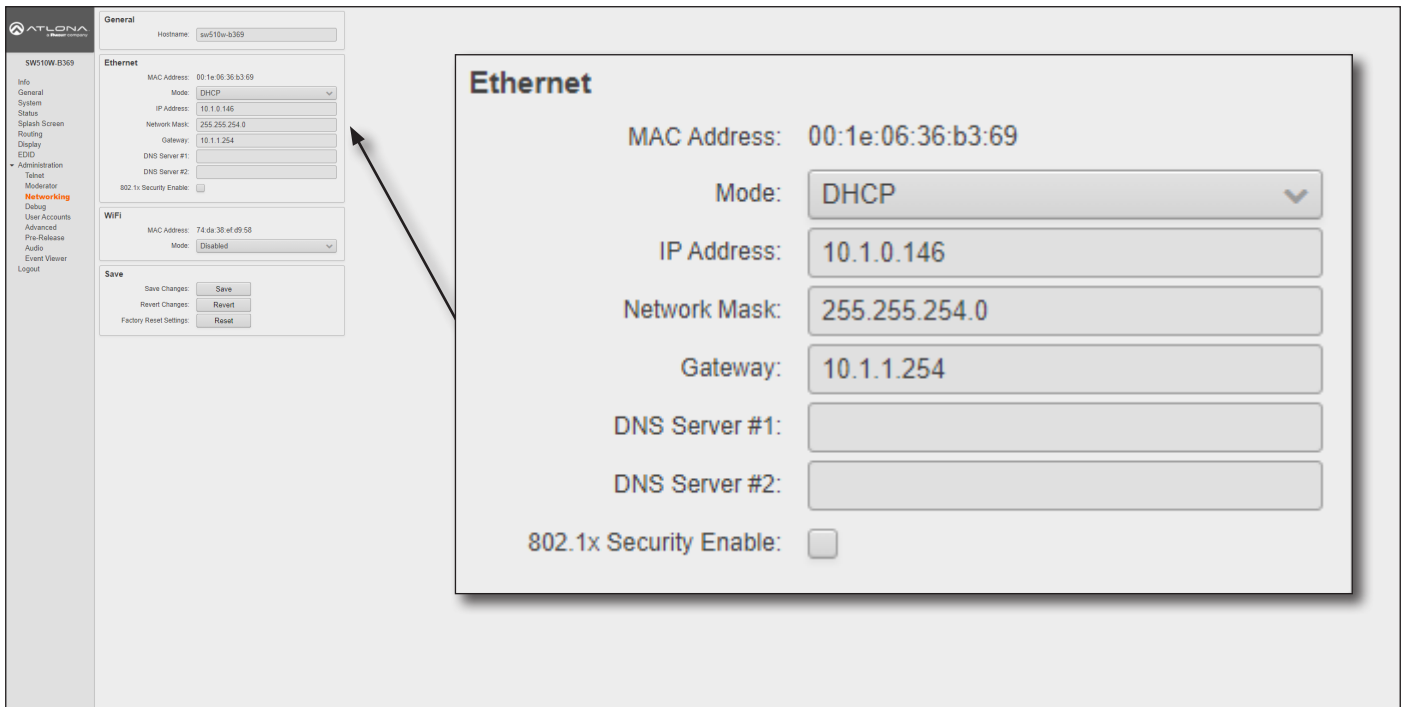

IP Address

Enter the desired IP address for the AT-UHD-SW-510W in this field. This field can only be changed when **Mode** is set to **Static**.

Network Mask

Enter the subnet mask in this field. This field can only be changed when **Mode** is set to **Static**.

Gateway

Enter the gateway (router) address in this field. This field can only be changed when **Mode** is set to **Static**.

DNS Server #1 / DNS Server #2

Enter the DNS server addresses in the DNS Server #1 and DNS Server #2 fields. If the AT-UHD-SW-510W will be used within an internal LAN, this information is not required. This field can only be changed when **Mode** is set to **Static**.

802.1x Security Enable

Click this checkbox to enable 802.1x authentication mode. When enabled, the Radius server, Radius port, and Radius secret fields will be available. Refer to [802.1X Authentication \(page 49\)](#) for more information.

Configuration and Management Interfaces

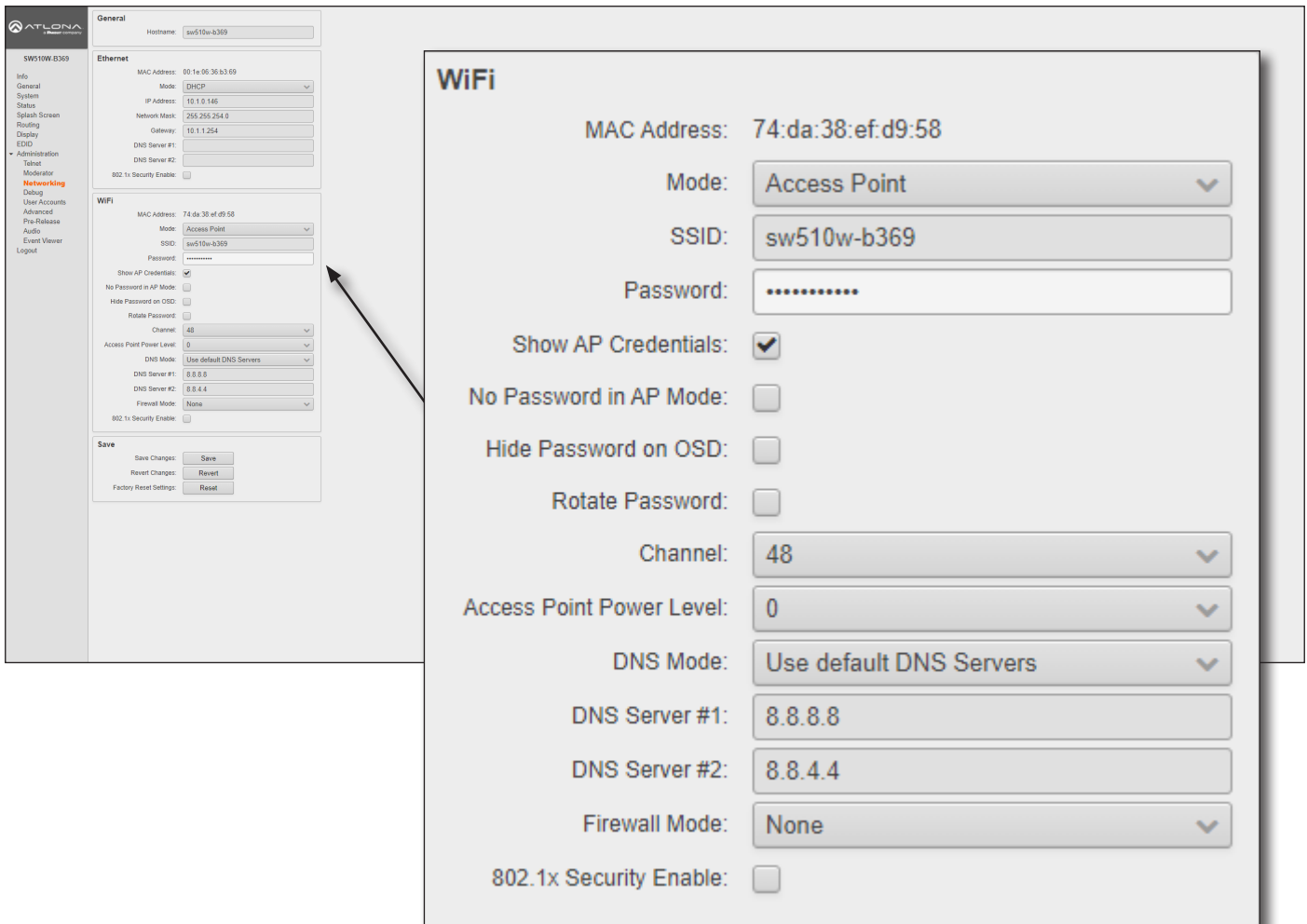

WiFi - Access Point Mode

Mode

Click this drop-down list to select the desired WiFi mode.

Setting	Description
Access Point	Select this option to configure the AT-UHD-SW-510W as a Wireless Access Point, allowing other wireless devices to connect to the same wired network as the AT-UHD-SW-510W.
Connect to WiFi	Select this mode to connect the AT-UHD-SW-510W to the specified SSID of a wireless host.
Disabled	Select this mode to disable Wi-Fi on the AT-UHD-SW-510W.

SSID

The SSID assigned to the AT-UHD-SW-510W. The SSID name can be changed. Refer to [Changing the SSID \(page 48\)](#) for more information.

Password

Enter the password required to connect to the AT-UHD-SW-510W.

Show AP Credentials

Check this box to display the Username and Password credentials on the splash screen.

Hide Password on OSD

By default, the password will be displayed on the splash screen. Check this box to hide the password on the splash screen.

Configuration and Management Interfaces

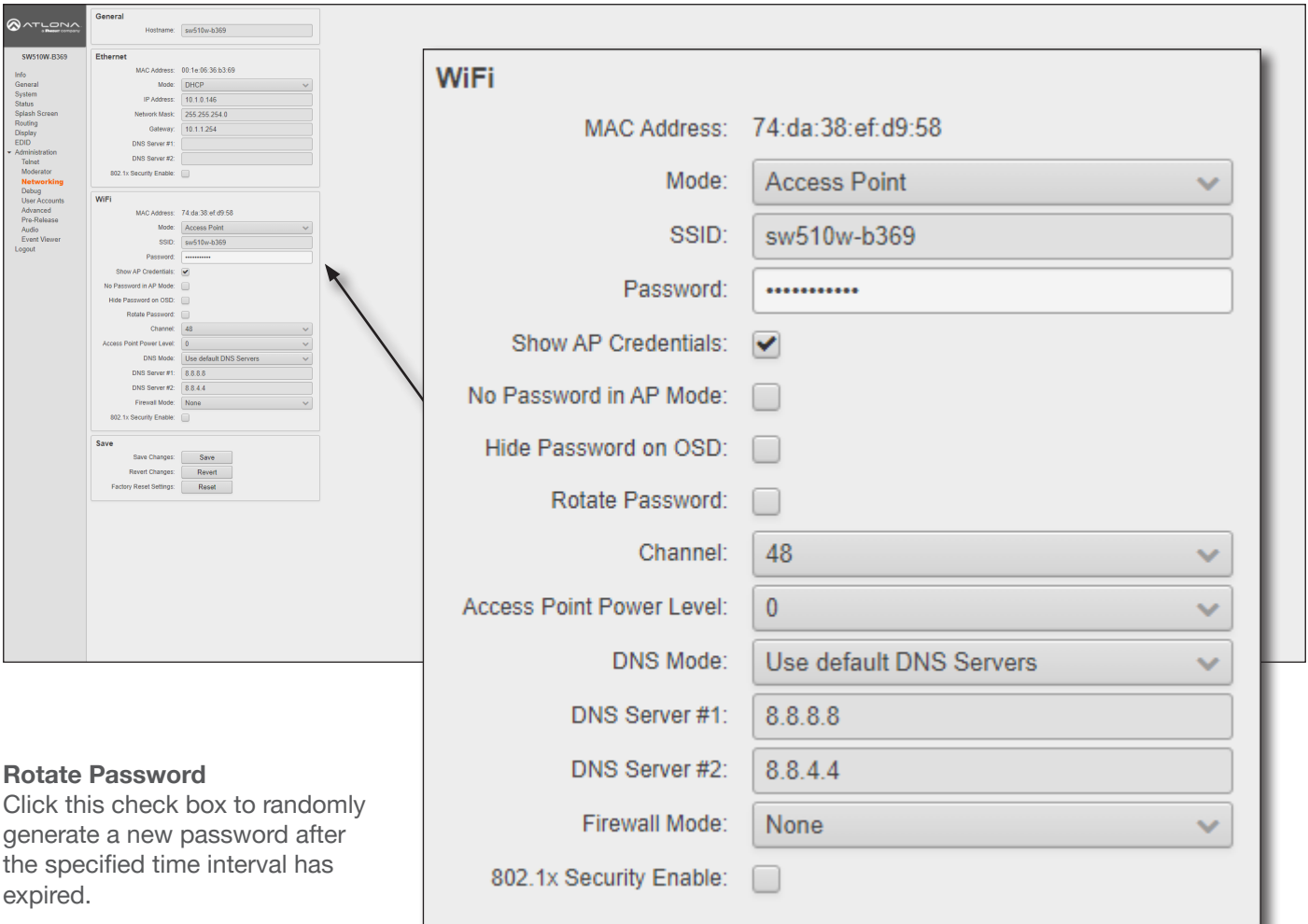

Rotate Password

Click this check box to randomly generate a new password after the specified time interval has expired.

Channel

Click this drop-down list to select the desired wireless channel. Channels 1 through 11 are 2.5 GHz channels. Channels 36 and above are 5 GHz channels. Contact the network administrator if necessary.

Access Point Power Level

Sets the transmission power of the USB WiFi antennas. Click the drop-down list to select the power level. Available values are integers 0 through 13. Lower values will reduce transmission power of the USB WiFi antenna, thus limiting the range of the Access Point on the AT-UHD-SW-510W.

DNS Mode

Click this drop-down list to select the desired DNS mode.

DNS Server #1 / DNS Server #2

Enter the DNS server addresses in the **DNS Server #1** and **DNS Server #2** fields. If the AT-UHD-SW-510W will be used within an internal LAN, this information is not required.

Firewall Mode

This feature is only available when the WiFi mode is set to Access Point. Click the **Firewall Mode** drop-down list to select the desired mode. This feature allows control of incoming and outgoing network traffic. The AT-UHD-SW-510W provides the following firewall modes: **Block Private Network**, **Block Internet**, **Block All**, and **None**. Refer to [Firewall Mode \(page 44\)](#) for more information.

802.1x Security Enable

Click this checkbox to enable 802.1x authentication mode. When enabled, the Radius server, Radius port, and Radius secret fields will be available. Refer to [802.1X Authentication \(page 49\)](#) for more information.

Configuration and Management Interfaces

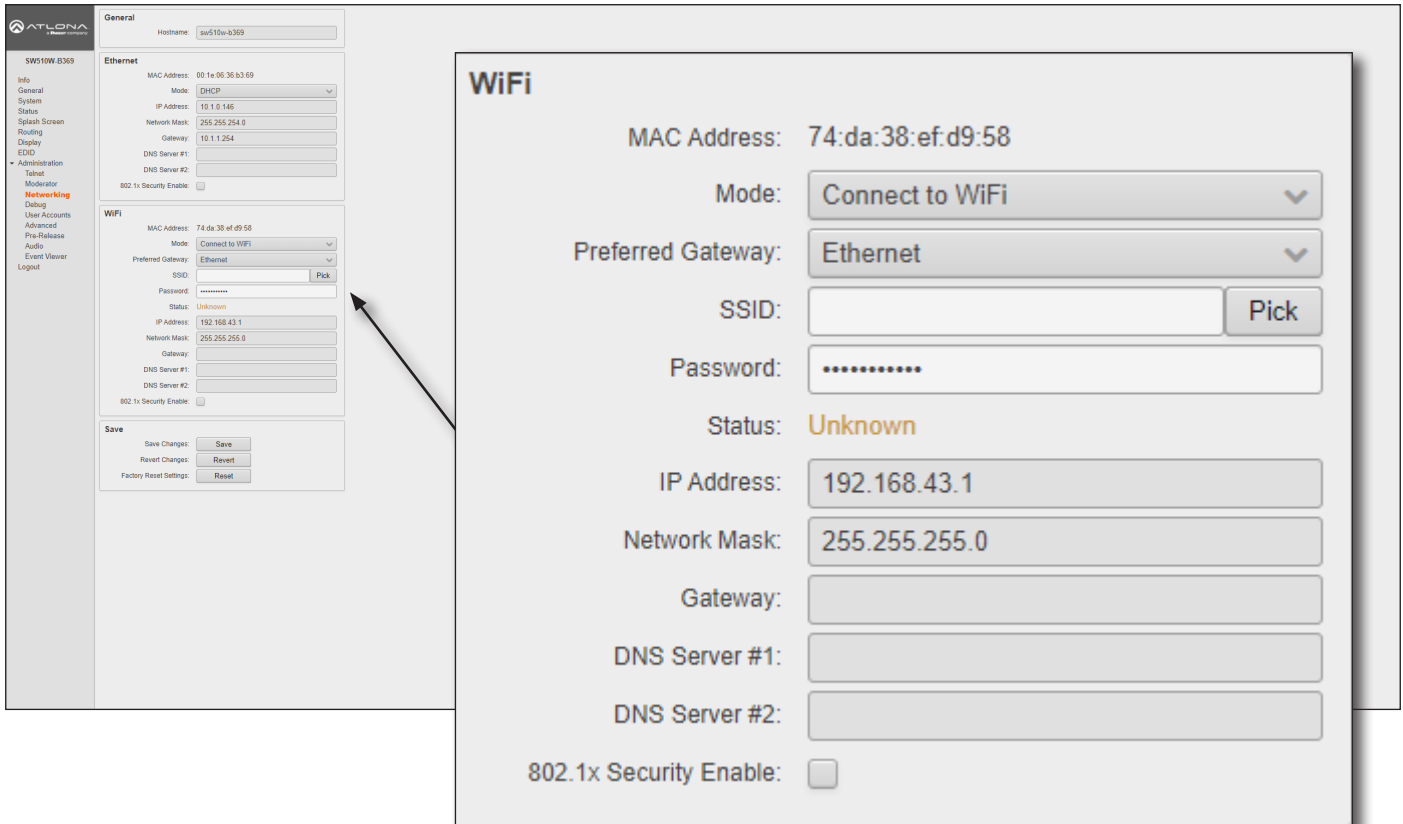

WiFi - Connect to WiFi Mode

Mode

Click this drop-down list to select the desired WiFi mode.

Setting	Description
Access Point	Select this option to configure the AT-UHD-SW-510W as a Wireless Access Point, allowing other wireless devices to connect to the same wired network as the AT-UHD-SW-510W.
Connect to WiFi	Select this mode to connect the AT-UHD-SW-510W to the specified SSID of a wireless host.
Disabled	Select this mode to disable Wi-Fi on the AT-UHD-SW-510W.

Preferred Gateway

When set to **Connect to WiFi** mode, the AT-UHD-SW-510W can only be accessed through the same network, over Ethernet or WiFi, not both. For example, if **Ethernet** is selected, then the AT-UHD-SW-510W can only be accessed from the same network over Ethernet. However, it should be noted that casting is supported on *both* interfaces, simultaneously.

SSID

Click the **Pick** button to display a pop-up dialog displaying all available WiFi networks. Click the desired WiFi network from the list and click the **OK** button to accept the selection or click **Cancel** to return without making a WiFi network selection. When a wireless network is selected, its name will appear in the **SSID** field.

Password

Enter the password required to connect to the wireless network, in this field.

Status

This field indicates the connection state. If no connection is present, then this field will indicate `Unknown`. Once a valid wireless connection has been established, this field will indicate `Connected`.

Configuration and Management Interfaces

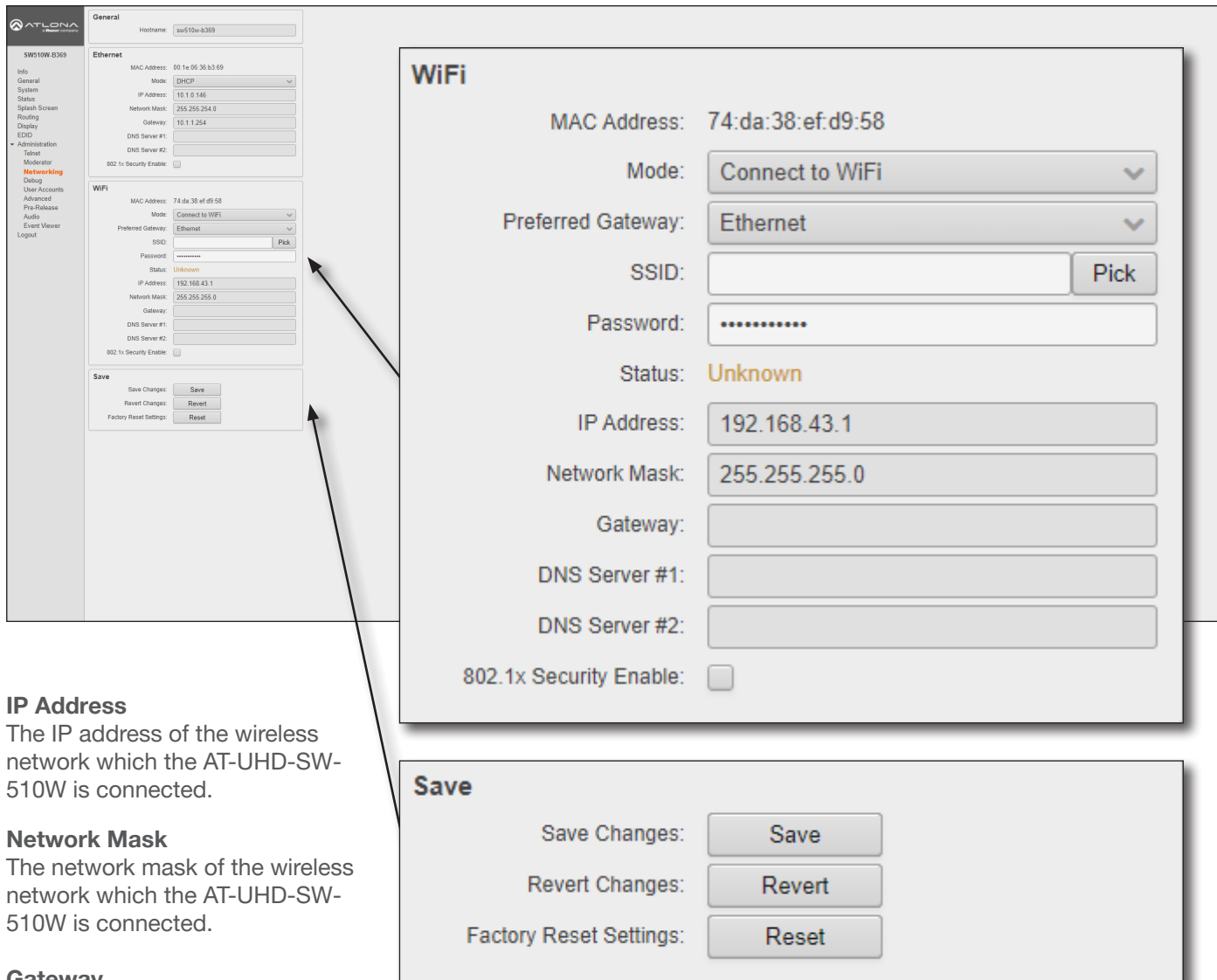

The screenshot shows the ATLONA configuration interface. The left sidebar contains a menu with options like Info, General, System, Status, Splash Screen, Routing, Display, EDID, Administration, Telet, Moderator, Networking, Debug, User Accounts, Advanced, Pre-Release, Audio, Event Viewer, and Logout. The main content area is divided into sections: General, Ethernet, WiFi, and Save. The WiFi section is highlighted with a callout box. The WiFi section includes fields for MAC Address, Mode, Preferred Gateway, SSID, Password, Status, IP Address, Network Mask, Gateway, DNS Server #1, DNS Server #2, and 802.1x Security Enable. The Save section includes buttons for Save Changes, Revert Changes, and Factory Reset Settings.

IP Address

The IP address of the wireless network which the AT-UHD-SW-510W is connected.

Network Mask

The network mask of the wireless network which the AT-UHD-SW-510W is connected.

Gateway

This field cannot be changed.

DNS Server #1 / DNS Server #2

These fields cannot be changed.

802.1x Security Enable

Click this checkbox to enable 802.1x authentication mode. When enabled, the Radius Server, Radius Port, and Radius Secret fields will be available. Refer to [802.1X Authentication \(page 49\)](#) for more information.

Save

Save

Click this button to commit changes within the **Network** menu.

Revert

Click to abort changes.

Reset

Click this button to reset the network settings to factory-default settings.

Configuration and Management Interfaces

Administration > Debug page

Click the **Download Logs** button to download the debug logs. Debug logs are downloaded in a .zip file. Debug logs are used by Atlona Technical Support Engineers to identify functionality issues.

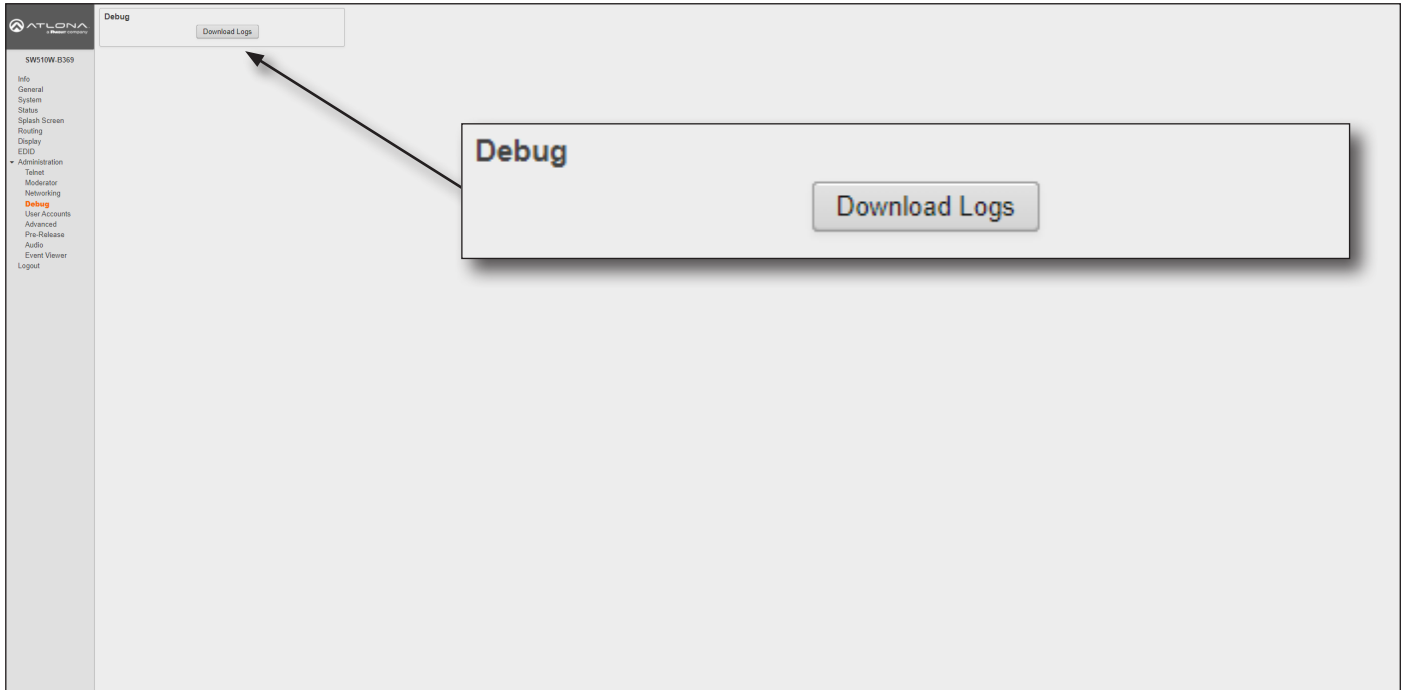

1. Click **Debug** on the side menu bar.
2. Click the **Downloads Logs** button to display the **Save As** dialog box.
3. Browse to the desired folder where the .zip file will be downloaded.
4. Click the **Save** button on the **Save As** dialog to save the debug log file.

Configuration and Management Interfaces

Administration > User Accounts page

This page allows the default password to be changed.

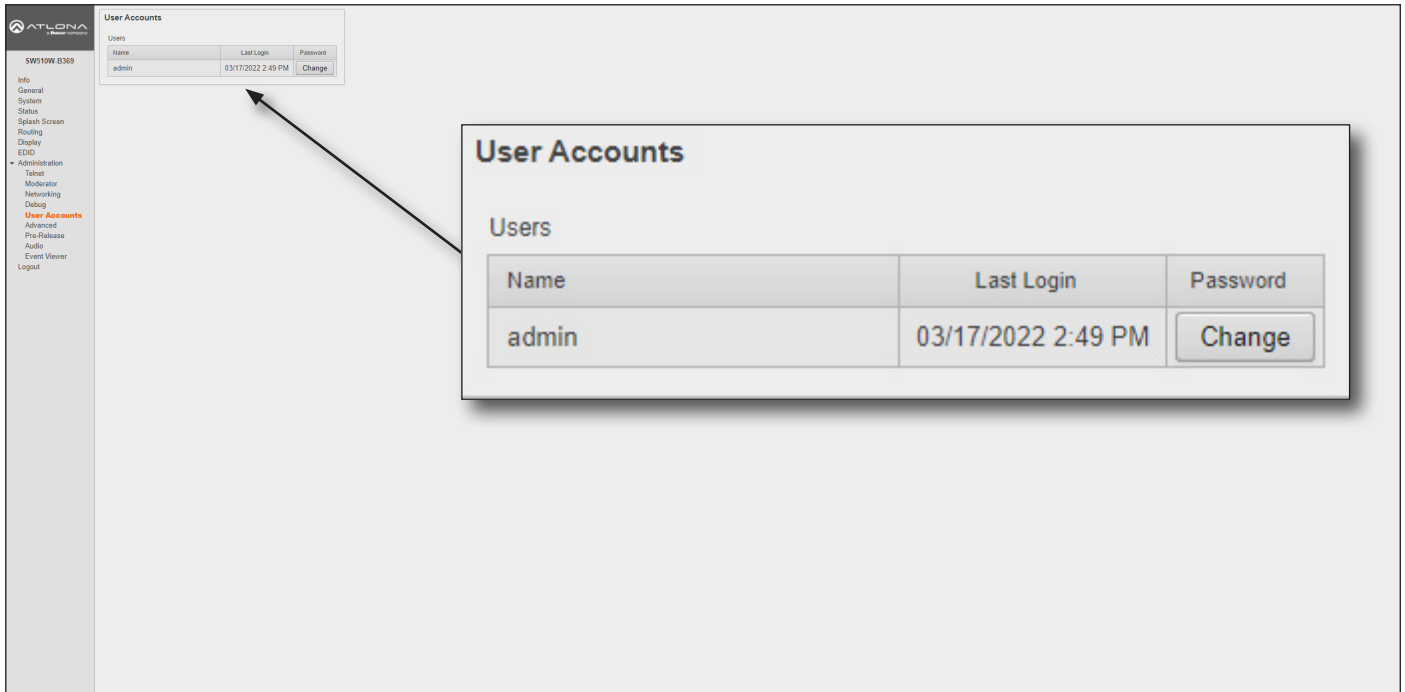

1. Click the **Change** button to display the **Change Password** dialog box.

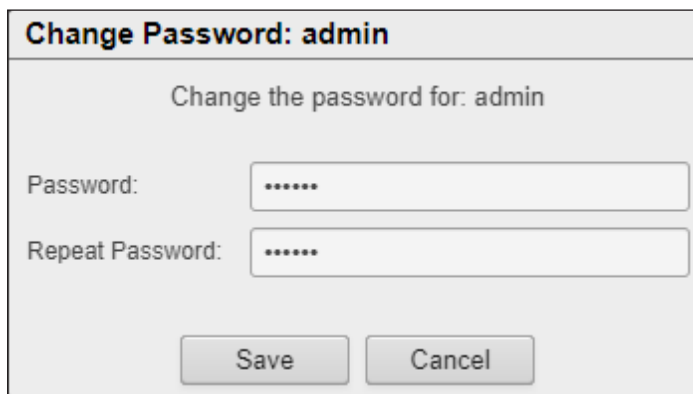

Change Password: admin

Change the password for: admin

Password:

Repeat Password:

Save Cancel

2. Enter the new password in the **Password** field.
3. Re-enter the same password in the **Repeat Password** field.
4. Click the **Save** button to commit changes or click **Cancel** to abort the process.

Configuration and Management Interfaces

Administration > Advanced page

This page provides options for advanced functionality.

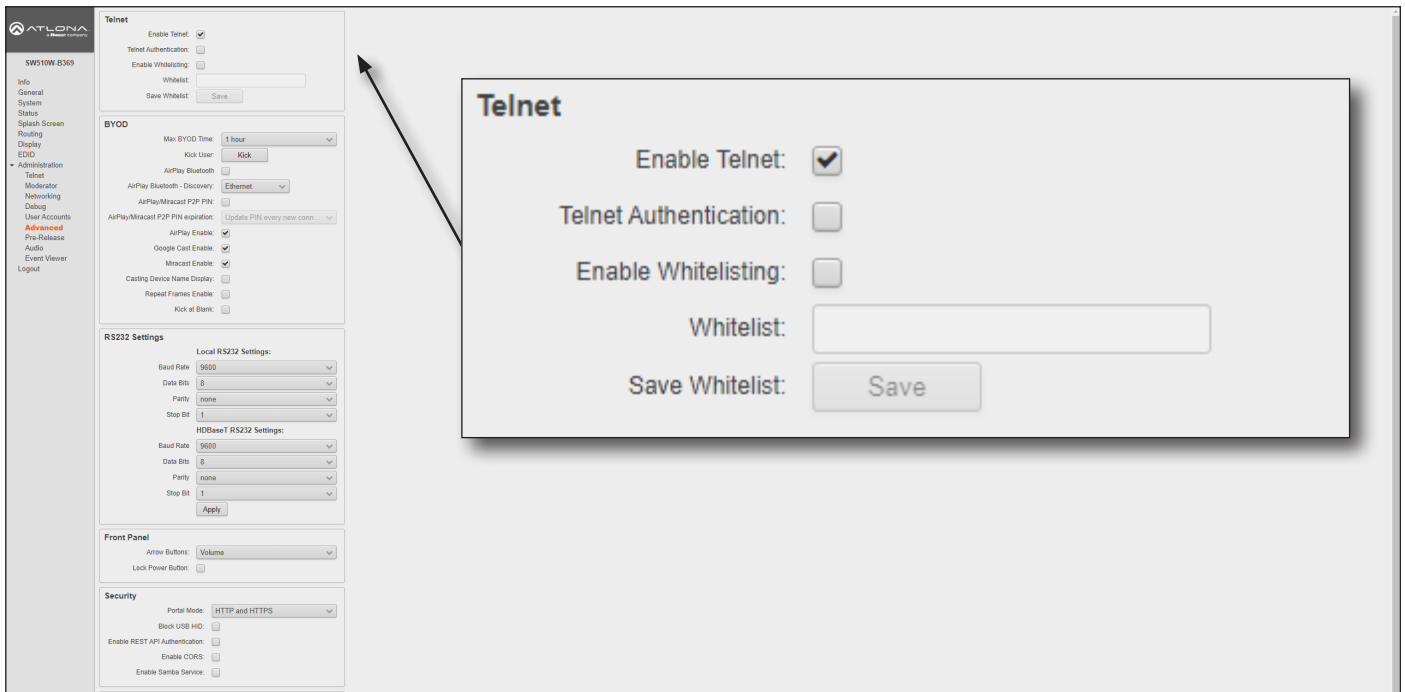

Telnet

Enable Telnet

Click this check box to enable or disable the Telnet protocol for the AT-UHD-SW-510W. When checked, Telnet is enabled.

Telnet Authentication

Click this check box to enable or disable the Telnet authentication. When checked, Telnet is enabled. When this feature is enabled, username and password credentials will be required at the beginning of the Telnet session.

Enable Whitelisting

Click this check box to enable whitelisting. Whitelisting only allows Telnet access to those users within the specified network. Users outside the network will not be granted access.

Whitelist

Enter the network IP address using CIDR notation (e.g. 192.168.11.1/24), in this field. Multiple network IP addresses can be specified with a comma and space: 192.168.11.1/24, 10.0.1.1/24.

Save Whitelist

Click the **Save** button to save the whitelist field.

Configuration and Management Interfaces

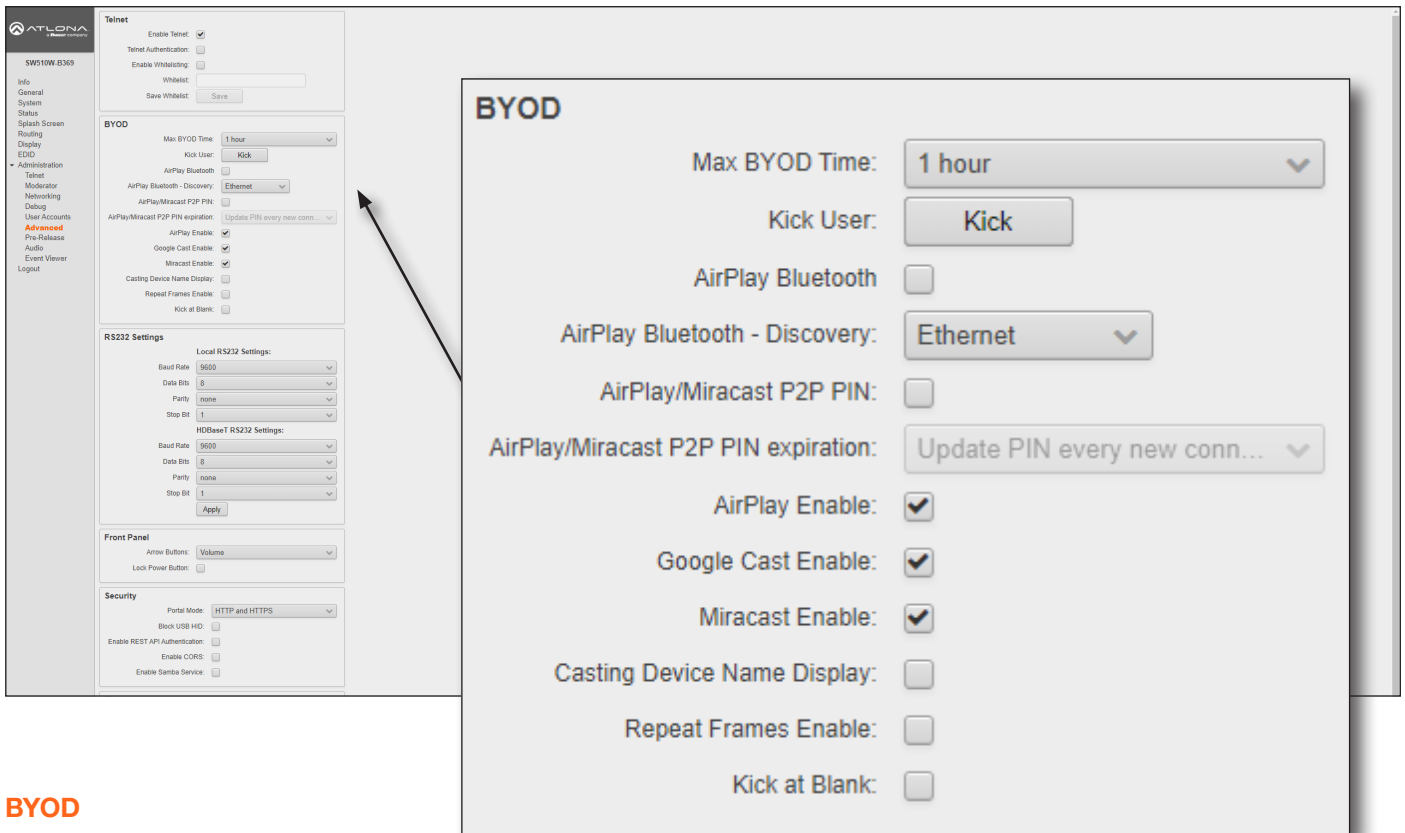

BYOD

Max BYOD Time

Click this drop-down list to select the desired time interval before the connected BYOD is automatically disconnected from the AT-UHD-SW-510W. Available options are 35 minutes to 5 hours.

Kick User

Click this button to disconnect the current BYOD.

Airplay Bluetooth - Ethernet

Click this check box to enable Bluetooth discovery when using an Ethernet connection. Refer to [AirPlay Bluetooth Discovery \(page 58\)](#) for more information.

Airplay Bluetooth - WiFi

Click this check box to enable Bluetooth discovery when using a WiFi connection. Refer to [AirPlay Bluetooth Discovery \(page 58\)](#) for more information.

Airplay/Miracast P2P PIN

Click this check box to allow the ability to add randomized PIN codes when connecting using AirPlay.

Airplay/Miracast P2P PIN expiration

Click this drop-down list to select the time interval before a new PIN code is requested by the system. This drop-down list is only available if the **Airplay/Miracast P2P PIN** check box is checked.

Setting	Description
Update Pin every new connection	A new PIN code is generated each time a device attempts to connect to the AT-UHD-SW-510W.
Update Pin every 15 minutes	A new PIN is generated every 15 minutes, whether or not a connection request is made.
Update Pin every 60 seconds	A new PIN is generated every 60 minutes, whether or not a connection request is made.

Configuration and Management Interfaces

Airplay Enable

Click this check box to enable AirPlay. This option is enabled by default.

Google Cast Enable

Click this check box to enable Google Cast™. This option is enabled by default.

Miracast Enable

Click this check box to enable Miracast. This option is enabled by default.

Casting Device Name display

Check this box to show the hostname of the casting device on the splash screen.

Kick at Blank

Click this check box to allow the AT-UHD-SW-510W to kick the wireless BYOD client when the device goes to sleep.

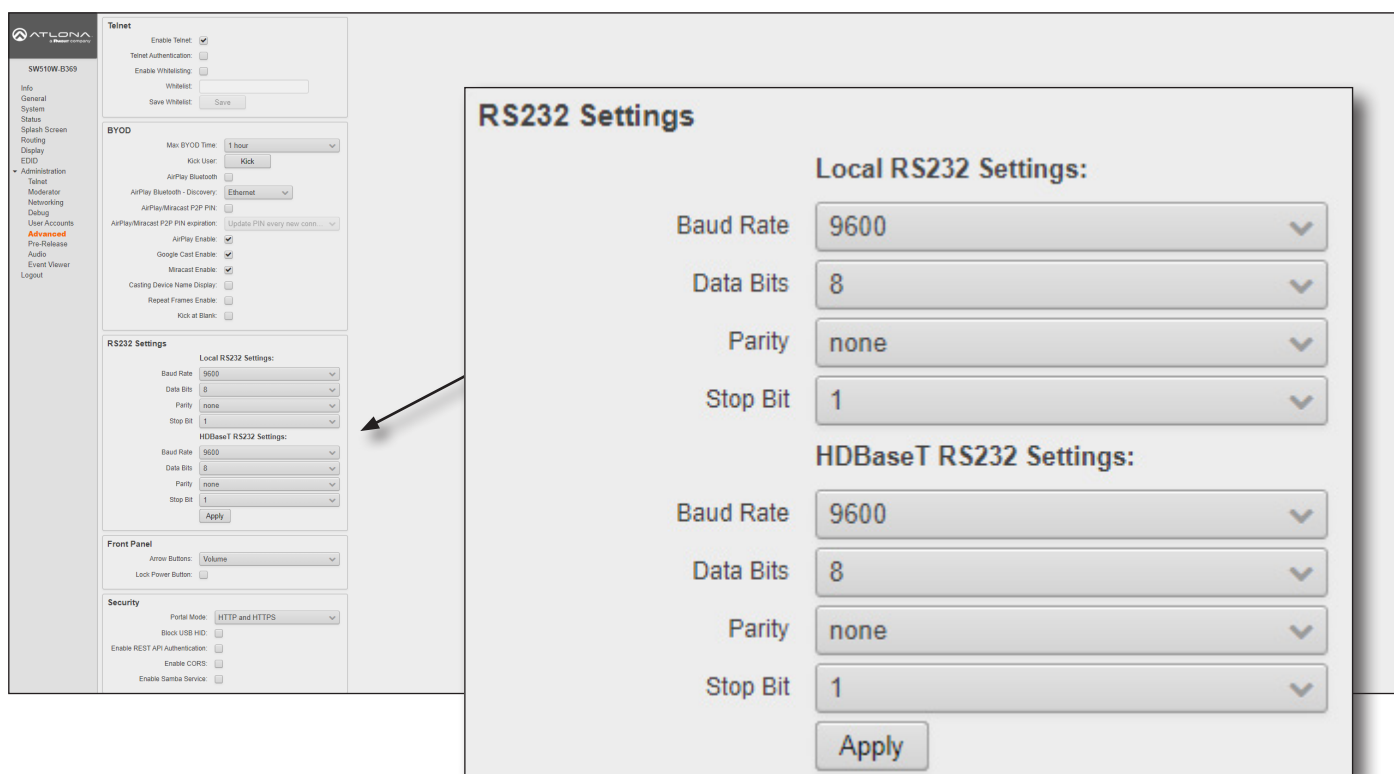

RS232 Settings

Baud Rate, Data Bits, Parity, and Stop Bits

The RS-232 settings for the selected RS-232 mode.

Setting	Description
Baud rate	Sets the baud rate. The following options are available: 9600, 14400, 19200, 38400, 57600, 115200.
Data bit	Sets the number of data bits used to represent each character of data. The following options are available: 7 or 8.
Parity	Sets the parity bit, which can be included with each character to detect errors during the transmission of data. The following options are available: None, Odd, or Even.
Stop bit	Sets the stop bit. Stop bits are sent at the end of each character, allowing the client to detect the end of a character stream. The following options are available: 1 or 2.

Apply

Click this button to apply changes to the RS232 settings.

Configuration and Management Interfaces

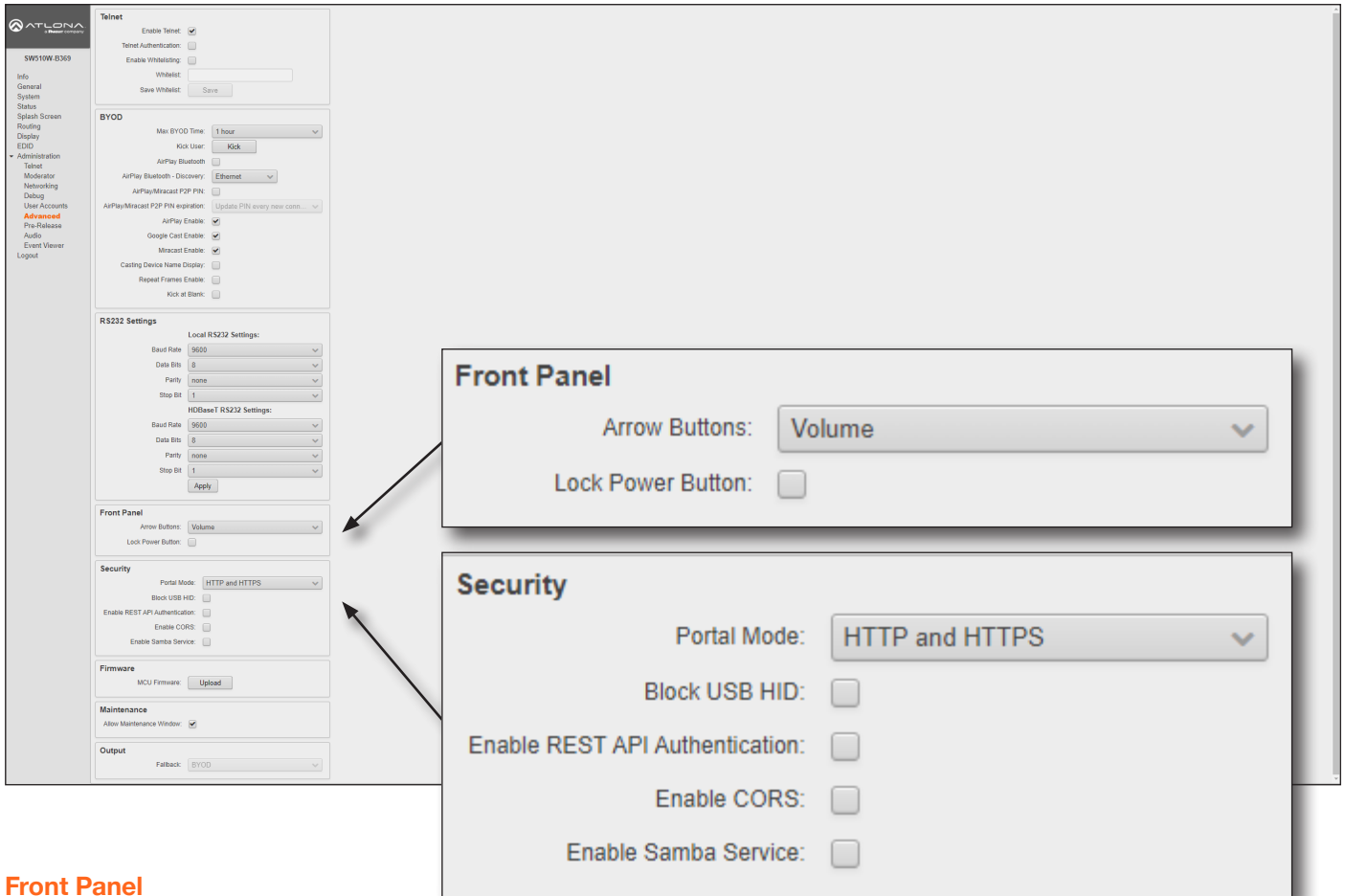

Front Panel

Lock Power Button

Check this box to enable or disable the locking of the **POWER** button on the front panel. Locking this button will prevent accidental pressing of the **POWER** button and powering-off the unit.

Security

Portal Mode

Click this drop-down list to select the desired HTTP protocol.

Setting	Description
HTTP and HTTPS	Provides either HTTP or HTTPS connections at the login screen.
HTTPS	Used for secure connections only.

Block USB HID

Deactivates / disables the USB ports on the rear panel of the AT-UHD-SW510W.

Enable REST API Authentication

Enables or disables REST authentication when using the AT-UHD-SW510W API. Click this check box to enable the feature.

Enable CORS

Check this box to enable Cross-Origin Resource Sharing (CORS). This allows the AT-UHD-SW510W to connect with certain servers. CORS is a method which allows restricted resources on a web page to be requested from another domain. Resources can include stylesheets (CSS), scripts, and other embedded elements.

Enable Samba Service

Check this box to enable file and print services for various Microsoft Windows clients using Samba.

Configuration and Management Interfaces

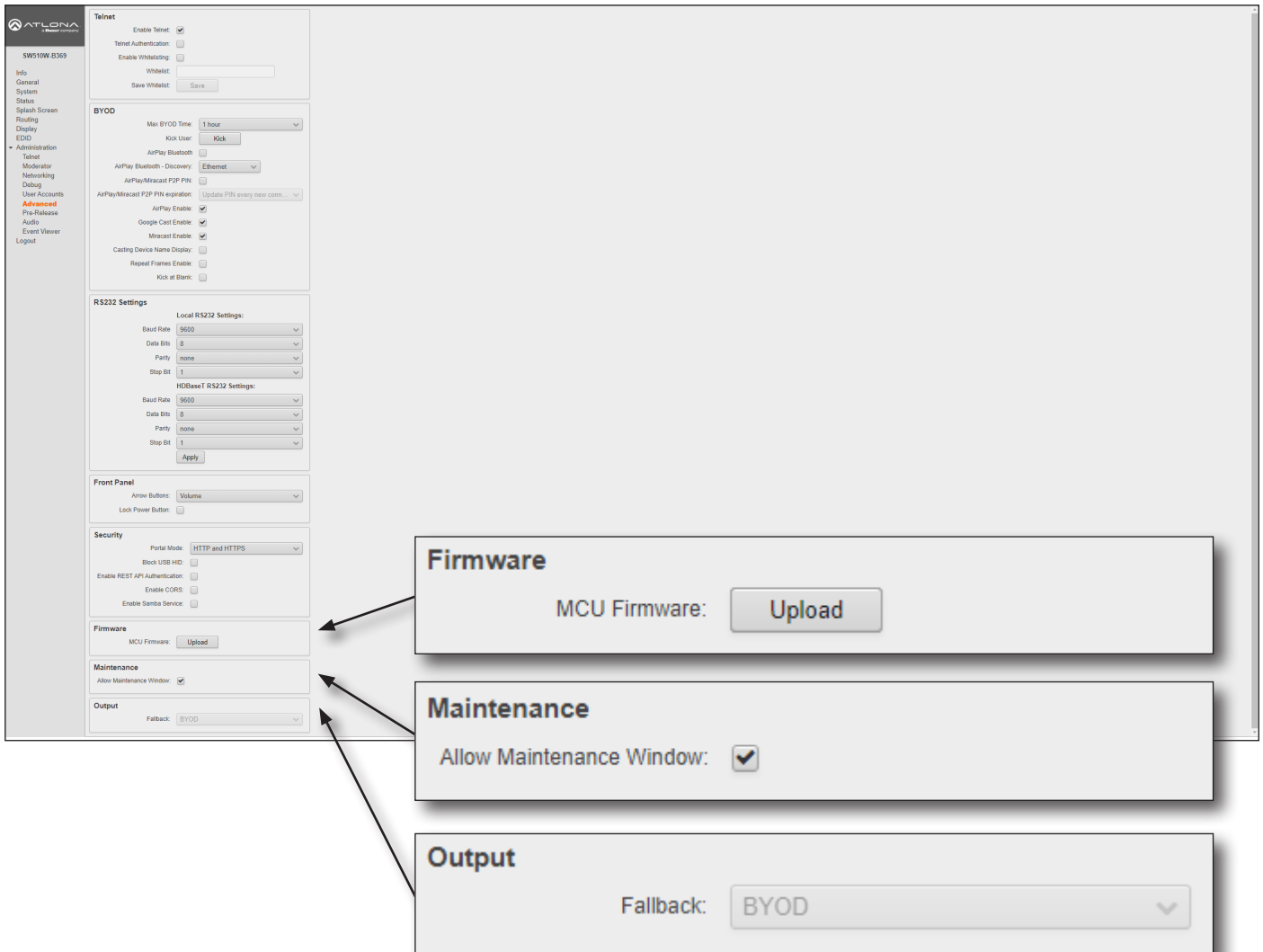

The screenshot shows the configuration interface for the AT-510W R369 device. The left sidebar contains a navigation menu with categories like Info, General, System, Status, and Administration. The main content area is divided into several sections: Teletnet, BYOD, RS232 Settings, Front Panel, Security, Firmware, Maintenance, and Output. Three callout boxes are overlaid on the right side of the interface:

- Firmware:** Points to the 'MCU Firmware: Upload' button in the Firmware section.
- Maintenance:** Points to the 'Allow Maintenance Window: checkbox in the Maintenance section.
- Output:** Points to the 'Fallback: BYOD' dropdown menu in the Output section.

Firmware

Upload

Click this button to upload the latest MCU firmware to the unit. Refer to [Updating the Firmware \(page 110\)](#) for more information.

Maintenance

Allow Maintenance Window

Check this box to enable maintenance mode. This feature can only be enabled if the local time has been set. Refer to [Setting the System Date and Time \(page 22\)](#) for more information. When enabled, the system will automatically restart all of its processes at 3:30 AM, every day.

Output

Fallback

This bypasses the default behavior of the system to fallback to the BYOD splash screen. If no video is detected, the AT-UHD-SW-510W immediately mutes the output instead of falling back to the splash screen.

Configuration and Management Interfaces

Administration > Pre-Release page

This page lists beta features, which are currently in the pre-release / testing stage. It should be noted that these features may not function reliably.

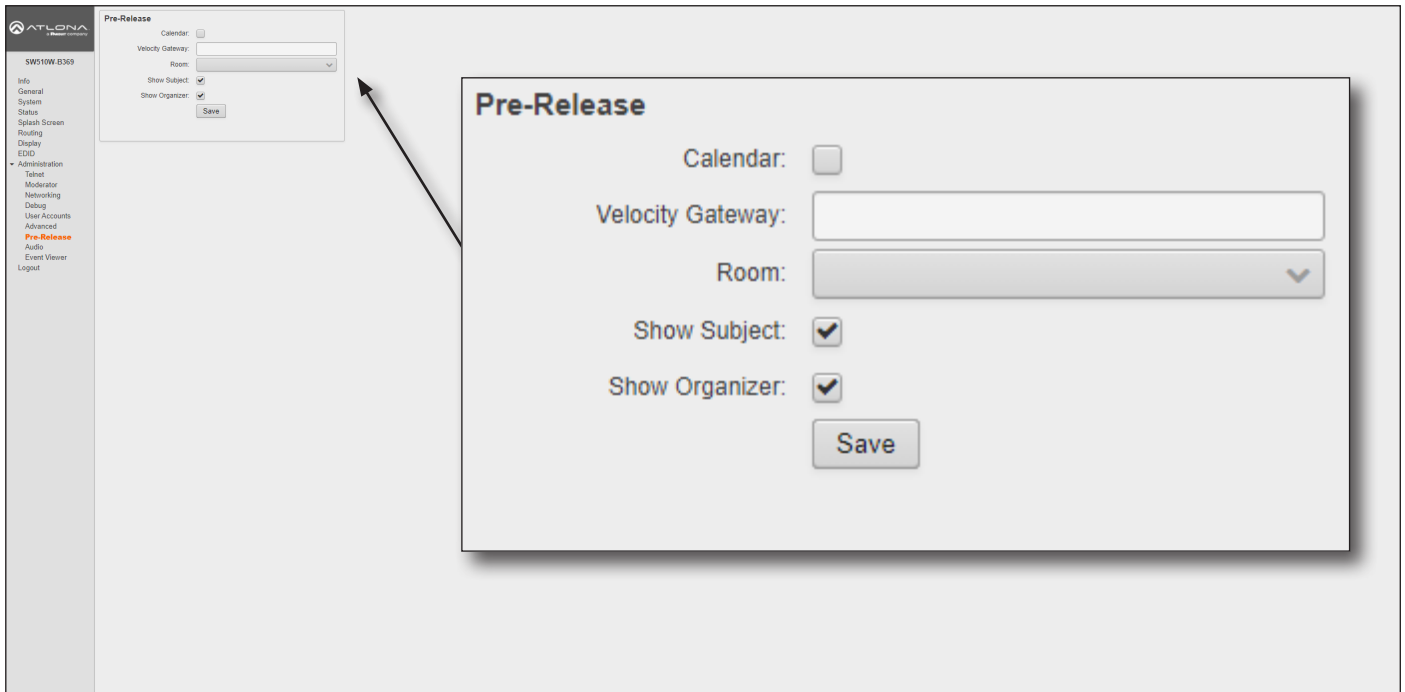

Pre-Release

Features listed under this window group can change between versions. As these features are not officially released, they are not documented.

Configuration and Management Interfaces

Administration > Audio page

This page provides control over the audio output level, as well as selecting analog or digital audio sources for each input.

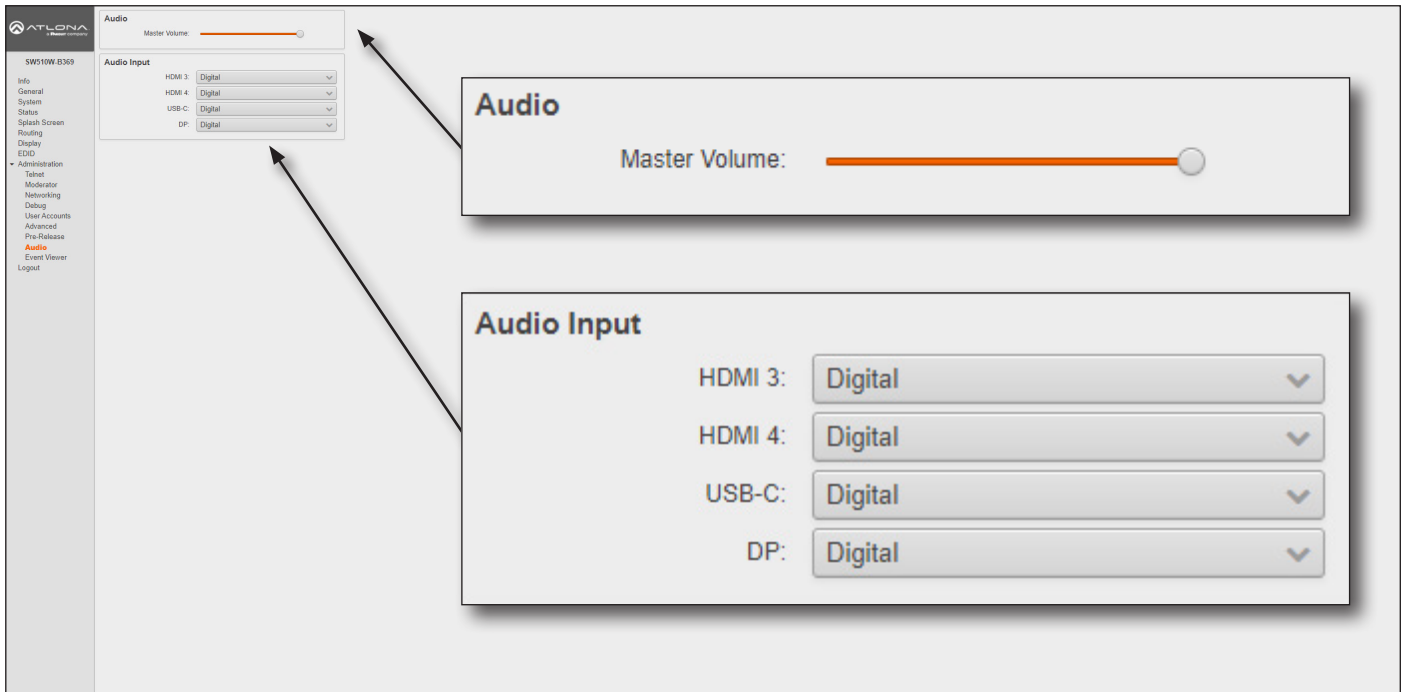

Audio

Master Volume

Click and drag this slider to adjust the output volume. Output is adjustable from -80 to 0 dB.

Audio Input

HDMI 3, HDMI 4, USB-C, DP

Click these drop-down lists to select the desired audio input source. If **Analog** is selected, then the analog audio source, connected to the 3.5 mm **AUDIO IN** port, will be heard on that output. Refer to [Audio Management \(page 57\)](#) for more information.

Configuration and Management Interfaces

Administration > Event Viewer page

This page displays a dynamic list of events, returned in JSON format. The image below, shows a list of sample events. This page is useful for monitoring events and troubleshooting the AT-UHD-SW-510W.

The screenshot shows the ATLONA Event Viewer interface. On the left is a navigation menu with categories like Info, General, System, Status, Splash Screen, Routing, Display, EDID, Administration, Telet, Moderator, Networking, Debug, User Accounts, Advanced, Pts-Release, and Audio. The main area displays a list of events, each with a timestamp and a JSON object describing the event. A callout box highlights a sample event:

```

[126 - 1606156704704] : {"event": "mcuCommand", "wait": false, "cmd": "RelayAct close"}
[127 - 1606156704955] : {"event": "log", "line": "Initializing Active Source: \n &{ID}input byod State false Name: VideoFormat: LastUpdate:2020-11-23 18:25:45.479088 +0000 UTC m:=+2919.076467001 InputCommand Input ODROID MatchInput 5 LEDCommand 4 on stateSync {r (state 0 sema 0) writerSem 0 readerSem 0 readerWait 0} lastUpdateSync {r (state 0 sema 0) writerSem 0 readerSem 0 readerCount 0 readerWait 0}"}
[128 - 1606156704961] : {"event": "log", "line": "Activating Media Source input byod"}
[129 - 1606156704967] : {"event": "mcuCommand", "wait": false, "cmd": "Input ODROID"}
[130 - 1606156705055] : {"event": "mcuCommand", "wait": false, "cmd": "SetLED 4 on"}
[131 - 1606156705155] : {"event": "mcuCommand", "wait": false, "cmd": "SetLED 5 on"}
[132 - 1606156705256] : {"event": "mcuCommand", "wait": false, "cmd": "SetPowerLED blue"}
[133 - 1606156705357] : {"event": "osdDelay", "activeSignals": {"signals": 0, "activehour": 4}}
[134 - 1606156705366] : {"event": "log", "line": "Display Powered On"}}
[135 - 1606156705374] : {"event": "log", "line": "Display Warming Up . . ."}}
[136 - 1606156713879] : {"event": "log", "line": "Display Done Cooling Down"}}
[137 - 1606156720357] : {"event": "log", "line": "Display Done Warming Up"}}
[138 - 1606156926483] : {"event": "mcuCommand", "wait": false, "cmd": "Version"}
  
```

Appendix

Updating the Firmware

The following procedure outlines the firmware update procedure for the AT-UHD-SW-510W. This product can only be updated through the web GUI.



WARNING: Do not physically reboot the system during the update process. Doing so may cause firmware file corruption and/or system instability.

Requirements:

- AT-UHD-SW-510W
- Firmware file
- Computer on a network that can reach the network where AT-UHD-SW-510W is connected

Updating from Version 2.0.0 or later



IMPORTANT: This section applies *ONLY* to upgrading from version 2.0.0 or later. The AT-UHD-SW-510W **must** be running Master Firmware version 2.0.0 in order to upgrade to the latest version.

If the AT-UHD-SW-510W is running an earlier version of firmware, then refer to **Updating from 1.2.1-5 or earlier**, on page 112, and complete that procedure before continuing.



IMPORTANT: Note that the firmware update cycle could take up to 10 minutes and the AT-UHD-SW-510W may reboot twice during update process.

1. Download the latest firmware from atlon.com and extract the contents of the .zip file to a folder on the computer.
2. Connect the computer, containing the firmware files, to the same network as the AT-UHD-SW-510W.
3. Press and release the **IP** button on the front panel. The IP address of the AT-UHD-SW-510W will appear on the connected display.



NOTE: If using hardware revision A or B, simultaneously press and hold the **INPUT** and **A** buttons on the front panel for five seconds, then release. The IP address will appear on the connected display. The hardware revision can be found on the label, on the bottom of the unit.

4. Launch a web browser and enter the IP address of the AT-UHD-SW-510W in the address bar.
5. The **Login** screen will be displayed. Enter the login credentials.
6. Click **System** on the side menu bar.
7. Click the **Upload** button and select the `SW510_MS52W-[version].bin` file. Refer to the illustration on the next page.
8. During the update process, the following message will appear in the upper-right corner of the screen. Note that the update process may take **up to five minutes to complete**. The unit will automatically reboot as part of the update process.

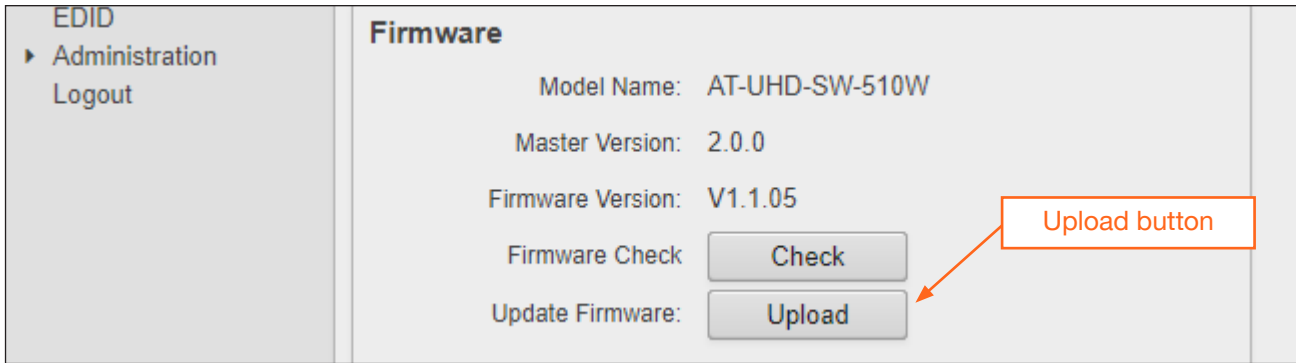

9. After the firmware process has completed, the AT-UHD-SW-510W will automatically reboot and the following message will appear at the top of the screen:

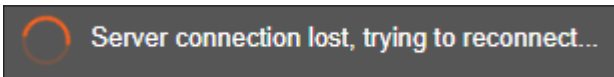

IMPORTANT: If the “Please Reboot Me” message appears on the connected display, then the AT-UHD-SW-510W must be power-cycled.

10. Click the message or press the ESC key to return to the **Login** screen. Enter the login credentials.

Communication problem Take note of any unsaved data, and click here or press ESC to continue.

11. The firmware update is complete.

Updating from Version 1.2.1-5 (or earlier)

1. Download the firmware file from the Atlona product page.
2. Connect the computer, containing the firmware files, to the same network as the AT-UHD-SW-510W.
3. Press and release the IP button on the front panel. The IP address will appear on the connected display.

 **NOTE:** If using hardware revision A or B, simultaneously press and hold the **INPUT** and **A** buttons on the front panel for five seconds, then release. The IP address will appear on the connected display.

4. Launch a web browser and enter the IP address of the AT-UHD-SW-510W in the address bar.
5. The **Login** screen will be displayed. Enter the login credentials. The default username and password are listed below:
6. Click **System** on the side menu bar.
7. Click the **Upload** button next to **Master Firmware** and select the `SW-510W_MASTER_2.0.0-A.war` file.

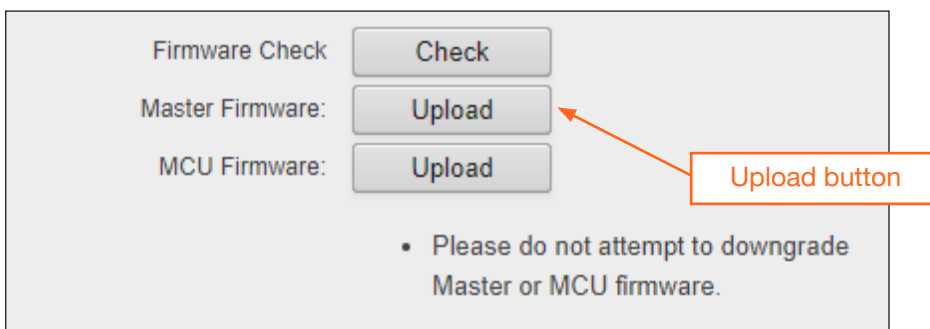

 **WARNING:** Do not physically reboot the system during the update process. Doing so may cause firmware file corruption and/or system instability.

8. During the update process, the following message will appear in the upper-right corner of the screen. Note that the update process may take **up to five minutes to complete**. The unit automatically reboots.

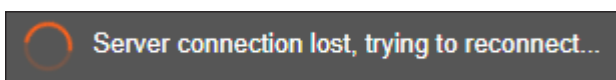

 **NOTE:** Depending upon the currently-loaded firmware, a “hard reboot” may be required in order to reestablish communication with the webGUI. To perform a hard reboot, disconnect the power cord, wait 10 seconds, then reconnect the power.

9. The following message will appear at the top of the screen. Click the message or press the ESC key to return to the **Login** screen. Enter the login credentials.

Communication problem Take note of any unsaved data, and click here or press ESC to continue.

10. Click **Info** on the side menu bar and check the **Firmware Version**.

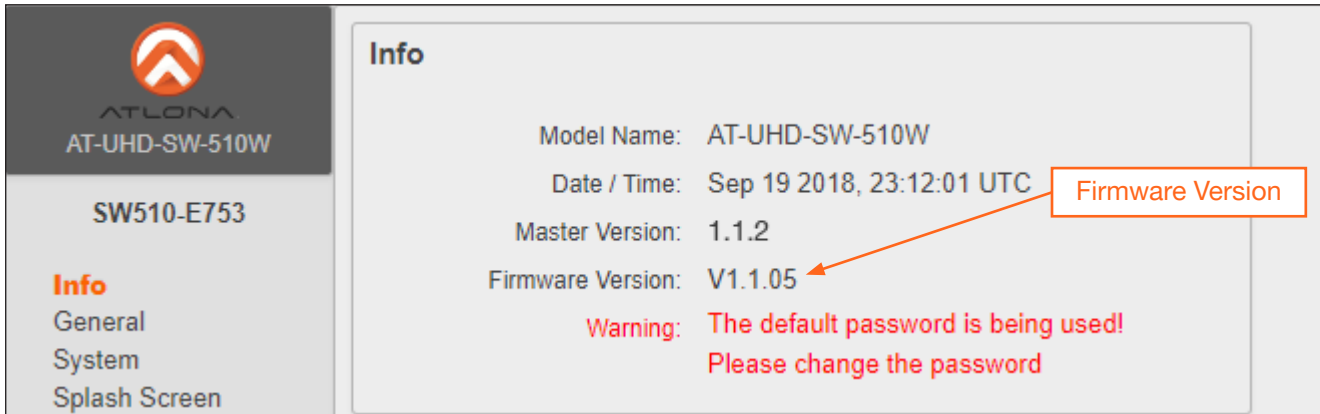

Info

Model Name: AT-UHD-SW-510W
 Date / Time: Sep 19 2018, 23:12:01 UTC
 Master Version: 1.1.2
 Firmware Version: V1.1.05

Warning: The default password is being used!
 Please change the password

- If the Firmware Version reads **1.1.05**, then the firmware update process is complete. No additional steps are required.
- If the Firmware Version is an *earlier* firmware, then continue with Step 11.

11. Click **System** on the side menu bar.

12. Click the **Upload** button, next to **Update Firmware** and select the SW510_MS52W-[version].bin file.

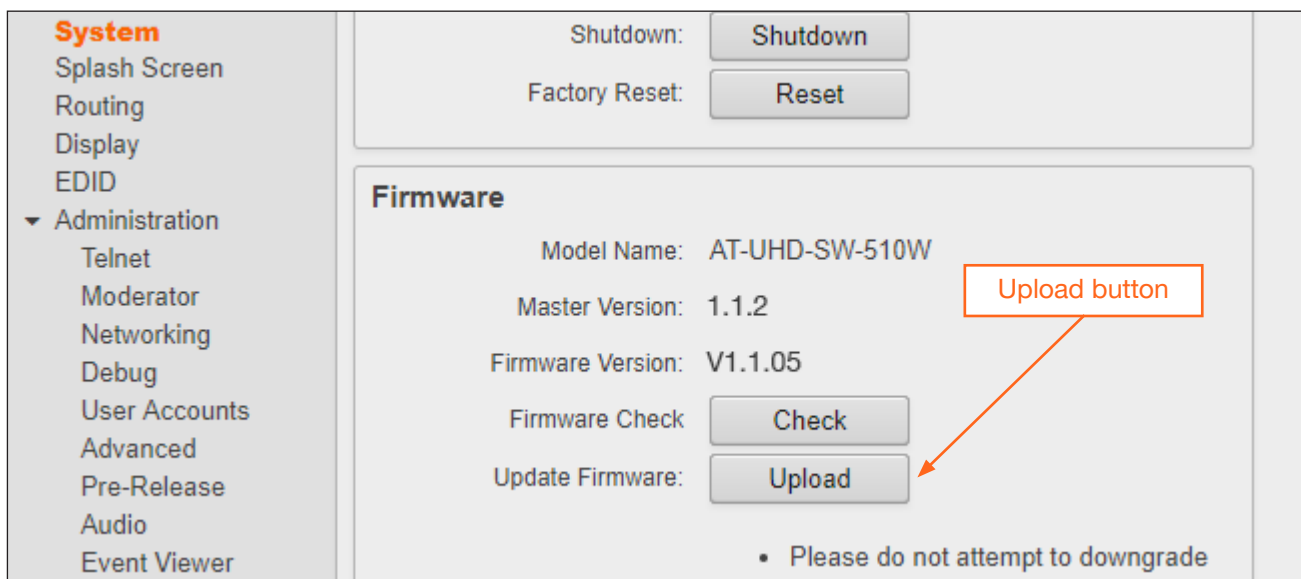

System

Shutdown:
 Factory Reset:

Firmware

Model Name: AT-UHD-SW-510W
 Master Version: 1.1.2
 Firmware Version: V1.1.05

Firmware Check:
 Update Firmware:

• Please do not attempt to downgrade



WARNING: Do not physically reboot the system during the update process. Doing so may cause firmware file corruption and/or system instability.

13. During the update process, the following message will appear in the upper-right corner of the screen. Note that the update process may take **up to five minutes to complete**. The unit automatically reboots.

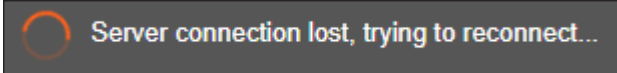

14. After the firmware process has completed, the AT-UHD-SW-510W will automatically reboot and the following message will appear at the top of the screen:

Communication problem Take note of any unsaved data, and click here or press ESC to continue.

15. Click the message or press the ESC key to return to the **Login** screen. Enter the login credentials.
16. Click **Info** on the side menu bar and check the presence of the **Firmware Version** section. It should read V1.1.05.

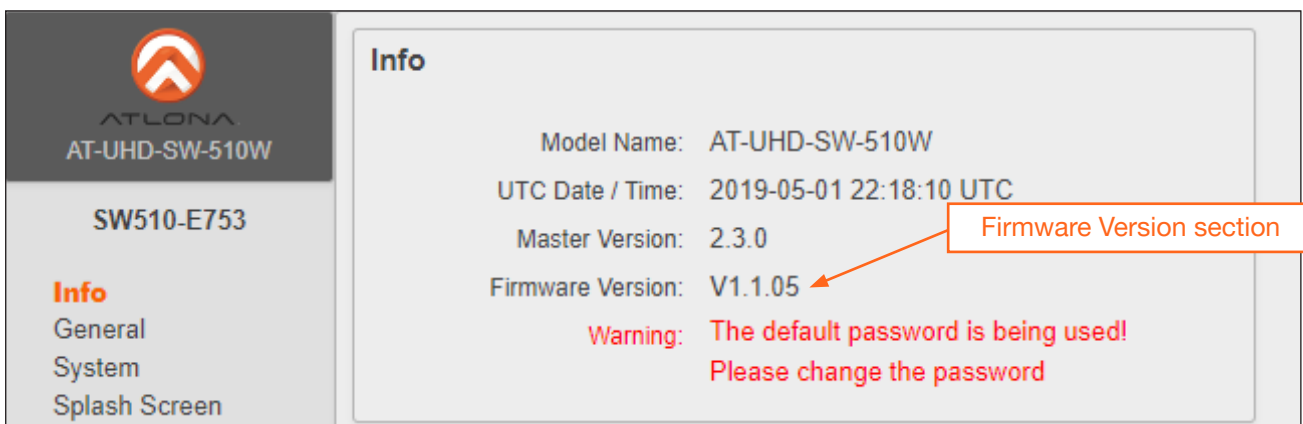

17. If there is no **Firmware Version** section, then do the following:
- Click **System** on the side menu bar.
 - Click the **Shutdown** button.
 - Wait one minute, then power-on the unit.

18. The firmware update process is complete.

Mounting Instructions

The AT-UHD-SW-510W can be mounted in different ways, based on the number of units that are being installed. The AT-UHD-SW-510W can be mounted in a rack or on/under any flat surface.



NOTE: Rack ears (Altona part no. AT-UHD-SW-510W-RM) are sold separately. Contact Atlona for more information.

Single-unit Rack Installation

1. Attach the included small rack ear (sold separately) to one side of the AT-UHD-SW-510W, using the included screws.
2. Attach the included longer rack ear (sold separately) to the opposite side of the AT-UHD-SW-510W using the included screws.



Dual-unit Rack Installation

1. Turn both units upside-down on a flat surface, next to each other, as shown.
2. Position the included mounting plates over the holes on the bottom of the enclosure.
When attaching mounting plates, the countersink bevels on the mounting plate should face upward.

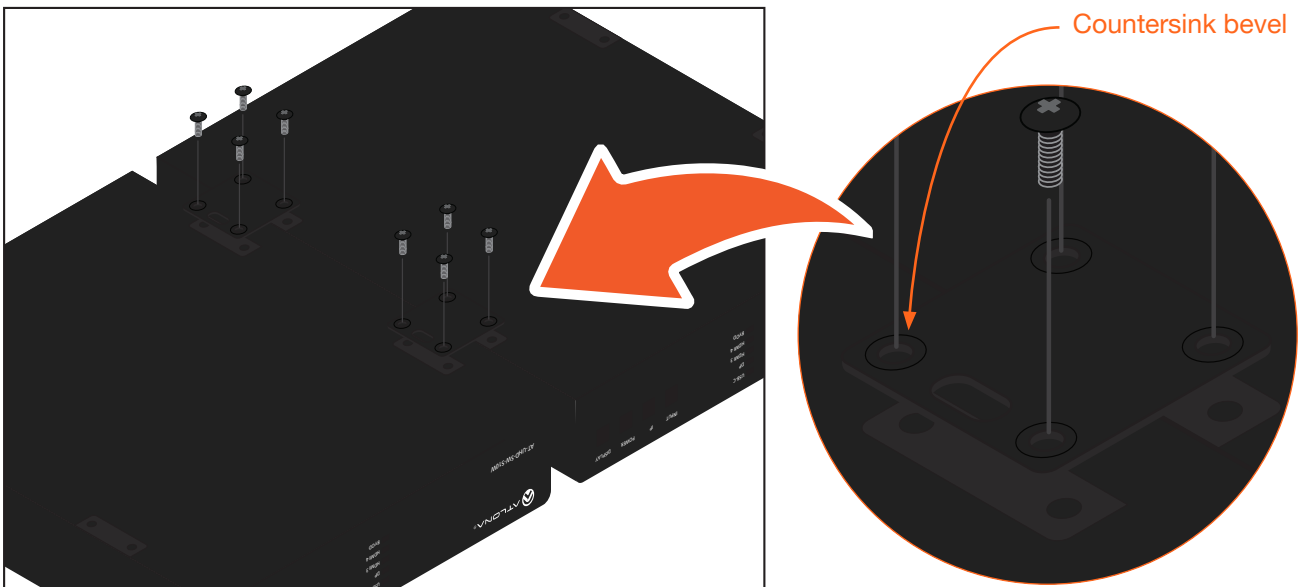

3. Turn the attached units over and install the rack ears (sold separately) to one side of each enclosure using the included screws.



Flat Surface

1. Turn the unit upside down, on a flat surface.
2. Position the included mounting plates over the pre-drilled holes on the bottom of the enclosure. When attaching mounting plates, the countersink bevels on the mounting plates should face upward.

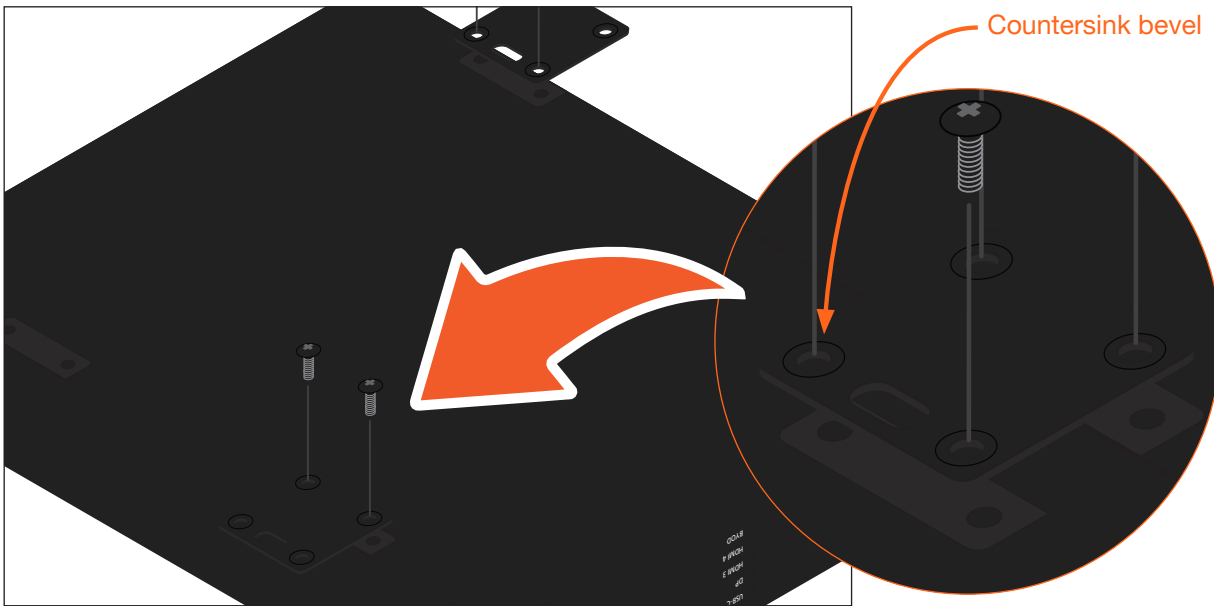

3. Mount the unit using the circular holes, on each mounting plate. If using a drywall surface, a #6 drywall screw is recommended. Mounting screws are not included.



NOTE: The unit can also be mounted under a flat surface, such as a table, by turning the unit upside down.

Specifications

Video		
HDMI	2.0 ⁽¹⁾	
HDCP	2.2 (wired-device connections, only)	
UHD/HD	4096×2160 @ 60 ⁽²⁾ /50/30/25/24 Hz 3840×2160 @ 60 ⁽²⁾ /50/30/25/24 Hz 1920×1080p @ 60/59.9/50/30/29.97/25/24/23.98 Hz 1920×1080i @ 30/29.97/25 Hz	1280×720p @ 60/59.94/50 Hz 720×576p @ 50 Hz 720×576i @ 50 Hz 640×480p @ 60/59.96 Hz 640×480i @ 30 Hz
VESA All resolutions are 60 Hz	2560×1600 2048×1536 1920×1200 1680×1050 1600×1200 1440×900 1400×1050 1280×1024	1280×800 1366×768 1360×768 1152×864 1024×768 800×600 640×480
USB-C ⁽³⁾	Up to 4K/UHD @ 60 Hz for devices supporting USB-C Alternate Mode video output	
Wireless	Up to 1080p @ 30 Hz 4:2:0 (up to 1080p @ 60 Hz with Miracast™); dependent on wireless signal quality	
Color Space	YUV, RGB	
Chroma Subsampling	4:4:4, 4:2:2, 4:2:0	
Color Depth	8-bit, 10-bit, 12-bit	
HDR ⁽⁴⁾	HDR10, Hybrid-Log Gamma (HLG), and Dolby® Vision™ @ 60 Hz	

Audio			
HDMI / HDBaseT Pass-Through Formats	LPCM 2.0	Dolby® Digital Dolby Digital Plus™ Dolby TrueHD Dolby Atmos®	DTS® Digital Surround™ DTS-HD Master Audio™ DTS:X®
Bit Rate	24 Mbits/s max		
Analog Audio			
Format	2-channel stereo		
Balanced Output	+4 dBu, nominal gain; +20 dBu headroom		
Frequency Response	20 Hz to 20 kHz, ±0.5 dB		
THD + N	< 0.009% @ 20 Hz to 20 kHz		
SNR	> 94 dB @ 1 kHz, zero clipping @ 0 dBFS, unweighted		
Sample Rate	32 kHz, 44.1 kHz, 48 kHz, 88.2 kHz, 96 kHz, 176.4 kHz, 192 kHz		

USB	
Signal	2.0
Maximum Data Rate	120 Mbps
USB-C	Supports Audio, Video, device and host data, and up to 60W power charging
USB-C Device Charging Capability	Up to 20 V, 3 A Output: 60 W @ 20 V, 36 W @ 12 V, 15 W @ 5 V

Protocols	
Addressing	DHCP, static
Security	HTTPS, SSL, TLS
Authentication	IEEE 802.1x
Wi-Fi	IEEE 802.11n/ac 2.4 GHz / 5 GHz
Wi-Fi Security	WPA, WPA2, PSK

Control	
RS-232	Device control and configuration; supports baud rates from 2400 to 115200 Bidirectional pass-through from control system to network
TRIGGER	Occupancy sensor triggering; wake from standby and/or display power-up when room becomes occupied.
RELAY	Contact closure control for room functions such as motorized screens and display lifts, as well as occupancy sensing and remote button controls.

Resolution / Distance	4K/UHD - Feet / Meters		1080p - Feet / Meters	
HDMI IN/OUT	15	5	30	10
CAT5e	230	70	330	100
CAT6/6a/7	330	100	330	100

Connectors	
HDMI IN	2 - Type A, 19-pin female
HDMI OUT	1 - Type A, 19-pin female
DP IN	1 - 20-pin female
USB-C IN	1 - USB Type-C v3.1, 24-pin female, AV input (Alternate Mode)
USB	3 - USB 2.0 Type A for Wi-Fi® antenna modules
RS-232	1 - 3-pin captive screw (bidirectional)
RELAY	1 - 3-pin captive screw, normally open (NO), with adjustable Toggle and Pulse modes; Electrical rating: 48 V @ 1 A
TRIGGER	1 - 4-pin captive screw, supports 3 - 30 V DC input range, power supply is 12 V @ 100 mA max.
AUDIO IN	1 - 3.5 mm, unbalanced 2-channel
AUDIO OUT	1 - 5-pin captive screw, balanced / unbalanced 2-channel
HDBaseT OUT	1 - RJ45
LAN	1 - RJ45, 10/100/1000 Mbps
DC 24V	1 - 4-pin DIN, locking

Indicators and controls	
USB-C	1 - LED, blue
DP	1 - LED, blue
HDMI 3	1 - LED, blue
HDMI 4	1 - LED, blue
BYOD	1 - LED, blue
Control Buttons	4 - momentary, tact-type INPUT: Switches between inputs IP: Displays the IP address of the unit on the connected display POWER: Power-off the unit DISPLAY: Power-on / power-off the connected display

Environmental	
Operating Temperature	+32 to +122 °F 0 to +50 °C
Storage Temperature	-4 to +140 °F -20 to +60 °C
Operating Humidity (RH)	20% to 95%, non-condensing

Power	
Consumption (full load)	121 W
Idle Consumption	35 - 40 W
Supply	Input: 100 - 240 V AC, 50/60 Hz Output: 24 V / 5 A DC

Dimensions (H x W x D)	Inches	Millimeters
Unit	1.73 x 8.46 x 10.19	44 x 215 x 259
Power Supply (AT-PS-48208-D3) ⁽⁵⁾	1.6 x 2.6 x 6.2	40.6 x 66 x 157.4

Weight	Pounds	Kilograms
Device	3.70	1.68

Certification	
Device	CE, RoHS, FCC

(1) 18 Gbps supported for HDMI 2.0 output. HDBaseT output limited to 10 Gbps.

(2) HDMI output supports 4K/UHD @ 50 or 60Hz with 4:4:4 chroma sampling. HDBaseT output supports 4K/UHD @ 50 or 60Hz with 4:2:0 chroma subsampling.

(3) USB-C does not support the following input resolutions: 2560x2048, 2048x1536, 2028x1080, and 1440x1050.

(4) HDR not supported on HDBaseT output.

(5) Revision A hardware uses AT-PS-245-C power supply. Revision B hardware uses AT-PS-245-D4 power supply. Power supply dimensions are the same.

