

4K / HDR Five-Input HDMI Switcher



Version Information

Version	Release Date	Notes
3	Jan 2024	Updated warranty information

Sales, Marketing, and Customer Support

Main Office

Atlona Incorporated
70 Daggett Drive
San Jose, CA 95134
United States

Office: +1.408.962.0515

Sales and Customer Service Hours
Monday - Friday: 6:00 a.m. - 4:30 p.m. (PST)

<https://atlona.com/>

International Headquarters

Atlona International AG
Tödistrasse 18
8002 Zürich
Switzerland

Office: +41.43.508.4321

Sales and Customer Service Hours
Monday - Friday: 09:00 - 17:00 (UTC +1)

Operating Notes



IMPORTANT: Visit <https://www.atlona.com/product/at-hdr-sw-51> for the latest firmware updates and User Manual.

Warranty



To view the product warranty, use the following link or QR code:

<https://atlona.com/warranty/>.

Safety and Certification



CAUTION: TO REDUCE THE RISK OF ELECTRIC SHOCK DO NOT OPEN ENCLOSURE OR EXPOSE TO RAIN OR MOISTURE. NO USER-SERVICEABLE PARTS INSIDE REFER SERVICING TO QUALIFIED SERVICE PERSONNEL.



The exclamation point within an equilateral triangle is intended to alert the user to the presence of important operating and maintenance instructions in the literature accompanying the product.



The information bubble is intended to alert the user to helpful or optional operational instructions in the literature accompanying the product.

1. Read these instructions.
2. Keep these instructions.
3. Heed all warnings.
4. Follow all instructions.
5. Do not use this product near water.
6. Clean only with a dry cloth.
7. Do not block any ventilation openings. Install in accordance with the manufacturer's instructions.
8. Do not install or place this product near any heat sources such as radiators, heat registers, stoves, or other apparatus (including amplifiers) that produce heat.
9. Do not defeat the safety purpose of a polarized or grounding-type plug. A polarized plug has two blades with one wider than the other. A grounding type plug has two blades and a third grounding prong. The wide blade or the third prong are provided for your safety. If the provided plug does not fit into your outlet, consult an electrician for replacement of the obsolete outlet.
10. Protect the power cord from being walked on or pinched particularly at plugs, convenience receptacles, and the point where they exit from the product.
11. Only use attachments/accessories specified by Atlona.
12. To reduce the risk of electric shock and/or damage to this product, never handle or touch this unit or power cord if your hands are wet or damp. Do not expose this product to rain or moisture.
13. Unplug this product during lightning storms or when unused for long periods of time.
14. Refer all servicing to qualified service personnel. Servicing is required when the product has been damaged in any way, such as power-supply cord or plug is damaged, liquid has been spilled or objects have fallen into the product, the product has been exposed to rain or moisture, does not operate normally, or has been dropped.



FCC Compliance

FCC Compliance and Advisory Statement: This hardware device complies with Part 15 of the FCC rules. Operation is subject to the following two conditions: 1) this device may not cause harmful interference, and 2) this device must accept any interference received including interference that may cause undesired operation. This equipment has been tested and found to comply with the limits for a Class A digital device, pursuant to Part 15 of the FCC Rules. These limits are designed to provide reasonable protection against harmful interference in a commercial installation. This equipment generates, uses, and can radiate radio frequency energy and, if not installed or used in accordance with the instructions, may cause harmful interference to radio communications. However there is no guarantee that interference will not occur in a particular installation. If this equipment does cause harmful interference to radio or television reception, which can be determined by turning the equipment off and on, the user is encouraged to try to correct the interference by one or more of the following measures: 1) reorient or relocate the receiving antenna; 2) increase the separation between the equipment and the receiver; 3) connect the equipment to an outlet on a circuit different from that to which the receiver is connected; 4) consult the dealer or an experienced radio/TV technician for help. Any changes or modifications not expressly approved by the party responsible for compliance could void the user's authority to operate the equipment. Where shielded interface cables have been provided with the product or specified additional components or accessories elsewhere defined to be used with the installation of the product, they must be used in order to ensure compliance with FCC regulations.

Copyright, Trademark, and Registration

© 2024 Atlona Inc. All rights reserved. "Atlona" and the Atlona logo are registered trademarks of Atlona Inc. Pricing, specifications and availability subject to change without notice. Actual products, product images, and online product images may vary from images shown here.

HDMI™ The terms HDMI, HDMI High-Definition Multimedia Interface, HDMI trade dress and the HDMI Logos are trademarks or registered trademarks of HDMI Licensing Administrator, Inc.

Dolby, Dolby Atmos, and the double-D symbol are registered trademarks of Dolby Laboratories Licensing Corporation.

For DTS patents, see <http://patents.dts.com>. Manufactured under license from DTS, Inc. DTS, the Symbol, DTS and the Symbol together, and Digital Surround are registered trademarks and/or trademarks of DTS, Inc. in the United States and/or other countries. © DTS, Inc. All Rights Reserved.

All other trademark(s), copyright(s), and registered technologies mentioned(s) in this document are the properties of their respective owner(s).

Table of Contents

Introduction	7
Features	7
Package Contents	7
Panel Description	8
Front Panel	8
Rear Panel	9
Installation	10
Power	10
Connection Instructions	10
Connection Diagram	11
IP Configuration	12
Using the Front Panel	12
Using the Web Server	13
Setting the IP Address Using Commands	13
Automatic Private IP Addressing (APIPA) Mode	14
Device Operation	15
LED Indicators	15
Logging in to the Web Server	16
Login Registration	16
Logging in after Registration	17
Selecting the Input	18
Using the Web Server	18
Using the Front Panel	18
Auto Switching	19
Enabling / Disabling Auto Switching	19
Scaler Pass-Through	20
Notes on Scaling	21
Audio Management	22
HDMI Audio Muting	22
Analog Audio Output	23
S/PDIF Audio Muting	24
HDCP Content	25
RS-232 Control	26
EDID Management	27
Using the Downstream EDID	27
EDID Presets	28
Storing EDID Data	29
User Management	32
System Configuration	33
Getting the MAC Address	33
Changing the Network IP Mode	33
Changing the Telnet Port	34
Telnet Login Mode	35
Telnet Timeout	35
Broadcast	36
Setting the Host Name	36
Locking / Unlocking the Front Panel	37
Resetting to Factory Defaults	38
Using the Web Server	38
Using the Front Panel	39

Table of Contents

Configuration and Management Interfaces	40
Web Server	40
Register page	40
Login page	41
Info page	42
A/V Settings page	43
RS-232 page	45
EDID page	46
Config page	47
System page	48
Appendix	50
Updating the Firmware	50
Using the Web Server	50
Using USB	51
Mounting Instructions	52
Single Unit Rack Installation	52
Dual Unit Rack Installation	53
Flat Surface	54
Specifications	55

Introduction

The Atlona **AT-HDR-SW-51** is a 5x1 HDMI switcher for high dynamic range (HDR) formats. Part of the comprehensive family of Atlona 4K HDR integration products, it features five HDMI inputs and an HDMI output. The HDR-SW-51 is HDCP 2.2 compliant and supports 4K/UHD video @ 60 Hz with 4:4:4 chroma sampling, as well as HDMI data rates up to 18 Gbps. It is ideal for the latest as well as emerging 4K/UHD and HDR sources and displays, and includes EDID management features and automatic input switching. Additionally, 4K downscaling to 1080p @ 60, 30, or 24 Hz is available when connected to an HD display. The HDR-SW-51 can de-embed audio from an HDMI input to S/PDIF or analog audio outputs. This HDMI switcher can be controlled via Ethernet, RS-232, and IR.

Features

- 5x1 HDMI switcher
- Selectable 4K to 1080p downscaling
- Automatic input selection using hot plug detect and video detection technology
- Audio de-embedding
- TCP/IP, RS-232, and IR control

Package Contents

1 x AT-HDR-SW-51
1 x Captive screw connector, 2-pin
1 x Captive screw connector, 3-pin
2 x Mounting plates
4 x Mounting screws
4 x Rack screws
1 x Long rack ear
1 x Short rack ear
4 x Feet w/rubber grips
1 x 5 V / 4 A DC power supply

Panel Description

Front Panel

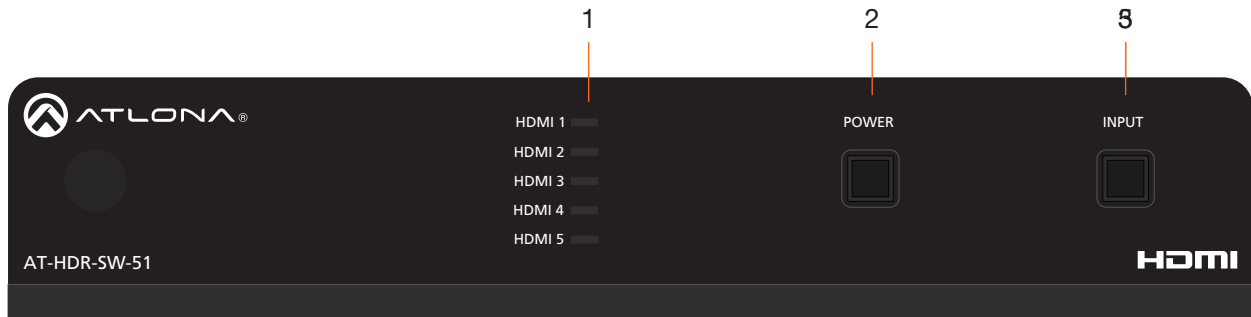

1 HDMI 1 - HDMI 5: Input LED Indicators

These LED indicators display which input is routed to the **HDMI OUT** port. A solid blue indicator represents the active input being used

2 POWER

Press this button to toggle between “on” and “standby” power states. When in “standby”, A/V is muted. When “on”, A/V muting will be disabled.

3 INPUT

Press and release this button to cycle through each of the HDMI inputs.

Rear Panel

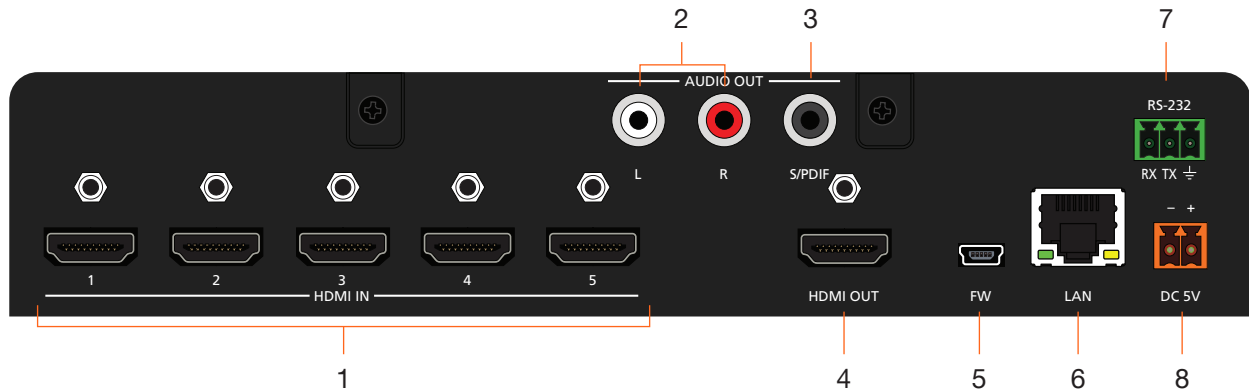

- 1 HDMI IN**
Connect an HDMI cable from each of these ports to an HDMI source.
- 2 L/R**
Connect two RCA-type cables from these ports to an analog audio output device.
- 3 S/PDIF**
Connect an RCA-type cable from this port to the S/PDIF audio input port on an A/V receiver or other audio output device.
- 4 HDMI OUT**
Connect an HDMI cable from each of these ports to an HDMI display.
- 5 FW**
Connect a USB-to-mini USB cable to this port from a computer for firmware updates.
- 6 LAN**
Connect an Ethernet cable from this port to the Local Area Network (LAN). The AT-HDR-SW-51 includes a built-in web server, which can be used to manage and configure the product.
- 7 RS-232**
Connect the included captive screw block to an RS-232 controller to control the AT-HDR-SW-51.
- 8 DC 5V**
Connect the included 5 V DC power supply from this power receptacle to an available AC electrical outlet. Refer to [Power \(page 10\)](#) for more information on wiring the included captive screw connector.

Installation

Power

Connect the included 2-pin captive screw connector to the **DC 5V** power receptacle on the rear of the unit. The captive screw comes pre-wired as shown

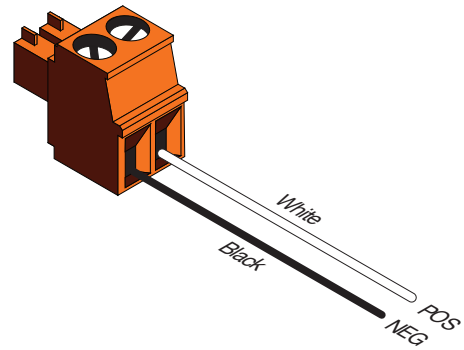
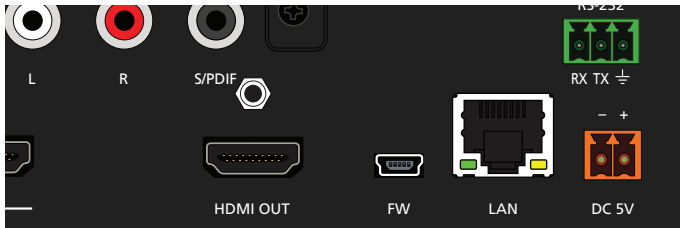

Connection Instructions

1. Connect a source device to each of the **HDMI IN (1 - 5)** ports.
2. Connect a display device to the **HDMI OUT** port.
3. Connect an Ethernet cable from the **LAN** port to the Local Area Network (LAN). This step will be required in order to access the built-in web server.
4. Connect two RCA-type cables from these ports to an analog audio output device.
5. Connect an RCA-type cable from the **S/PDIF** port to an audio output device.
6. Connect an RS-232 cable from the control system to the **RS-232** port. Refer to [RS-232 Control \(page 26\)](#) for more information.
7. Connect the included power supply to the **DC 5V** connector and connect the power cord to an available electrical outlet.

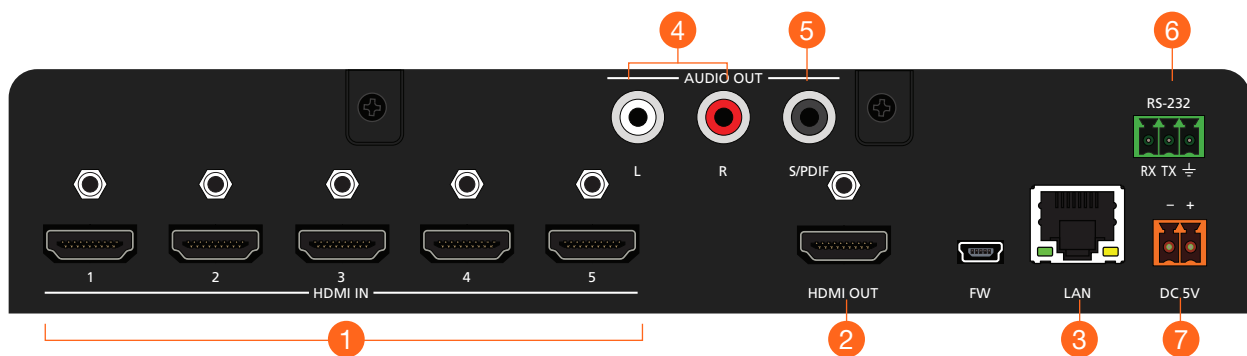

Connection Diagram

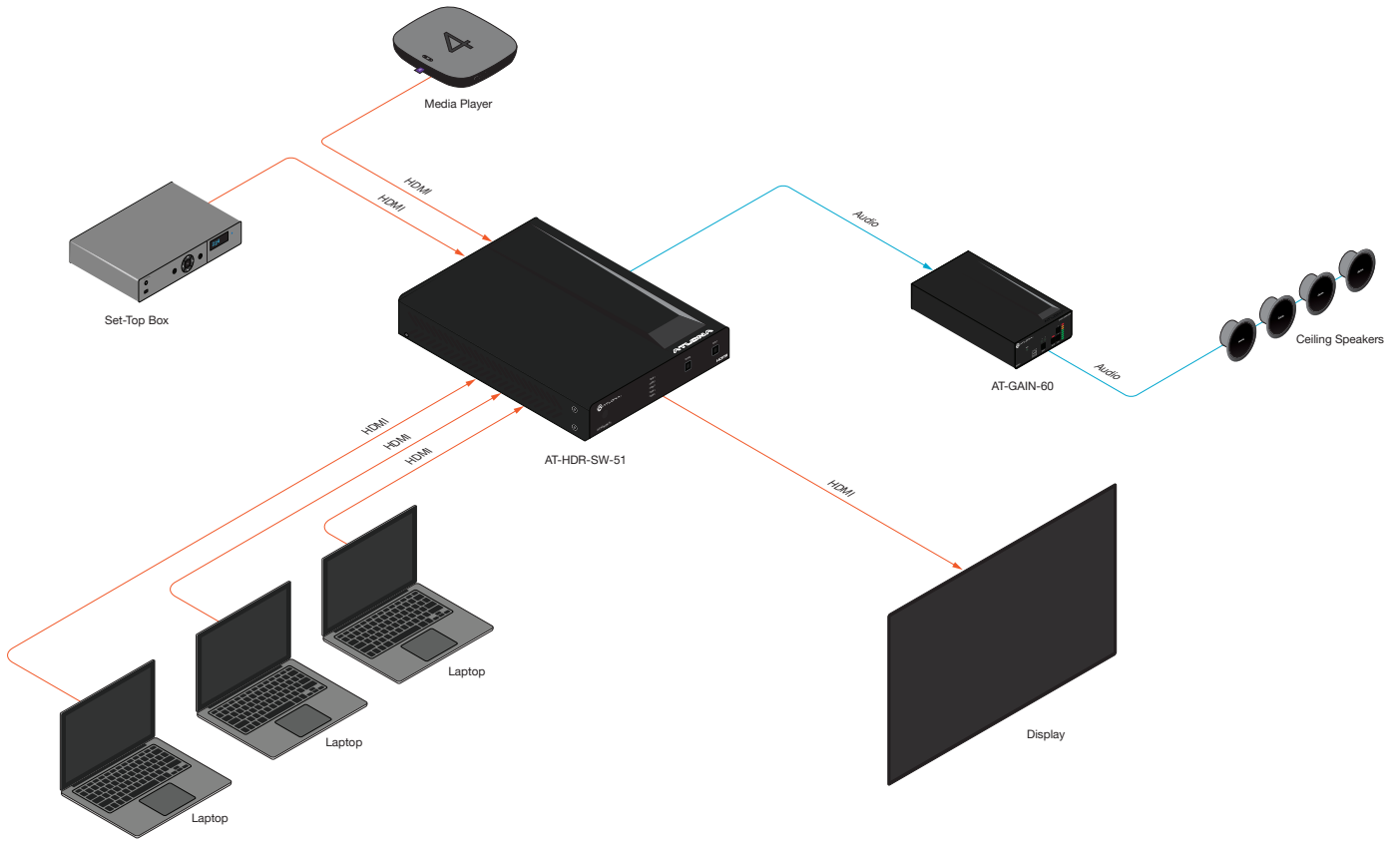

IP Configuration

The AT-HDR-SW-51 is shipped with DHCP enabled. Once connected to a network, the DHCP server (if available), will automatically assign an IP address to the unit. If the AT-HDR-SW-51 is unable to detect a DHCP server within 15 seconds, then the unit will use a self-assigned IP address within the range of 169.254.xxx.xxx/16. If this occurs, refer to [Automatic Private IP Addressing \(APIPA\) Mode](#) (page 14).

Use an IP scanner, along with the MAC address on the bottom of the unit, to identify the unit on the network. If a static IP address is desired, the unit can be switched to static IP mode.



NOTE: When switching between DHCP and static IP mode, the AT-HDR-SW-51 will retain the last assigned IP address until it is changed manually (static IP mode) or assigned a new IP address by the DHCP server.

Using the Front Panel

1. Make sure the AT-HDR-SW-51 is powered.
2. Connect an Ethernet cable between the **LAN** port of the AT-HDR-SW-51 and the Local Area Network (LAN).
3. Press and hold the **POWER** button for approximately 15 seconds. Release the **POWER** button once all the front-panel LED indicators begin to flash. The number of flashes will indicate the currently selected IP mode. Refer to the table, below.

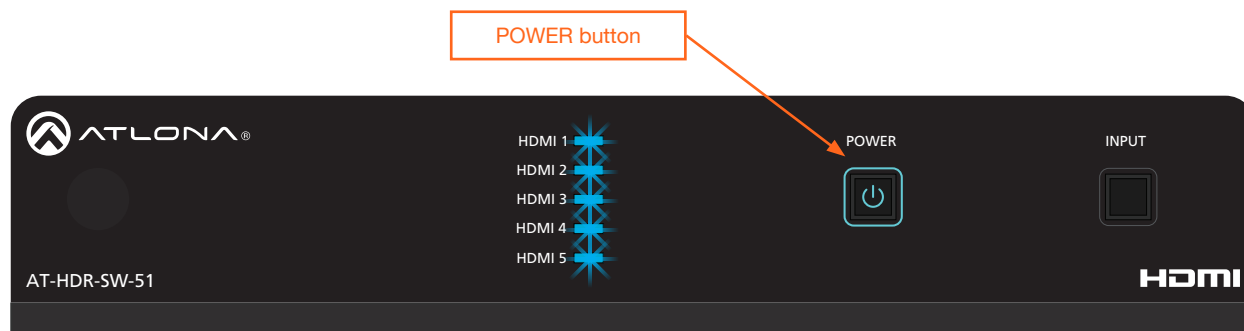

Button flashes	Description	Settings
Two	Static IP mode	IP address: 192.168.1.254 Subnet mask: 255.255.0.0 Gateway: 192.168.1.1
Four	DHCP mode	DHCP server assigned

Using the Web Server

The IP mode of the AT-HDR-SW-51 can also be set using the built-in web server. In order to access the web server, the IP address of the AT-HDR-SW-51 must be known.

1. Open the desired web browser and enter the IP address of the AT-HDR-SW-51.
2. Log in using the required credentials.
3. Click **System** in the menu bar.
4. Click the **IP Mode** toggle to switch between the `DHCP` and `STATIC IP` setting. When set to `STATIC IP`, the **IP**, **Netmask**, and **Gateway** fields can be modified.
5. Click the **Save** button to save the changes.

Network

MAC Address: B8-98-B0-07-AD-26

IP Mode: STATIC IP

IP:

Netmask:

Setting the IP Address Using Commands

Use the `IPStatic` and `IPDHCP` commands to switch between DHCP and IP mode through RS-232 or Telnet. Refer to API documentation for more information.



IMPORTANT: When switching between DHCP and static modes, within a Telnet session, the connection will be terminated once the `IPDHCP` command is executed.

- **Setting static IP mode**

1. Connect to the AT-HDR-SW-51 using RS-232 or Telnet.
2. Execute the `IPStatic` command. This command requires three arguments: the desired IP address of the AT-HDR-SW-51, the subnet mask, and the gateway address. All arguments must be entered in dot-decimal notation. The following is an example:

```
IPStatic 192.168.1.112 255.255.255.0 192.168.1.1
```

└──────────┘
└──────────┘
└──────────┘
IP address
Subnet mask
Gateway

- **Setting DHCP mode**

1. Connect to the AT-HDR-SW-51 using RS-232 or Telnet.
2. At the command line, execute the `IPDHCP on` command using the `on` argument, as shown.

```
IPDHCP on
```

Once DHCP is enabled, the unit will be assigned an IP address by the DHCP server (if present).

Automatic Private IP Addressing (APIPA) Mode

If the AT-HDR-SW-51 is unable to detect a DHCP server within 15 seconds, when set to DHCP mode, then Automatic Private IP Addressing (APIPA) will be used to assign the an address within the IPv4 address block `169.254.xxx.xxx/16`. If a DHCP server is detected while in APIPA mode, then the AT-HDR-SW-51 will be assigned an address from the DHCP server pool. To manually adjust the IP address, connect an Ethernet cable directly from the **LAN** port of the AT-HDR-SW-51 to the LAN port of a computer, then do the following:

1. Click **Start > Settings > Control Panel > Network and Sharing Center**.
2. Click **Change adapter settings**.
3. Right-click on the adapter that is used to establish a wired connection to the network, and select **Properties** from the context menu.
4. Under the **Ethernet Properties** dialog box, select **Internet Protocol Version 4** and then click the **Properties** button. Click the **Use the following IP address** radio button.









IMPORTANT: Before continuing, write down the current IP settings in order to restore them, later. If **Obtain an IP address automatically** and **Obtain DNS server automatically** are selected, then this step is not required.

5. Enter the desired static IP address or the IP address provided by the network administrator. If the computer does not require Internet access or if a statically-assigned IP address is being used, then an address within the IPv4 address block `169.254.xxx.xxx/16` can be entered.
6. Set the subnet mask to `255.255.0.0`.
7. Click the **OK** button then close all **Control Panel** windows.

Device Operation

LED Indicators

The LED indicators on both the front and rear of the unit provide basic information on the current status of the AT-HDR-SW-51.

LED	Description	
HDMI 1 - HDMI 5	Solid blue 	The input is the currently selected (active) input.
	Off 	The input is not the active input.
POWER	Solid blue 	Unit is powered and in normal operating mode. A/V muting is disabled.
	Solid red 	Unit is powered and in standby mode. In this mode, A/V will be muted. <ul style="list-style-type: none"> Press the POWER button to place the unit in normal operating mode.
	Off 	Unit is not powered. <ul style="list-style-type: none"> Check the power supply and make sure it is securely fastened to the captive screw connector on the rear of the unit. Make sure that the power supply is connected to an available electrical outlet and that the outlet is “live” (some outlets are controlled by a wall switch).
	Flashing blue (slow) 	Unit is in Update Mode. Refer to Updating the Firmware (page 50) for more information.

Logging in to the Web Server

Most of the AT-HDR-SW-51 operation is handled through the built-in web server. In order to access the web server, the IP address of the unit must be known. Refer to [IP Configuration \(page 12\)](#) for more information.

Login Registration

Before the built-in web server can be accessed, a username and password must be created.

1. Launch the desired web browser and enter the IP address of the AT-HDR-SW-51 in the address bar.
2. The AT-HDR-SW-51 **Register** page will be displayed.

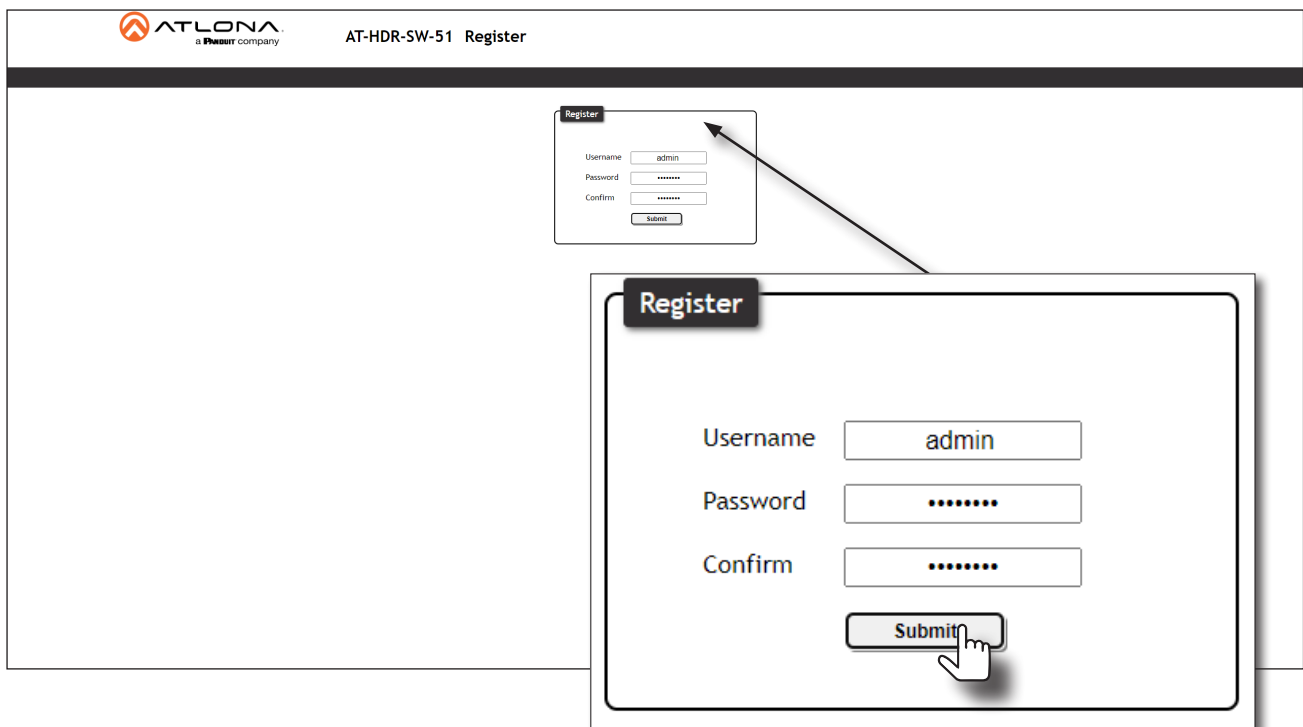

The screenshot shows the AT-HDR-SW-51 Register page. The page header includes the ATLONA logo and the text 'AT-HDR-SW-51 Register'. The main content area contains a registration form with the following fields and values:

Field	Value
Username	admin
Password
Confirm

A 'Submit' button is located below the form fields. A callout box highlights the form fields, and a hand cursor is shown clicking the 'Submit' button.

3. Enter the desired username in the **Username** field. In the example above, the username `admin` is used.
4. Enter the desired password in the **Password** field.



IMPORTANT: The password must contain a minimum of 8 characters, including one uppercase character, one lowercase character, and one number. Special characters are not permitted. Note that the **Password** and **Confirm** fields will be masked when entering the password.

5. Verify the password by entering it in the **Confirm** field.
6. Click the **Submit** button.
7. The **Login** screen will be displayed.

Logging in after Registration

1. Launch the desired web browser and enter the IP address of the AT-HDR-SW-51 in the address bar.
2. Enter the correct username and password in the respective fields.
3. Click the **Submit** button.

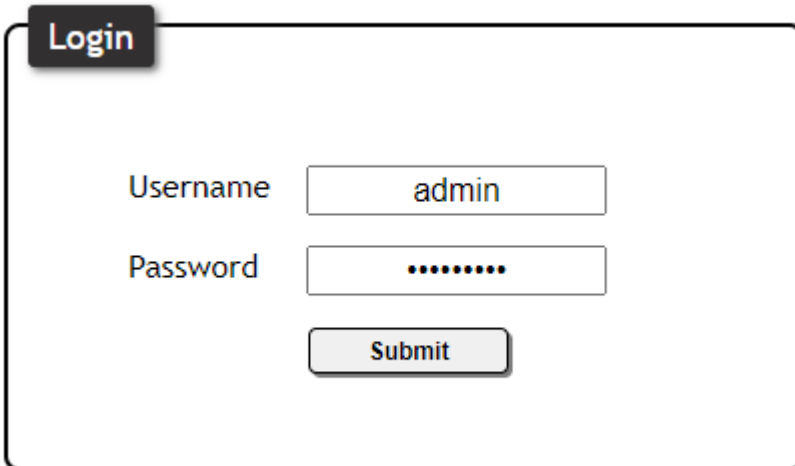

The image shows a login form with a dark grey header containing the word "Login" in white. Below the header, there are two input fields: "Username" with the text "admin" and "Password" with a masked password represented by eight dots. A "Submit" button is located below the password field.

4. The **Info** page will be displayed.

Selecting the Input

Input selection can be performed on the front panel, through the built-in web server, or by executing a command over Telnet. Refer to the API document for the full set of available commands.

Using the Web Server

1. Log in to the web server.
2. Click **A/V Settings** in the menu bar.
3. Click the **Input Selection** drop-down list and select the desired input.

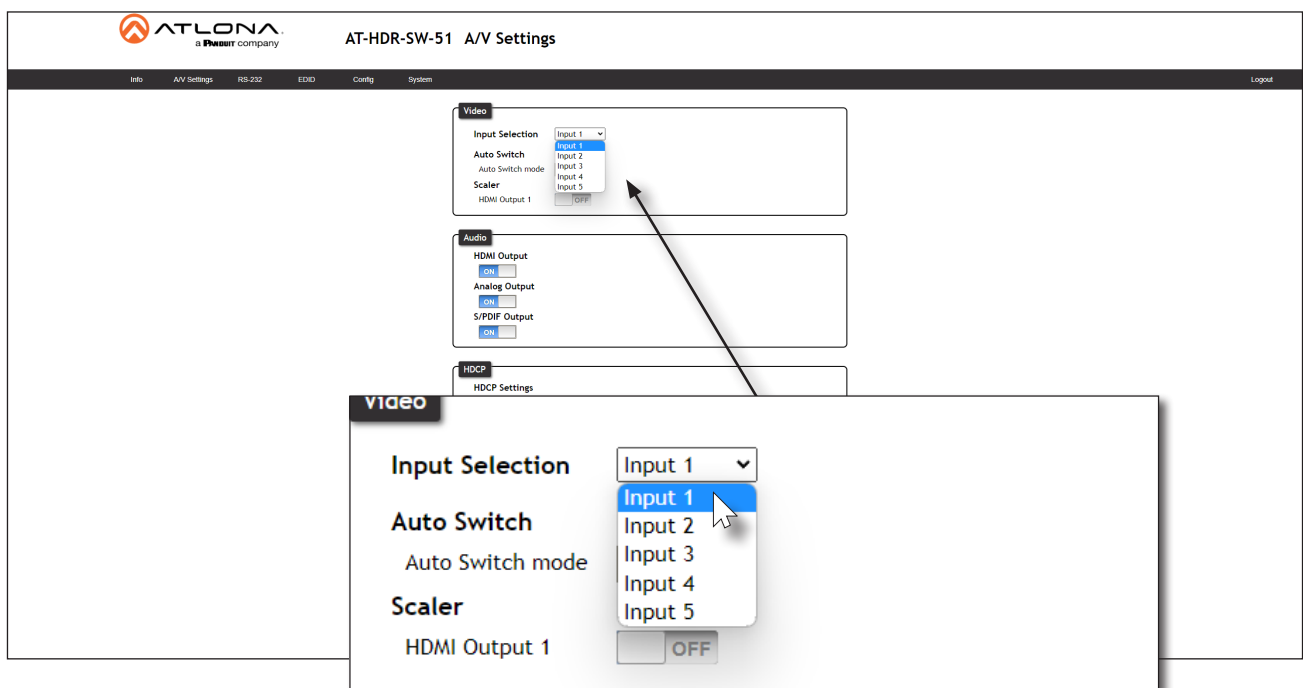

Using the Front Panel

1. Press and release the **INPUT** button on the front panel.
2. Each time the **INPUT** button is pressed, the AT-HDR-SW-51 will advance to the next input. The active input will be displayed by a blue indicator light, as shown below.
3. If the **INPUT** button is pressed when **HDMI 5** is the active input, then HDMI 1 will become the active input.

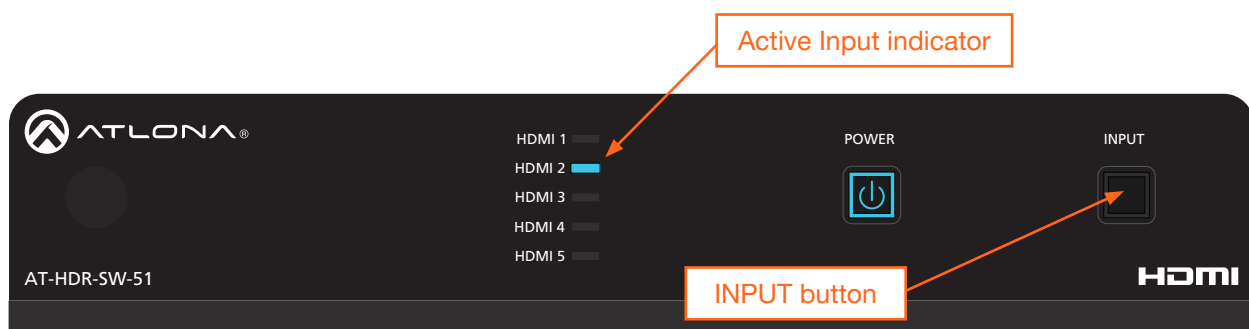

Auto Switching

The AT-HDR-SW-51 provides Auto Switching capability, which is enabled by default. This feature will automatically switch the input to the most recently-connected source. If the active source is disconnected, then the input will automatically be switched to the previously-connected source.

Enabling / Disabling Auto Switching

By default, Auto Switching is enabled on the AT-HDR-SW-51, allowing the unit to automatically switch between inputs when sources are connected or disconnected.

1. Log in to the web server.
2. Click **A/V Settings** in the menu bar.
3. Click the **Auto Switch mode** toggle switch to the **ON** position to enable Auto Switching. This is the default setting. If Auto Switching is not desired, click this toggle switch to the **OFF** position. If the previously active input is no longer available, then the AT-HDR-SW-51 will fallback to any available input.



NOTE: The AT-HDR-SW-51 retains the currently selected input, even after the unit is powered off then powered on. The system should re-evaluate the Auto Switching logic after power on and select an input.

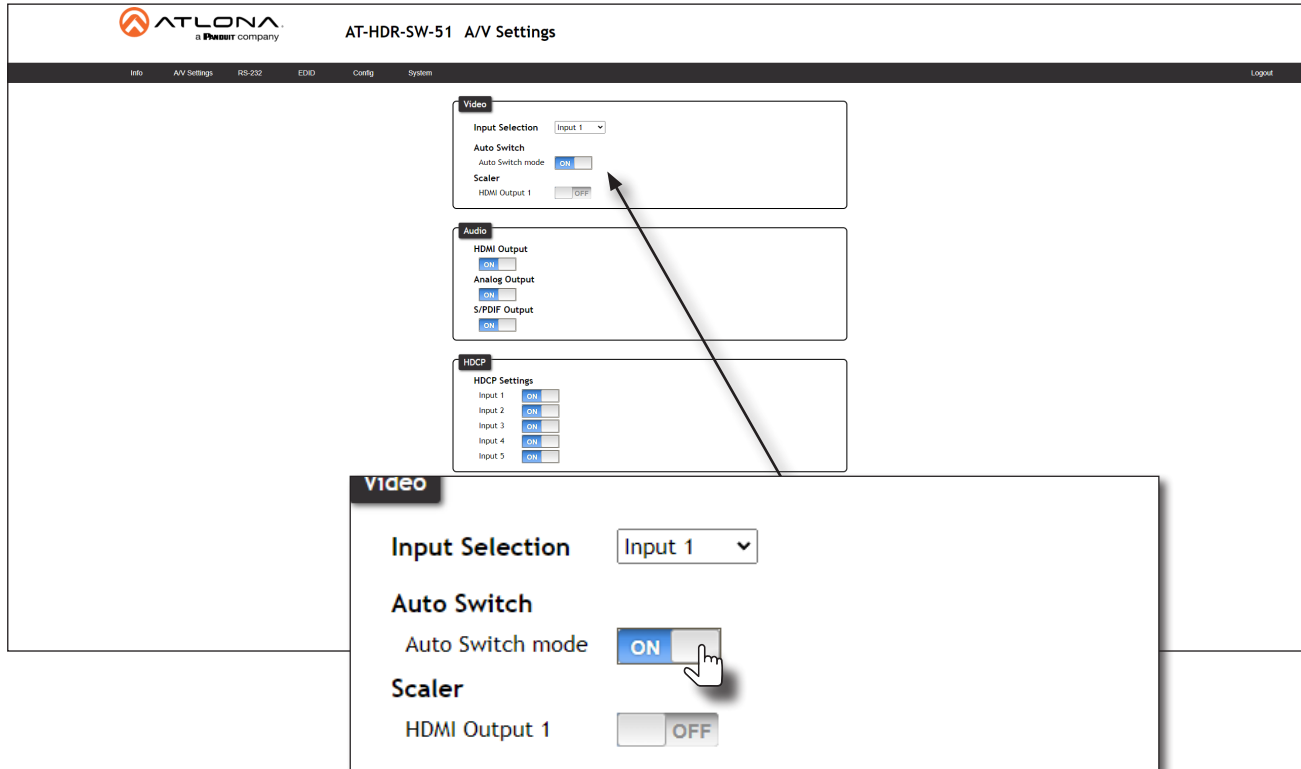

The screenshot displays the AT-HDR-SW-51 A/V Settings web interface. The top navigation bar includes 'Info', 'A/V Settings', 'RS-232', 'EDID', 'Config', 'System', and 'Logout'. The main content area is divided into three sections: Video, Audio, and HDCP Settings. The Video section shows 'Input Selection' set to 'Input 1', 'Auto Switch mode' set to 'ON', and 'Scaler' set to 'OFF'. The Audio section shows 'HDMI Output', 'Analog Output', and 'S/PDIF Output' all set to 'ON'. The HDCP Settings section shows 'Input 1' through 'Input 5' all set to 'ON'. A callout box provides a magnified view of the Video section settings, with a hand cursor clicking the 'Auto Switch mode' toggle switch.

Scaler Pass-Through

Click this toggle switch to enable or disable the scaler pass-through feature. When set to the **ON** position, 4K content will be down-scaled to 1080p when the output device detects a 1080p display on the output. When set to the **OFF** position, the output resolution / timing will be the same as the input source. The default setting is **OFF**. Refer to [Notes on Scaling \(page 21\)](#) for more information.



IMPORTANT: The scaler will only downscale the image resolution and does not support frame rate scaling/conversion such as 60 Hz to 30 Hz. The frame rate of the source must be supported by the display device.

1. Log in to the web server.
2. Click **A/V Settings** in the menu bar.
3. Click the **Scaler > HDMI Output 1** toggle switch to the **ON** position.

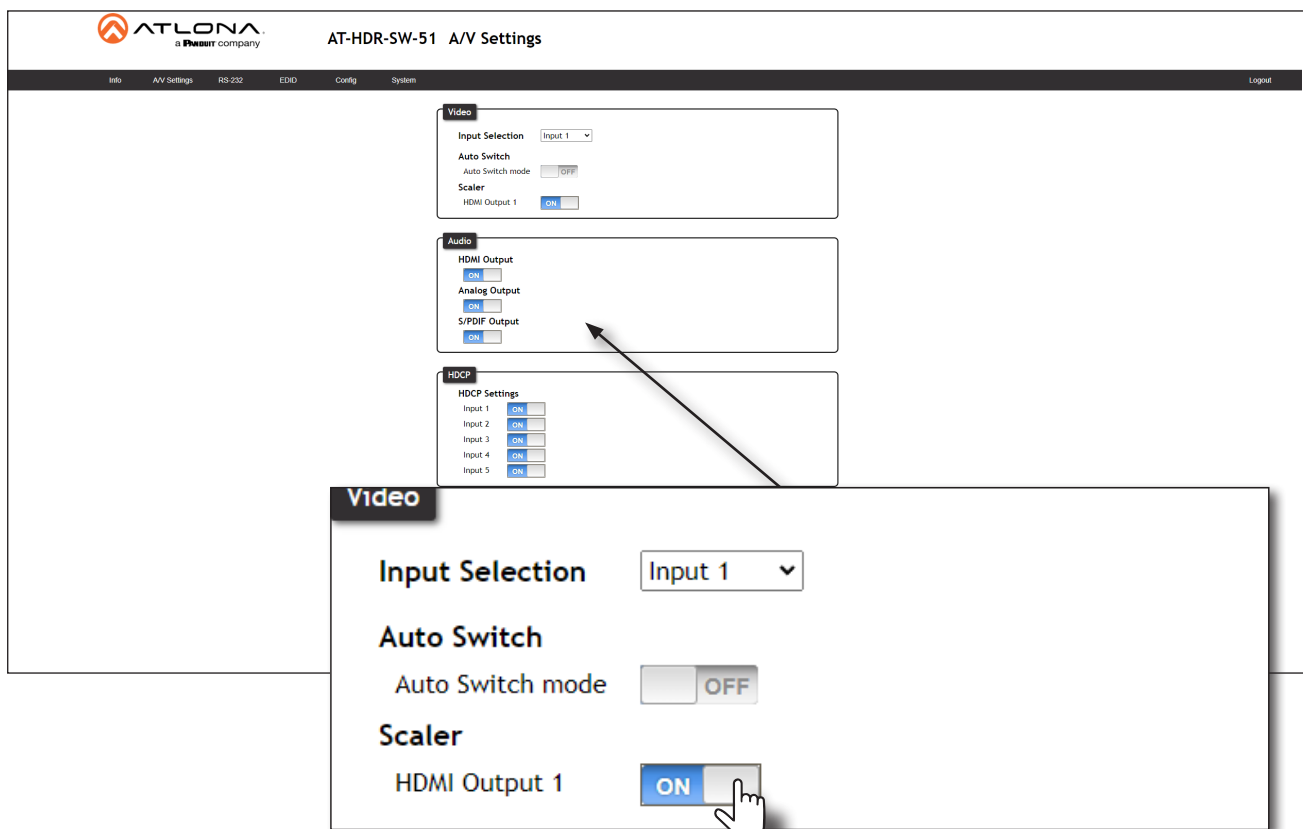

The screenshot shows the AT-LONA web interface for the AT-HDR-SW-51 device, specifically the A/V Settings page. The interface includes a navigation menu with options like 'Info', 'A/V Settings', 'RS232', 'EDID', 'Config', and 'System'. The main content area is divided into sections: 'Video', 'Audio', and 'HDCP'. In the 'Video' section, 'Input Selection' is set to 'Input 1', 'Auto Switch mode' is 'OFF', and 'Scaler' has 'HDMI Output 1' set to 'ON'. A callout box titled 'Video' provides a closer look at these settings, with a mouse cursor clicking the 'ON' toggle for 'HDMI Output 1'.

4. The following message box will be displayed if either toggle switch is enabled. Click **OK** to dismiss the message box.
5. Click the toggle switch again, to return the toggle switch to the **OFF** (default) position.

10.20.20.47 says

Frame rate of the source must be accepted by the scaled display. The scaler will only downscale resolution and not framerate. If you experience black screen this may be due to the frame rate not being supported

OK

Notes on Scaling

The following section provides important information about how the AT-HDR-SW-51 processes 4K (UHD) video signals.

- The **HDMI OUT** port supports up to 4K @ 60 Hz, 12-bit, with HDR.
- If the source is 4K, and the output port is connected to a 1080p (not 4K-capable) display, then the output will be down-scaled as follows:

Input	Output
4K @ 24 Hz	1080p @ 24 Hz
4K @ 30 Hz	1080p @ 30 Hz
4K @ 60 Hz, 4:2:0	1080p @ 60 Hz, YUV/RGB 4:4:4

- HDR / Dolby Vision / HLG formats cannot be downscaled to 1080p.
- The internal scaler will be bypassed if the connected display supports the resolution and timing information from the source device.

Audio Management

The AT-HDR-SW-51 provides independent audio muting. Audio muting can be controlled on the **L/R** and **HDMI OUT** ports. To de-embed the source audio to the **L/R** port, connect an RCA cable to both the **L** and **R** ports. De-embedding audio is restricted to two-channel Linear PCM formats.

HDMI Audio Muting

1. Log in to the web server.
2. Click **A/V Settings** in the menu bar.
3. Locate the **Audio** section.
4. Click the **HDMI Output 1** toggle switch to the **OFF** position. To re-enable the audio for the output, set the toggle switch to the **ON** position.

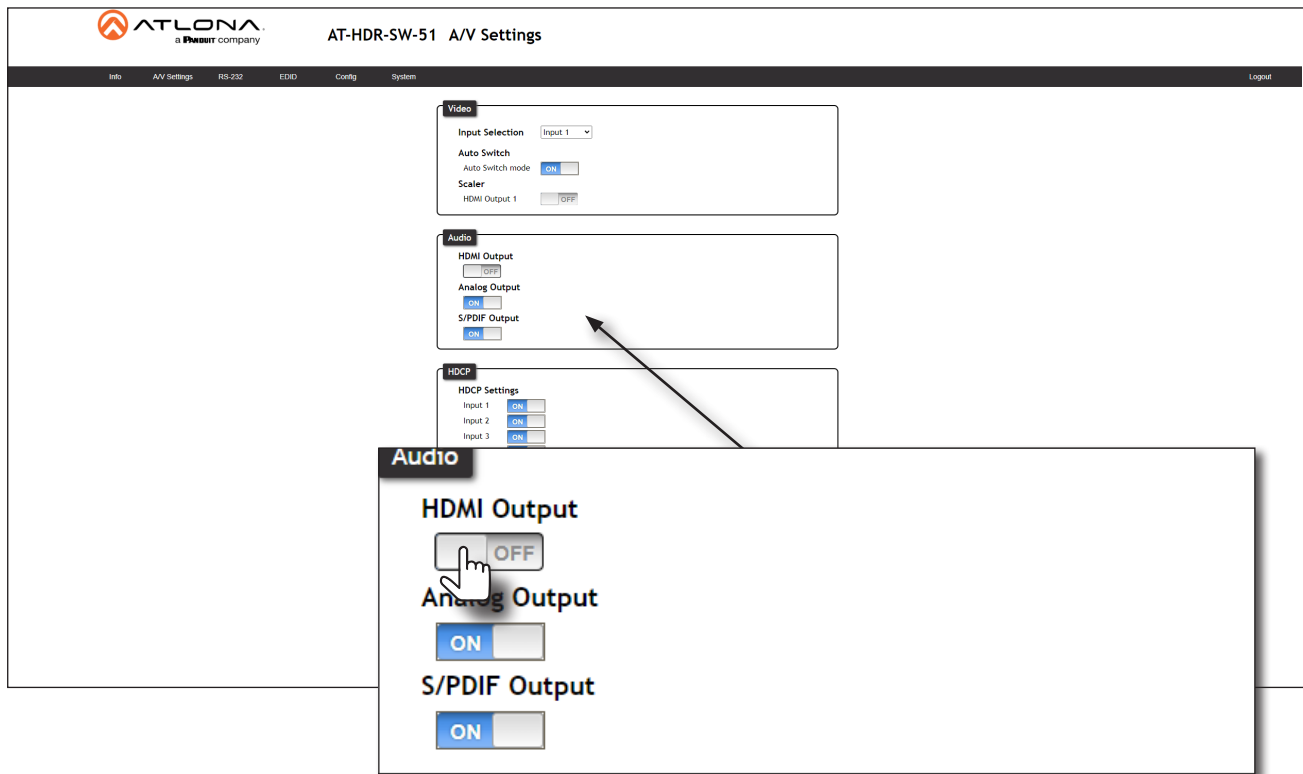

Analog Audio Output

The AT-HDR-SW-51 features a separate **L** and **R** ports on the rear panel. These ports provides de-embedding and conversion of two-channel LPCM audio streams to analog audio.

1. Log in to the web server.
2. Click **A/V Settings** in the menu bar.
3. Locate the **Audio** section.
4. Click the **Analog Output** toggle switch to the **ON** position. To mute the audio on the **L** and **R** ports, click this toggle switch to the **OFF** position.



IMPORTANT: The AT-HDR-SW-51 will only de-embed two-channel LPCM audio. In addition, video must accompany the audio at all times. This product does not support audio-only (“free-run” mode) output.

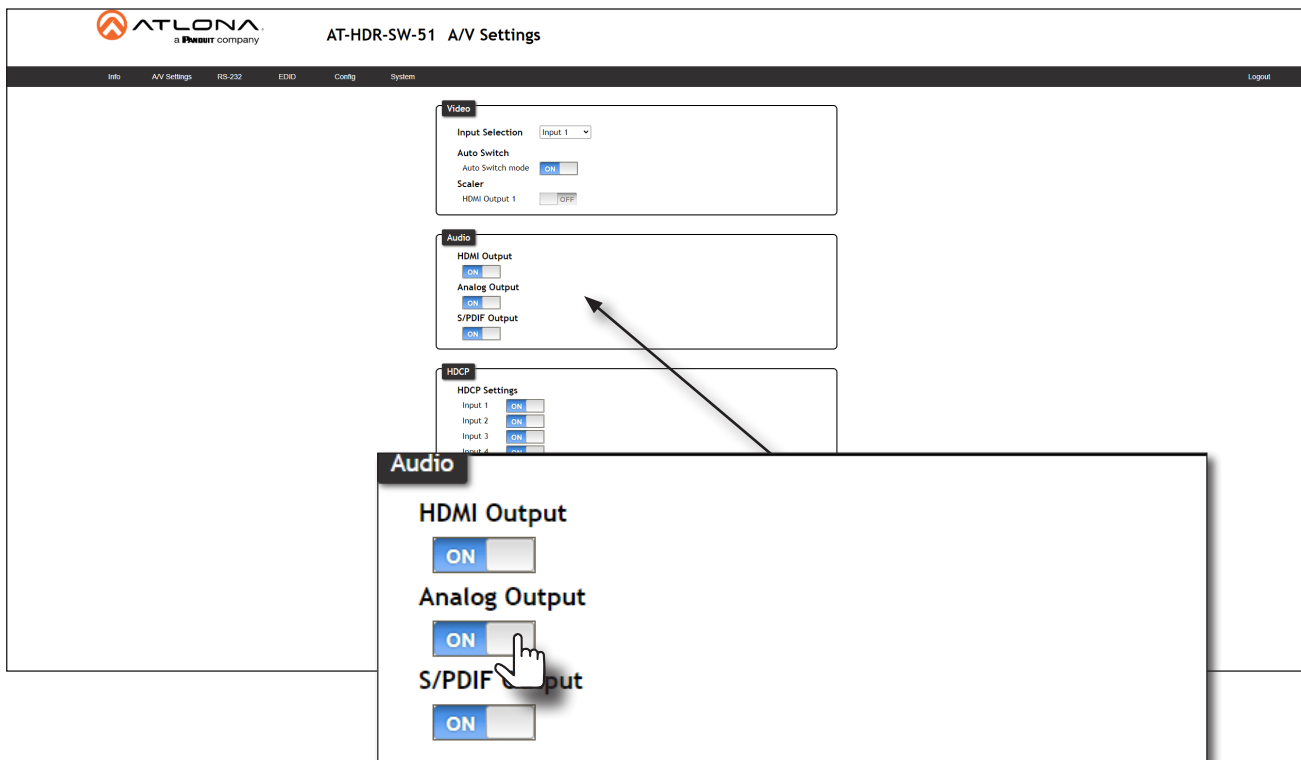

The screenshot displays the AT-HDR-SW-51 web interface, specifically the A/V Settings page. The interface includes a navigation menu at the top with options like Info, A/V Settings, RS-232, EDID, Config, and System. The main content area is divided into sections: Video, Audio, and HDCP. The Audio section is highlighted with a callout box that shows the following settings:

- HDMI Output:** ON
- Analog Output:** ON (with a hand cursor pointing to the toggle)
- S/PDIF Output:** ON

The background interface also shows the Video section with Input Selection (Input 1), Auto Switch (ON), and Scaler (HDMI Output 1 OFF). The HDCP section shows settings for Input 1, 2, 3, and 4, all set to ON.

S/PDIF Audio Muting

1. Log in to the web server.
2. Click **A/V Settings** in the menu bar.
3. Locate the **Audio** section.
4. Click the **S/PDIF Output** toggle switch to the **OFF** position. To re-enable the audio on the **S/PDIF OUT** port, set the toggle switch to the **ON** position.

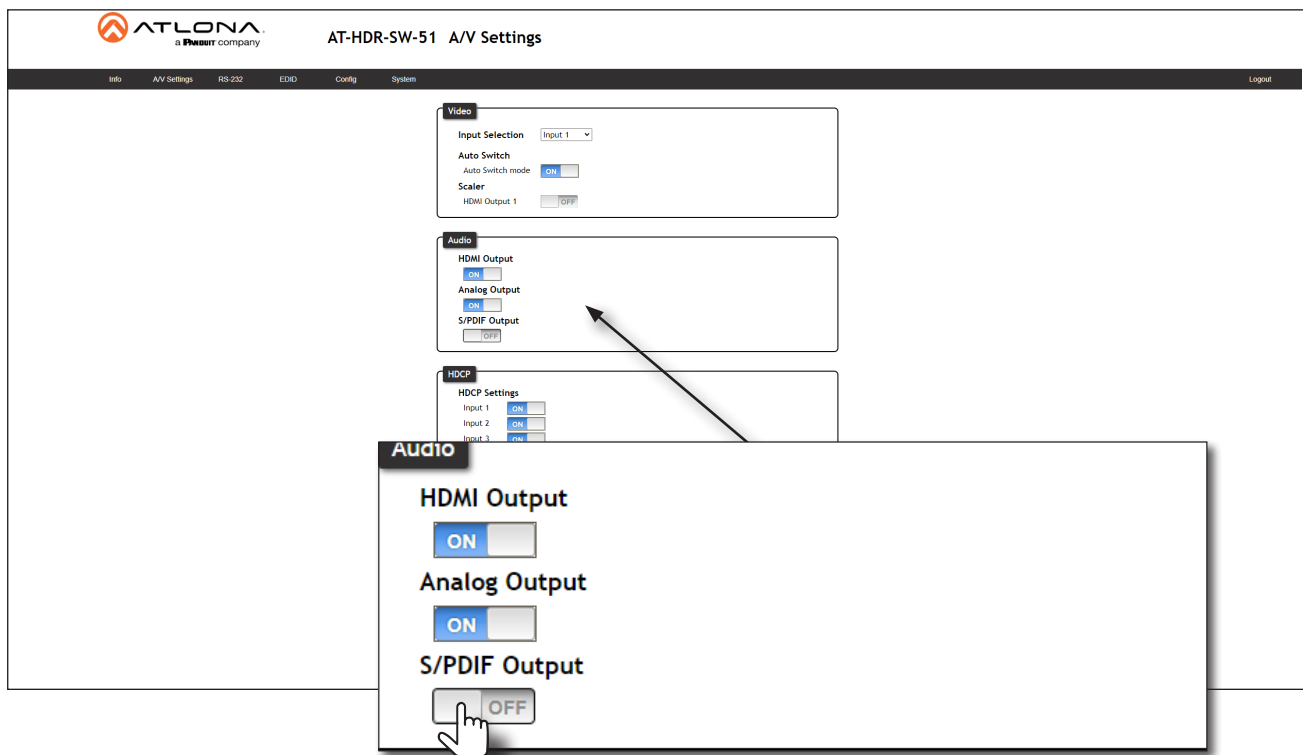

HDCP Content

Transmitting HDCP content to a display that is not HDCP compliant can result in “snow”, image flickering, or no picture. In the illustration below, a laptop source is connected to the AT-HDR-SW-51, which is connected to a display that is not HDCP compliant.



IMPORTANT: Not all source devices are capable of transmitting non-HDCP content. For example, Sony PlayStation® gaming consoles and Mac® computers always transmit HDCP-encrypted content.

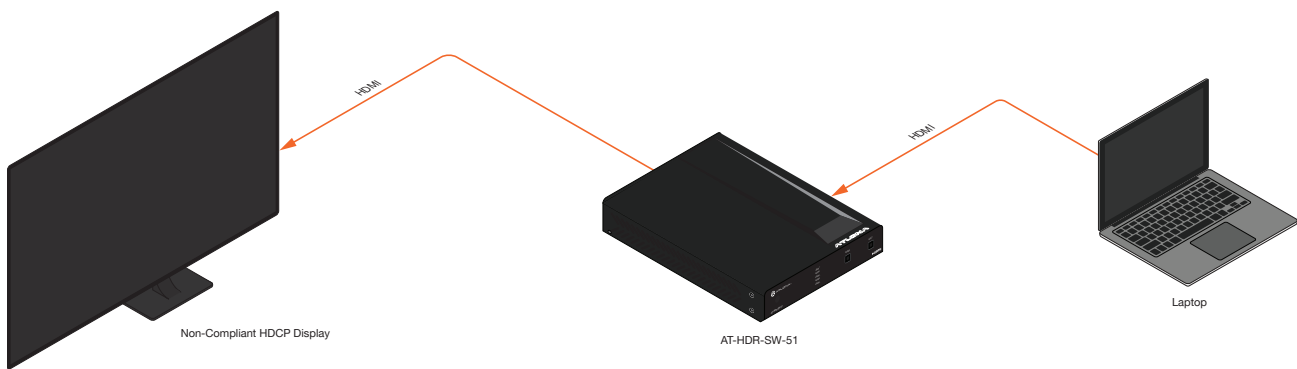

By default, the laptop may transmit HDCP content. However, when connected to a display that does not support HDCP, the laptop must be instructed to send non-HDCP content in order for the content to be displayed.

1. Log in to the web server.
2. Click **A/V Settings** in the menu bar.
3. Locate the **HDCP** section.
4. Click the toggle switch next to the desired input. In this example, clicking the **Input 1** toggle switch and setting it to the **OFF** position will instruct the source device to send non-HDCP content, if possible.



If the display is unable to receive HDCP content, then a “black screen” with no image will be displayed.

RS-232 Control

The **RS-232** port is used to directly control the AT-HDR-SW-51 using a control system.

1. Log in to the web server.
2. Connect the RS-232 cable between the control system and the **RS-232** port on the AT-HDR-SW-51. The included 3-pin captive screw should be wired as shown.

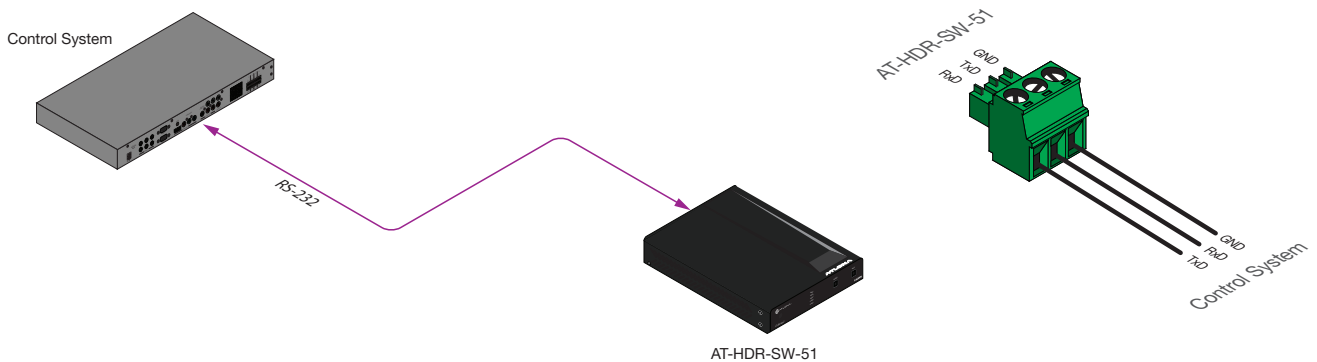

3. Click **RS-232** in the menu bar.
4. Select the proper baud rate, data bit, parity, and stop bit settings. These settings must correspond with the control system RS-232 settings.

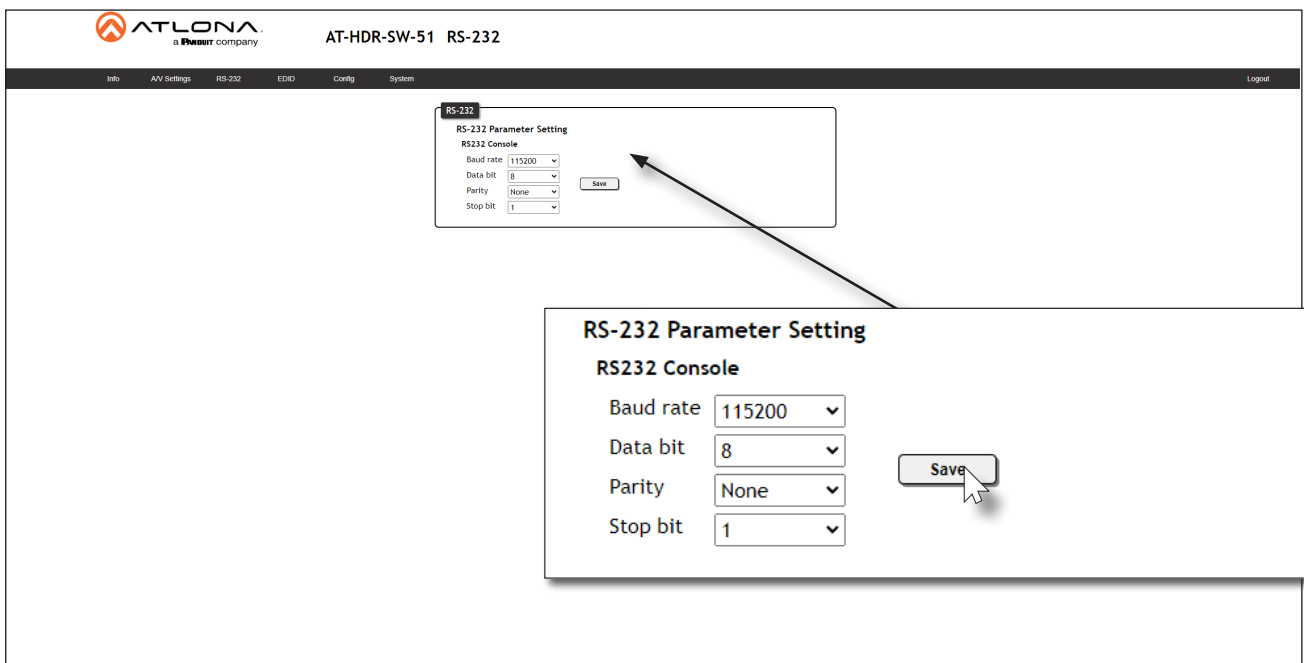

5. Click the **Save** button to commit changes.

EDID Management

Before a source can send picture and sound to a display device, the source reads the EDID (Extended Display Identification Data) stored in the display. The EDID contains information about what type of video and audio formats are supported by the display. The AT-HDR-SW-51 can use either the downstream EDID (from the display/sink) or use a built-in EDID preset. EDID data can also be stored in any of eight EDID presets. This section will cover each of the following topics:

- Using the Downstream EDID
- EDID Presets
- Storing EDID Data

Using the Downstream EDID

By default, the AT-HDR-SW-51 will read the EDID from the display device. The term “downstream” is used to describe any device that receives a signal from another device. For example, if a Blu-ray player is connected to a display, the display is said to be “downstream” of the Blu-ray player.

1. Log in to the web server.
2. Click **EDID** in the menu bar.
3. Locate the **EDID Settings** section.
4. Click the drop-down list, next to the input that is connected to the source device, and select **Connected Display**. For example, if **HDMI IN 1** is connected to a source, click the **Input 1** drop-down list and select **Connected Display**. The source device will read the EDID of the connected display and determine all supported video and audio formats.

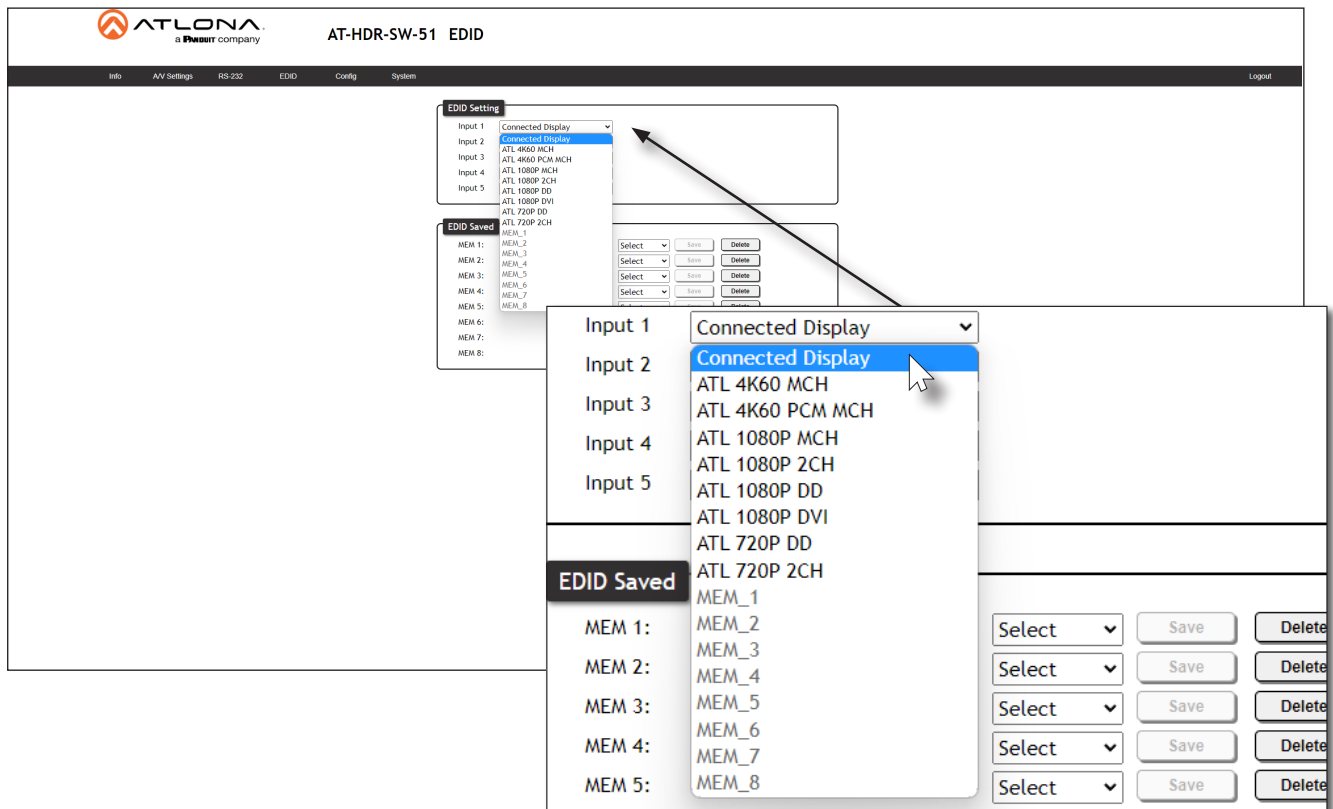

EDID Presets

The AT-HDR-SW-51 provides the option of selecting a preset EDID. The following presets are available.

EDID	Description
Connected Display (Default)	Uses the downstream EDID of the connected display
ATL 4K60 MCH	3840 x 2160 (UHD) with multichannel audio support
ATL 4K60 PCM MCH	3840 x 2160 (UHD) with PCM multichannel audio support
ATL 1080P MCH	1920 x 1080p with multichannel audio support
ATL 1080P 2CH	1920 x 1080p with two-channel audio support
ATL 1080P DD	1920 x 1080p with Dolby™ Digital audio support
ATL 1080P DVI	1920 x 1080p for DVI displays
ATL 720P DD	1280 x 720p with Dolby™ Digital audio support
ATL 720P 2CH	1280 x 720p with two-channel audio support

1. Log in to the web server.
2. Click **EDID** in the menu bar.
3. Locate the **EDID Settings** section.
4. Click the drop-down list, next to the port that is connected to the source device, and select the desired EDID preset. For example, if **HDMI IN 1** is connected to the source, click the **Input 1** drop-down list and select the desired EDID. The source device will use the selected EDID to determine all supported video and audio formats.



IMPORTANT: If problems are encountered when using an EDID preset, it is recommended that the input be set to *Connected Display*. Not all displays will support all video and audio formats in a given EDID preset.

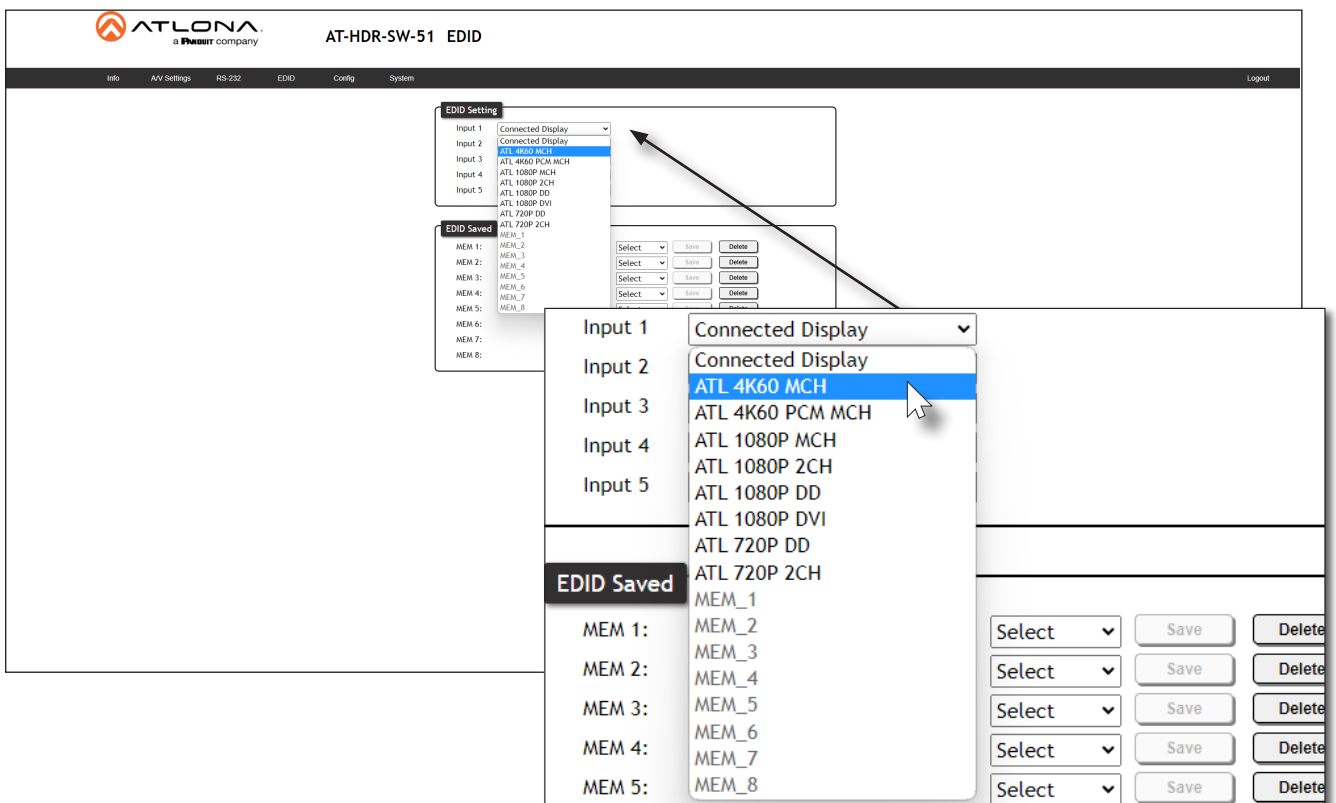

Storing EDID Data

The AT-HDR-SW-51 provides eight memory locations which can be used to store EDID data. Any downstream EDID can be captured and stored in these locations. Each memory location is non-volatile and captured EDID data is stored after power is disconnected from the unit.

1. Connect an HDMI cable from the **HDMI OUT** port on the AT-HDR-SW-51 to the HDMI input on the display, containing the EDID to be stored.
2. Log in to the web server.

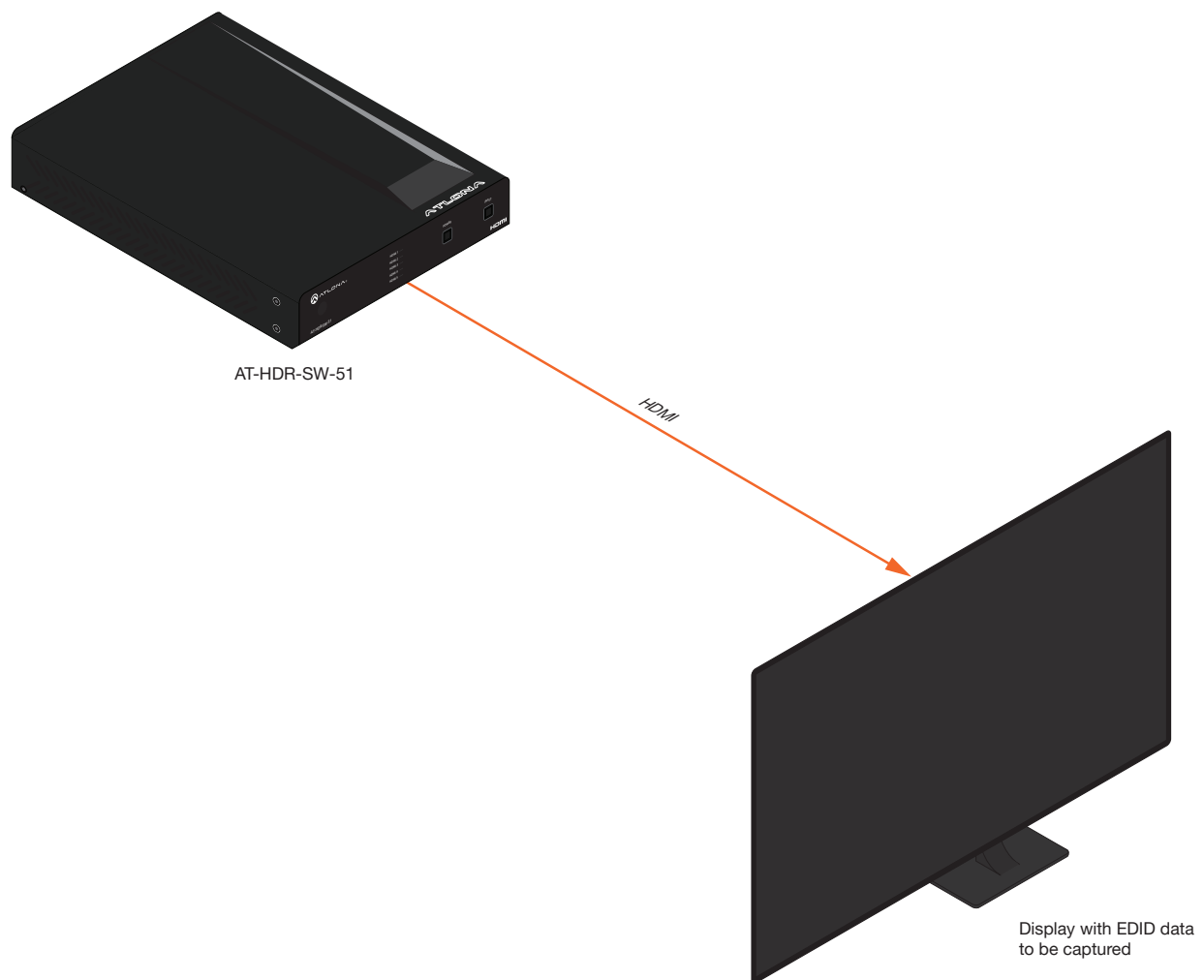

3. Click **EDID** in the menu bar.
4. Locate the **EDID Saved** section.
5. Click the drop-down list, next to the memory location to be used, and select `Output 1` from the drop-down list. Refer to the next page for more information.

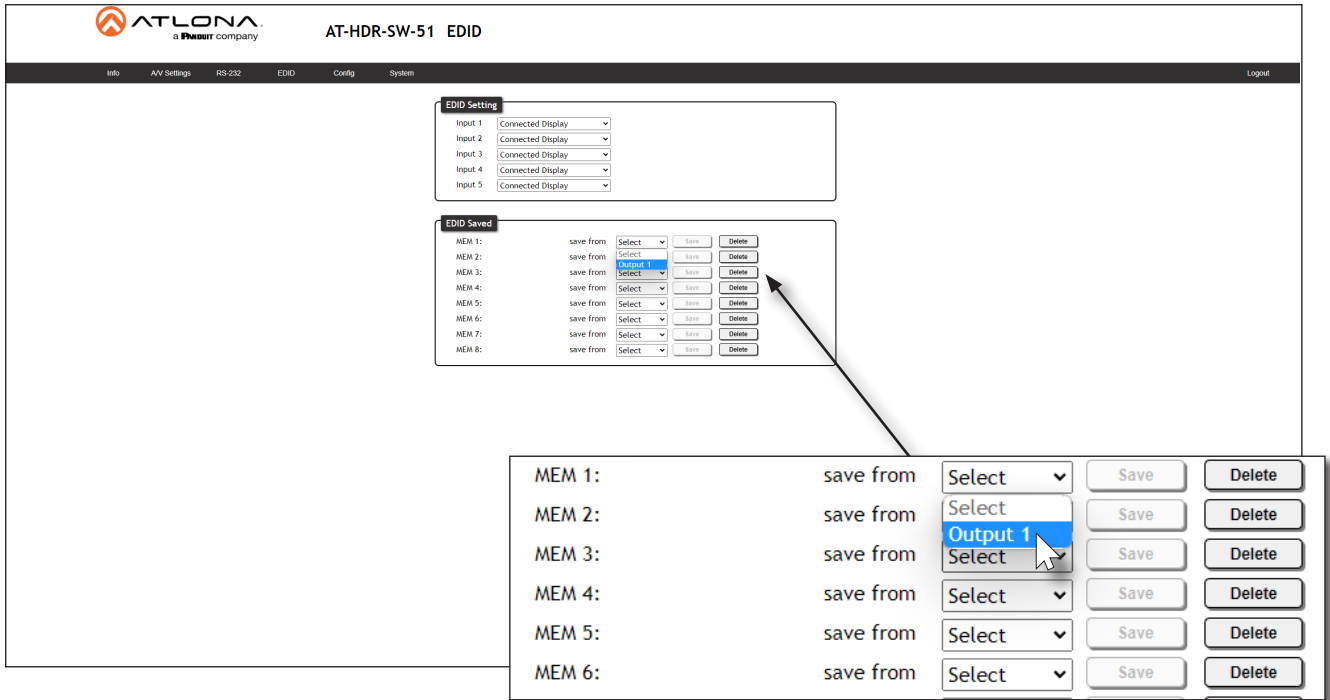

6. Click the **Save** button next to the drop-down list for the memory location.

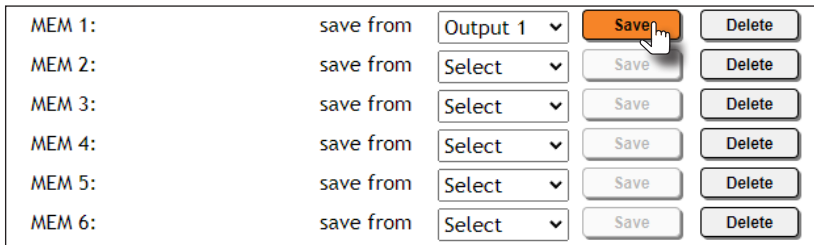

7. The saved EDID will appear next to the memory location, as shown below.

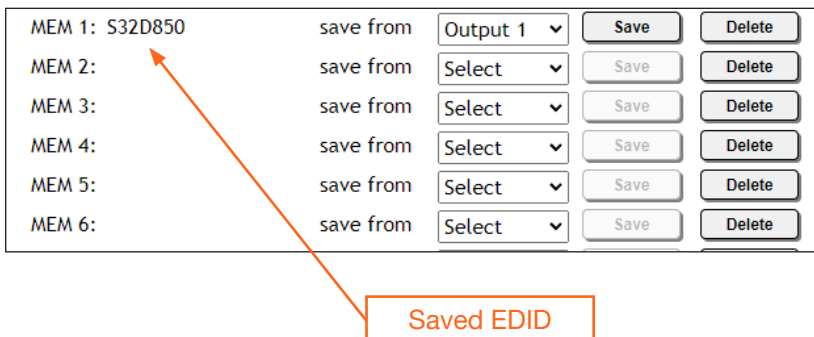

8. Click any of the input drop-down list boxes. Note that the stored EDID appears as an available EDID preset for each available input on the AT-HDR-SW-51.

Input 1	Connected Display	
Input 2	Connected Display	
Input 3	ATL 4K60 MCH	
Input 4	ATL 4K60 PCM MCH	
Input 5	ATL 1080P MCH	
	ATL 1080P 2CH	Saved EDID
	ATL 1080P DD	
	ATL 1080P DVI	
	ATL 720P DD	
	ATL 720P 2CH	
EDID Saved	S32D850	
MEM 1:	MEM_2	Output 1
MEM 2:	MEM_3	Select
MEM 3:	MEM_4	Select
MEM 4:	MEM_5	Select
MEM 5:	MEM_6	Select
MEM 6:	MEM_7	Select
	MEM_8	Select
	save from	Select
		Save
		Delete
		Save
		Delete
		Save
		Delete
		Save
		Delete
		Save
		Delete



NOTE: Once an EDID is written to a memory location, it can be overwritten with a different EDID, when desired. To overwrite an EDID with a different EDID, repeat steps 5 through 7, above.

User Management

The AT-HDR-SW-51 allows the login credentials to be changed. The username and password applies to both the web server and Telnet sessions.

1. Log in to the web server.
2. Click **Config** in the menu bar.
3. Click the **Old Username** field and enter the current username.
4. Click the **Old Password** field and enter the current password.

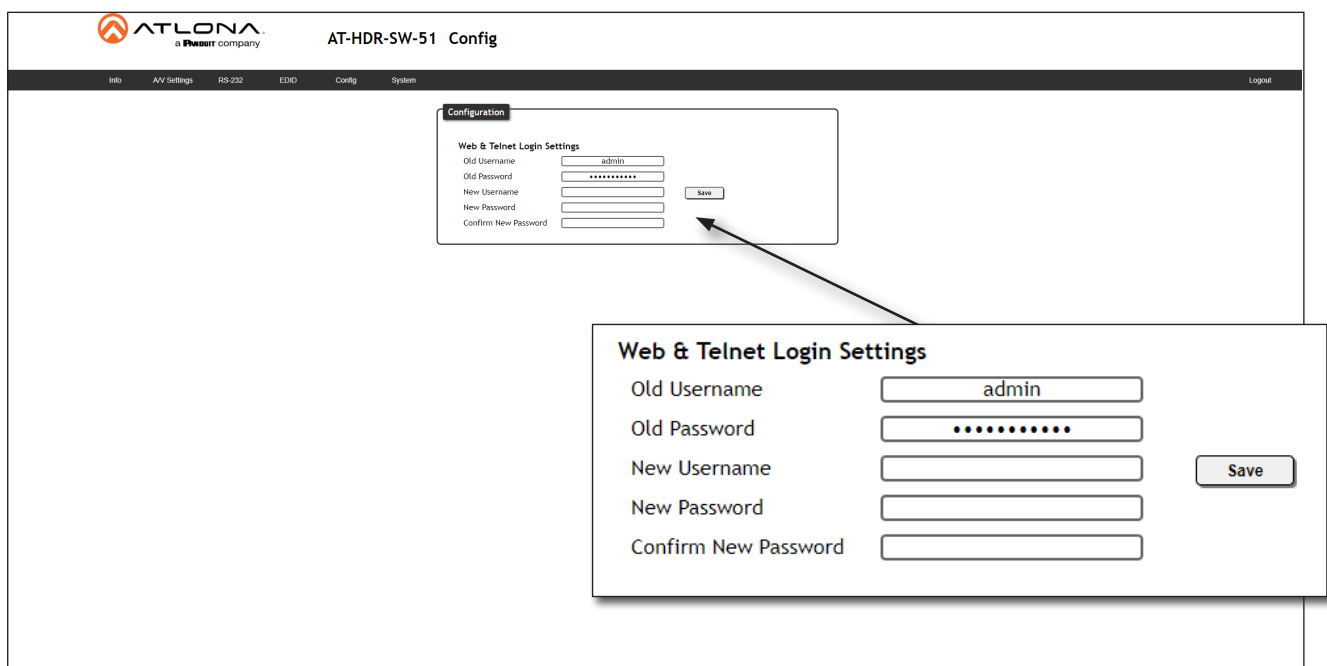

The screenshot shows the AT-HDR-SW-51 Config page. The 'Web & Telnet Login Settings' form is highlighted. The fields are: Old Username (admin), Old Password (masked), New Username (empty), New Password (empty), and Confirm New Password (empty). A 'Save' button is present. An arrow points from a larger, detailed view of the form to the main screenshot.

5. Enter the new username in the **New Username** field.
6. Enter the new password in the **New Password** field.
7. Retype the new password in the **Confirm New Password** field.

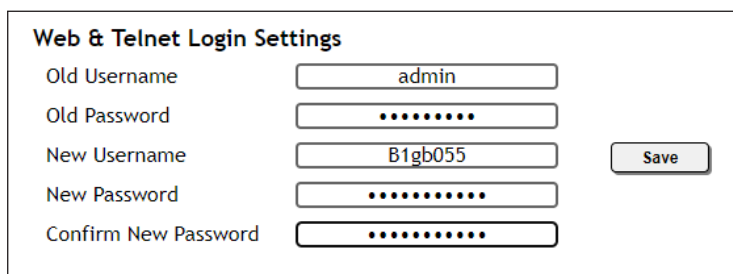

The detailed view of the 'Web & Telnet Login Settings' form shows the following values: Old Username: admin, Old Password: masked, New Username: B1gb055, New Password: masked, and Confirm New Password: masked. A 'Save' button is visible.



NOTE: Password fields will always be masked for security purposes.

8. Click the **Save** button to commit changes. To login with the new username and password, click **Logout** in the upper-right corner of the screen, then enter the new login credentials on the **Login** page.

System Configuration

The AT-HDR-SW-51 provides easy access to system configuration through the built-in web server, and is the recommended method to adjust network settings.

Getting the MAC Address

1. Log in to the web server.
2. Click **System** in the menu bar.
3. Locate the MAC address field, as shown below. This is the hardware address of the AT-HDR-SW-51.

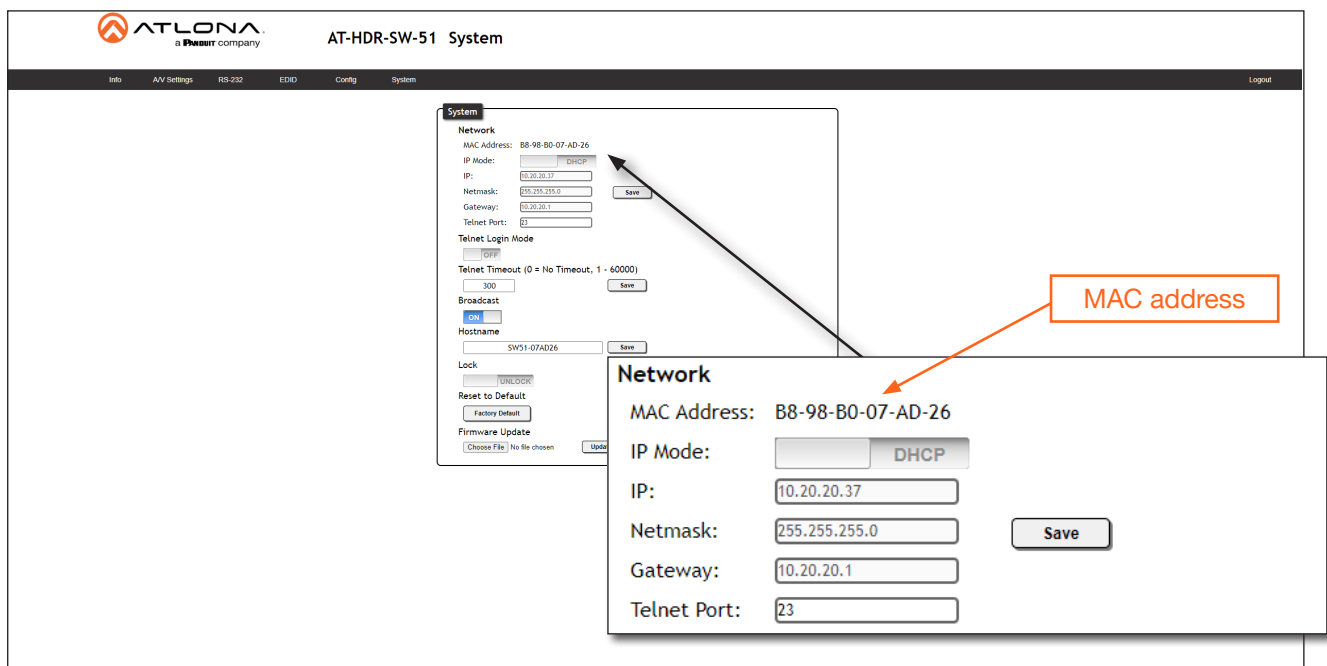

Changing the Network IP Mode

By default, the AT-HDR-SW-51 is set to DHCP mode. Once connected to a network, and if a DHCP server is found (or available), the AT-HDR-SW-51 will be assigned an IP address on the network, and no further network configuration is required. However, if the AT-HDR-SW-51 is unable to detect a DHCP server within 15 seconds, then the unit will use a self-assigned IP address within the range of 169.254.xxx.xxx/16. The instructions below will focus on setting the AT-HDR-SW-51 to static IP mode.



IMPORTANT: Before assigning a static IP address to the AT-HDR-SW-51, it is recommended to consult with the network or system administrator and obtain a available IP address. Assigning the AT-HDR-SW-51 to an IP address which is already in use can result in network issues or difficulty in accessing the AT-HDR-SW-51.

1. Log in to the web server.
2. Click **System** in the menu bar.

3. Locate the **IP Mode** toggle switch. The default setting of this toggle switch is `DHCP`.
4. Click this toggle switch to set it to `STATIC IP`.
5. Enter the desired IP address for the AT-HDR-SW-51 in the **IP** field.
6. Enter the subnet mask and gateway (router) address in the **Netmask** and **Gateway** fields, respectively.
7. Click the **Save** button to commit changes. Changes will take effect immediately.

Network

MAC Address: B8-98-B0-07-AD-26

IP Mode: **STATIC IP** DHCP

IP:

Netmask:

Gateway:

Telnet Port:

Changing the Telnet Port

Typically, the Telnet service is assigned to TCP port 23. This is the default setting for the AT-HDR-SW-51. However, depending upon the network environment, the default Telnet port can be changed. The Telnet port can be changed independently of the IP mode.

1. Log in to the web server.
2. Click **System** in the menu bar.
3. Locate the **Telnet Port** field and enter the desired port in the field.
4. Click **Save** to commit changes.

Network

MAC Address: B8-98-B0-07-AD-26

IP Mode: STATIC IP **DHCP**

IP:

Netmask:

Gateway:

Telnet Port:

Telnet Login Mode

When a Telnet session is requested, the AT-HDR-SW-51 provides the option to prompt for user credentials or bypass authentication before the Telnet session begins. This credentials prompt option can be enabled or disabled. When prompting for user credentials, use the same login information required by the built-in web server.

1. Log in to the web server.
2. Click **System** in the menu bar.
3. Click the **Telnet Login Mode** toggle switch. Set this toggle switch to **ON** to prompt for user credentials. Set this toggle switch to **OFF** to bypass the request for user credentials request.
4. Click **Save** to commit changes.

Network

MAC Address: B8-98-B0-07-AD-26

IP Mode: **DHCP**

IP:

Netmask:

Gateway:

Telnet Port:

Telnet Login Mode

OFF

Telnet Timeout

If there is no activity within a specified amount of time, during a Telnet session, the session can automatically be closed. By default, the AT-HDR-SW-51 will close a Telnet session after 300 seconds of inactivity. If this field is set to 0, then the timeout interval is infinite.

1. Log in to the web server.
2. Click **System** in the menu bar.
3. Enter the desired timeout value, in seconds. The following integer values can be specified: 0 - 60000.
4. Click **Save** to commit changes.

Network

MAC Address: B8-98-B0-07-AD-26

IP Mode: **DHCP**

IP:

Netmask:

Gateway:

Telnet Port:

Telnet Login Mode

OFF

Telnet Timeout (0 = No Timeout, 1 - 60000)

Broadcast

This feature determines whether or not systems changes are announced over TCP/IP connections to any listening devices.

1. Log in to the web server.
2. Click **System** in the menu bar.
3. Click the **Broadcast** toggle switch to the desired setting.

Setting	Description
ON	System changes will be announced over TCP/IP connections to any device that has a TCP/IP connection to the AT-HDR-SW-51. This is the default setting.
OFF	Only the device that is sending the commands will receive feedback from the commands or any system changes. Read queries, such as the <code>IPCFG</code> and <code>Type</code> commands, are not announced and will only return information to the requester.

4. Click **Save** to commit changes.

Setting the Host Name

By default, the AT-HDR-SW-51 is assigned a hostname, which is constructed as follows:

SW52-[last six digits of MAC address]

For example, a default hostname might look like this: SW52-074431. This value can be changed to easily identify the AT-HDR-SW-51 within Velocity Device Manager or on a network. The hostname cannot exceed 15 characters in length.

1. Log in to the web server.
2. Click **System** in the menu bar.
3. Click the **Hostname** field and enter the desired name.
4. Click **Save** to commit changes.

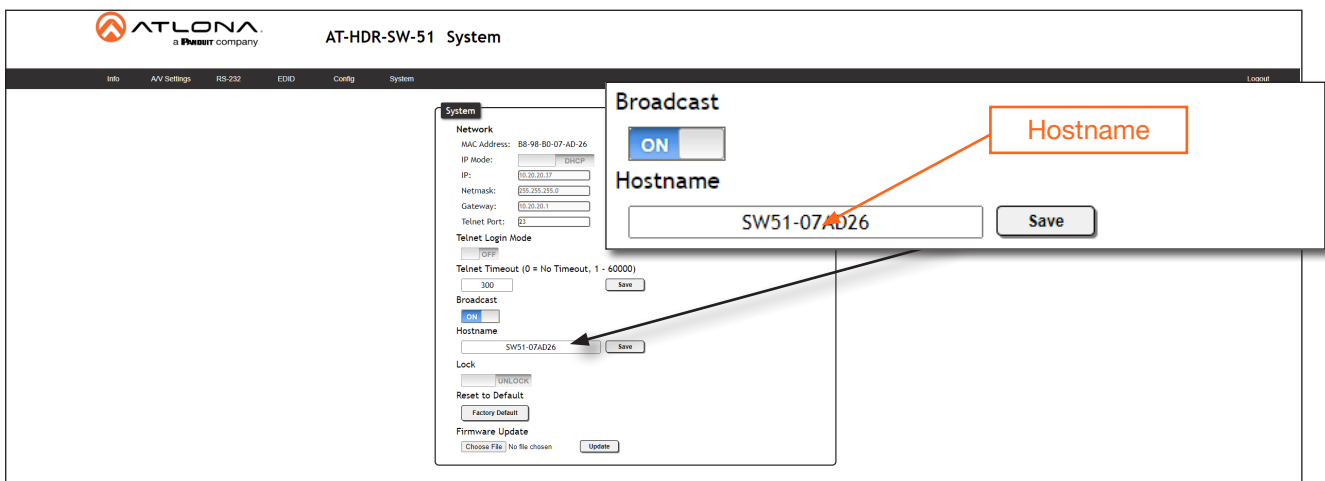

The screenshot shows the AT-HDR-SW-51 System configuration page. The 'Broadcast' toggle is set to 'ON'. The 'Hostname' field is highlighted with an orange box and contains the text 'SW51-07AD26'. A 'Save' button is visible next to the hostname field. The 'System' menu is open, showing various configuration options like Network, Telnet, Broadcast, and Lock.

Locking / Unlocking the Front Panel

To prevent accidental pressing of the front panel buttons, the front panel buttons can be locked. This may be desirable if, for example, the AT-HDR-SW-51 is installed in a rack environment. By default, the front panel buttons are unlocked.

1. Log in to the web server.
2. Click **System** in the menu bar.
3. Click the **Lock** toggle switch to toggle between values. When set to **LOCK**, all buttons on the front panel will remain disabled until the toggle switch is set to **UNLOCK**.

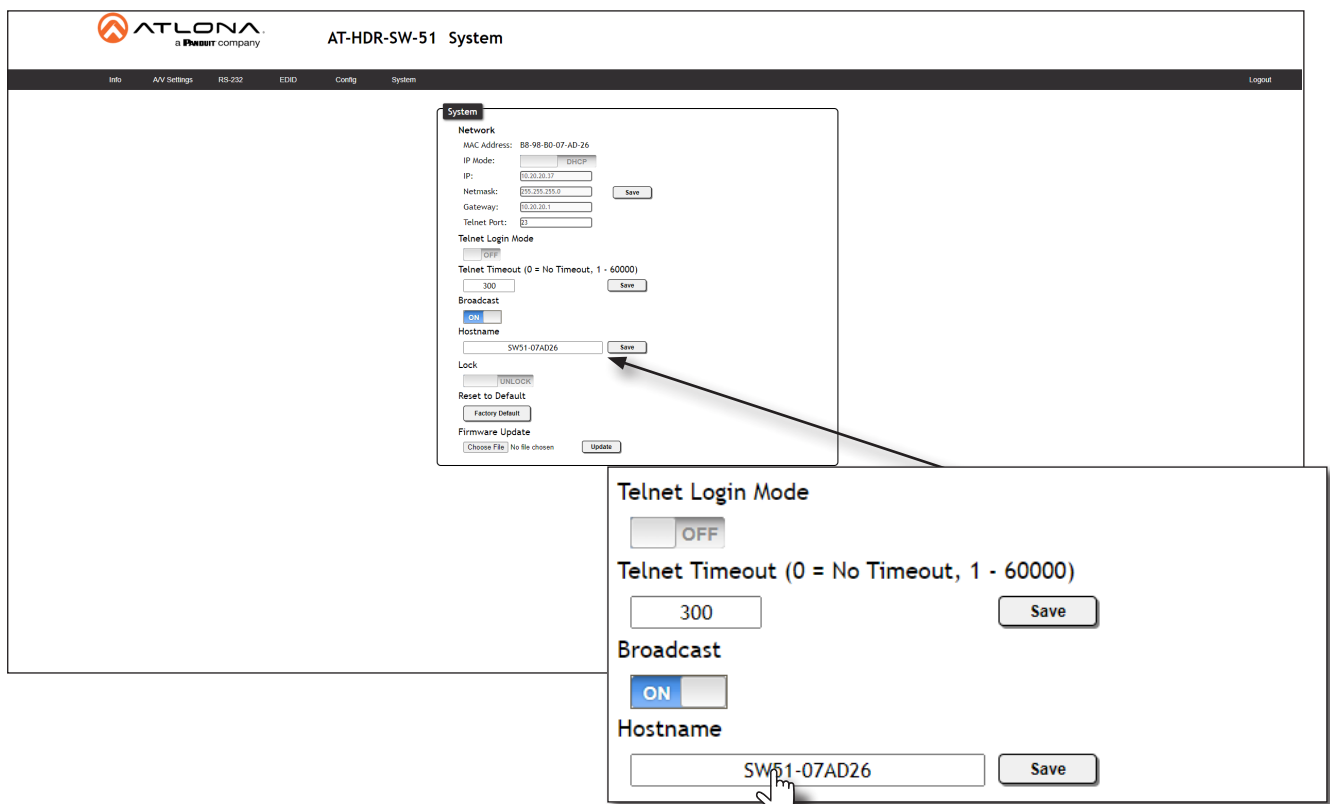

The screenshot displays the AT-HDR-SW-51 System web interface. The main configuration area is titled "System" and includes sections for Network, Telnet Login Mode, Broadcast, Hostname, Lock, Reset to Default, and Firmware Update. A callout box highlights the "Lock" section, which shows a toggle switch currently set to "UNLOCK". The callout also shows the "Telnet Login Mode" set to "OFF", "Telnet Timeout" set to "300", "Broadcast" set to "ON", and "Hostname" set to "SW51-07AD26".

Resetting to Factory Defaults

Using the Web Server

The following procedure will reset the AT-HDR-SW-51 to factory-default settings. The network IP mode will be set to DHCP mode.

1. Log in to the web server.
2. Click **System** in the menu bar.
3. Click the **Factory Default** button.

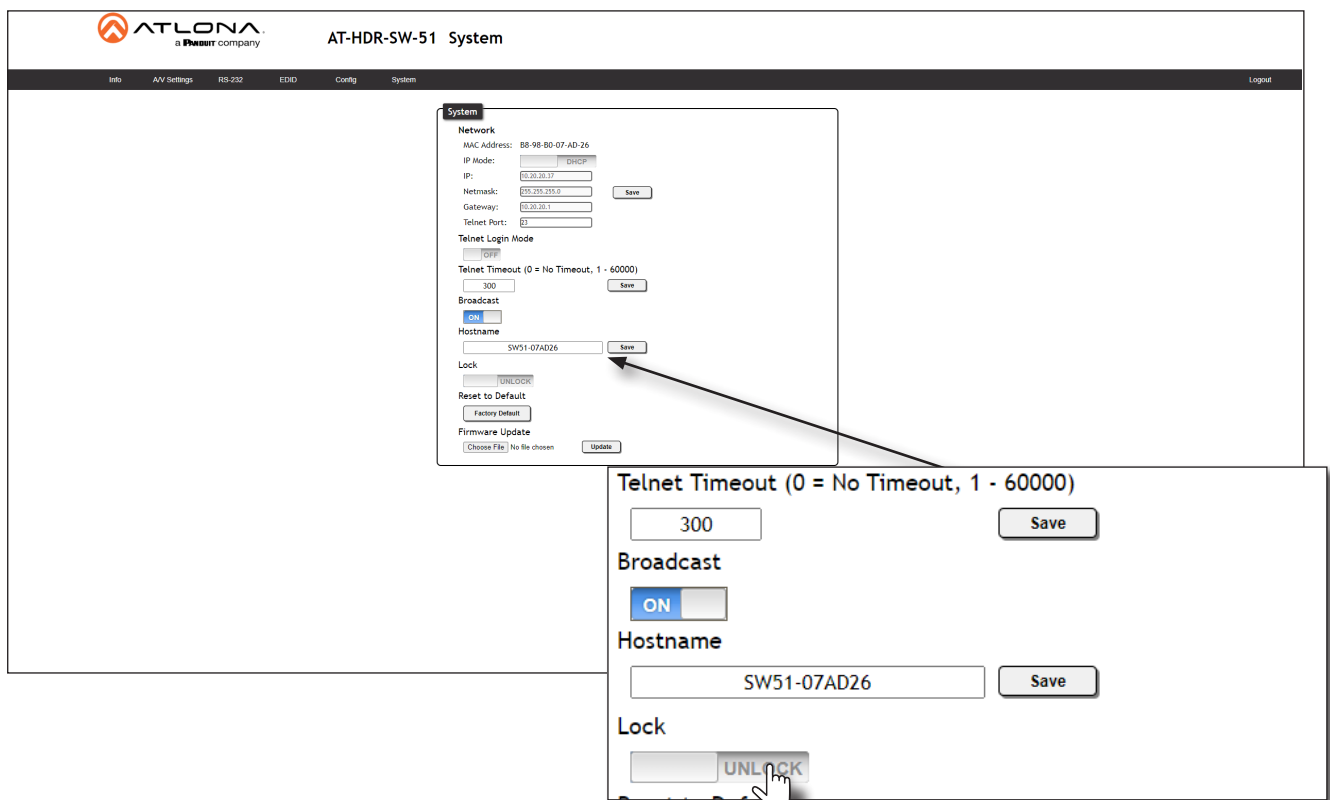

The screenshot shows the AT-HDR-SW-51 System configuration page. The 'System' menu is open, and the 'Factory Default' button is highlighted with a red arrow. A zoomed-in view of the 'Factory Default' button is shown below, with a mouse cursor clicking on it.

4. The following message will be displayed at the top of the screen. Click **OK** to continue with the factory-default reset procedure. Click **Cancel** to abort the process.

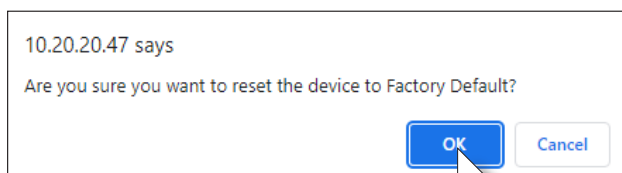

10.20.20.47 says
Are you sure you want to reset the device to Factory Default?

OK Cancel

5. Once the factory-default process is complete, the web server **Login** screen will be displayed.

Using the Front Panel

1. Press and hold both the **POWER** and **INPUT** buttons for 15 seconds.
2. Release both **POWER** and **INPUT** buttons once the front panel LED indicators turn on. After two seconds, the front panel LED indicators will turn off.

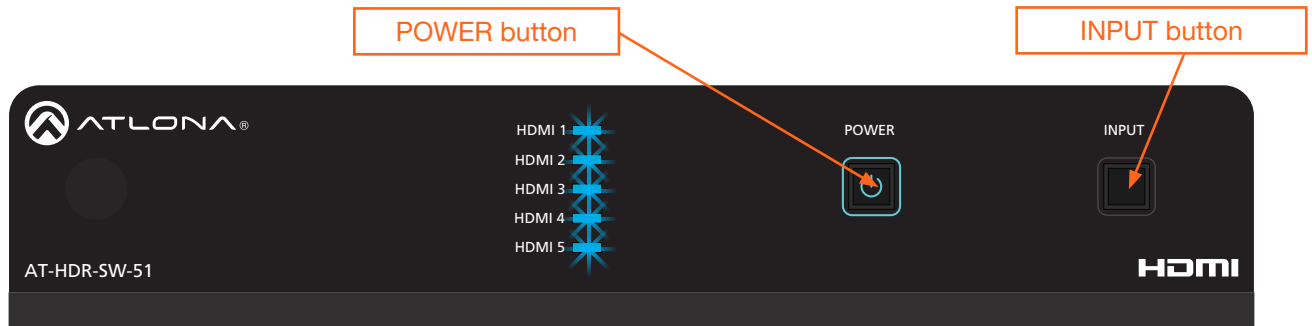

Configuration and Management Interfaces

Web Server

The AT-HDR-SW-51 includes a built-in web server. Atlona recommends that the web server be used to set up the AT-HDR-SW-51, as it provides intuitive management of all features. Refer to [Logging in after Registration \(page 17\)](#) for more information.

The AT-HDR-SW-51 is shipped with DHCP enabled. Once connected to a network, the DHCP server will automatically assign an IP address to the unit. Use an IP scanner to determine the IP address of the AT-HDR-SW-51. If a DHCP server cannot be located within 15 seconds, the AT-HDR-SW-51 will be placed in [Automatic Private IP Addressing \(APIPA\) Mode \(page 14\)](#). If a static IP address is desired, refer to [IP Configuration \(page 12\)](#).

Register page

This page is displayed when the AT-HDR-SW-51 web server is launched for the first time.

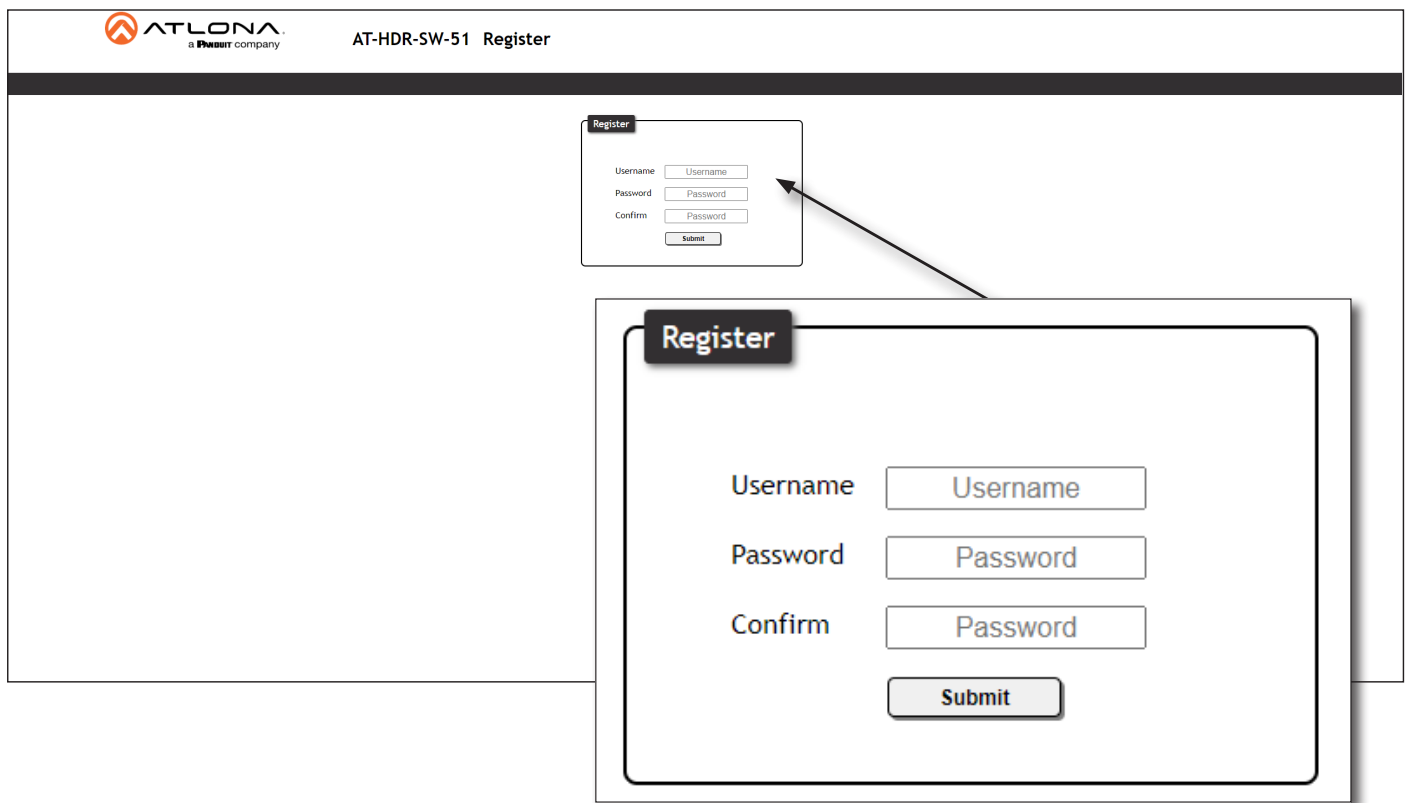

Username

Enter the desired username in this field.

Password

Enter the desired password in this field.

Confirm

Re-enter the desired password in this field.

Submit

Click this button to register the username and password with the AT-HDR-SW-51.

Configuration and Management Interfaces

Login page

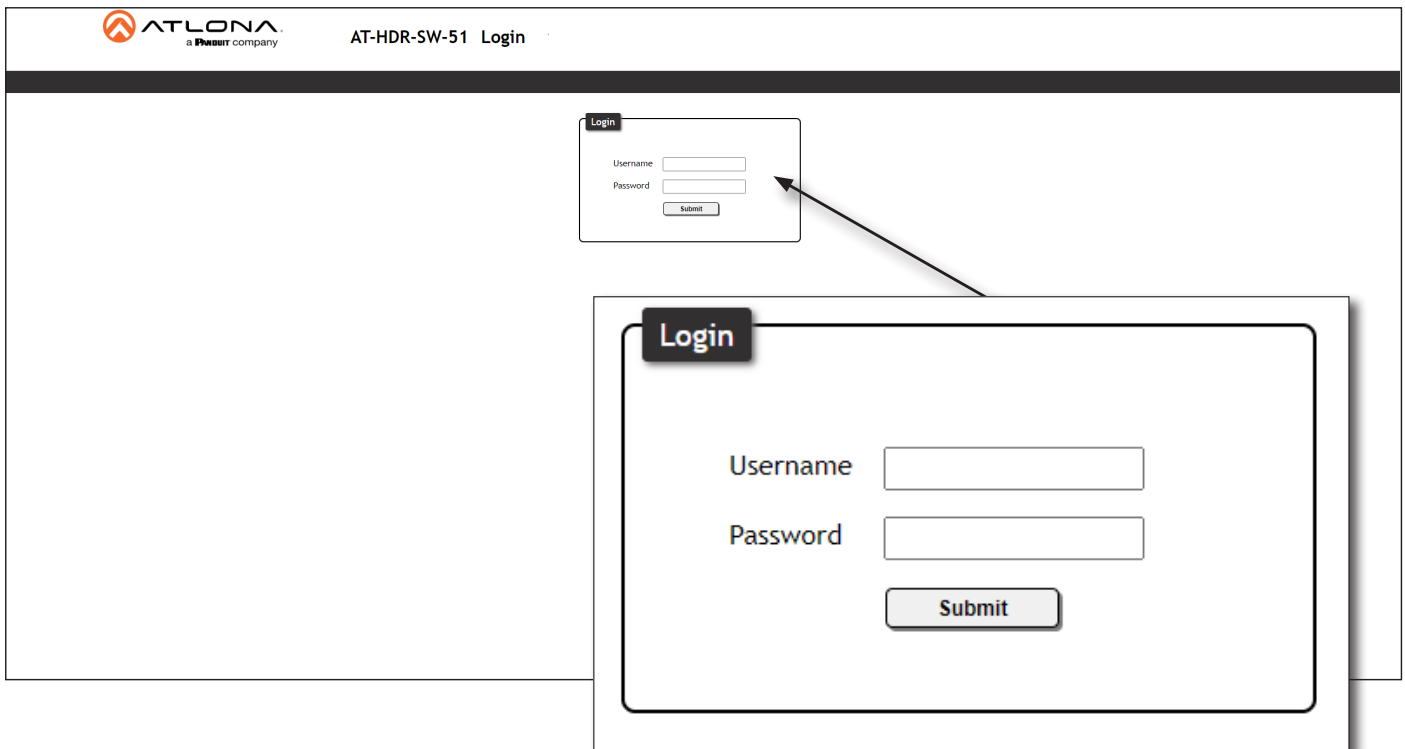

The screenshot shows the login page for AT-LONA AT-HDR-SW-51. The page header includes the AT-LONA logo and the text 'AT-HDR-SW-51 Login'. The main content area features a login form with the following elements:

- Username**: A text input field.
- Password**: A text input field.
- Submit**: A button.

A callout box provides a magnified view of the login form, showing the 'Username' and 'Password' labels, the input fields, and the 'Submit' button.

Username

Enter the username in this field.

Password

Enter the password in this field.

Submit

Click this button to log in.

Configuration and Management Interfaces

Info page

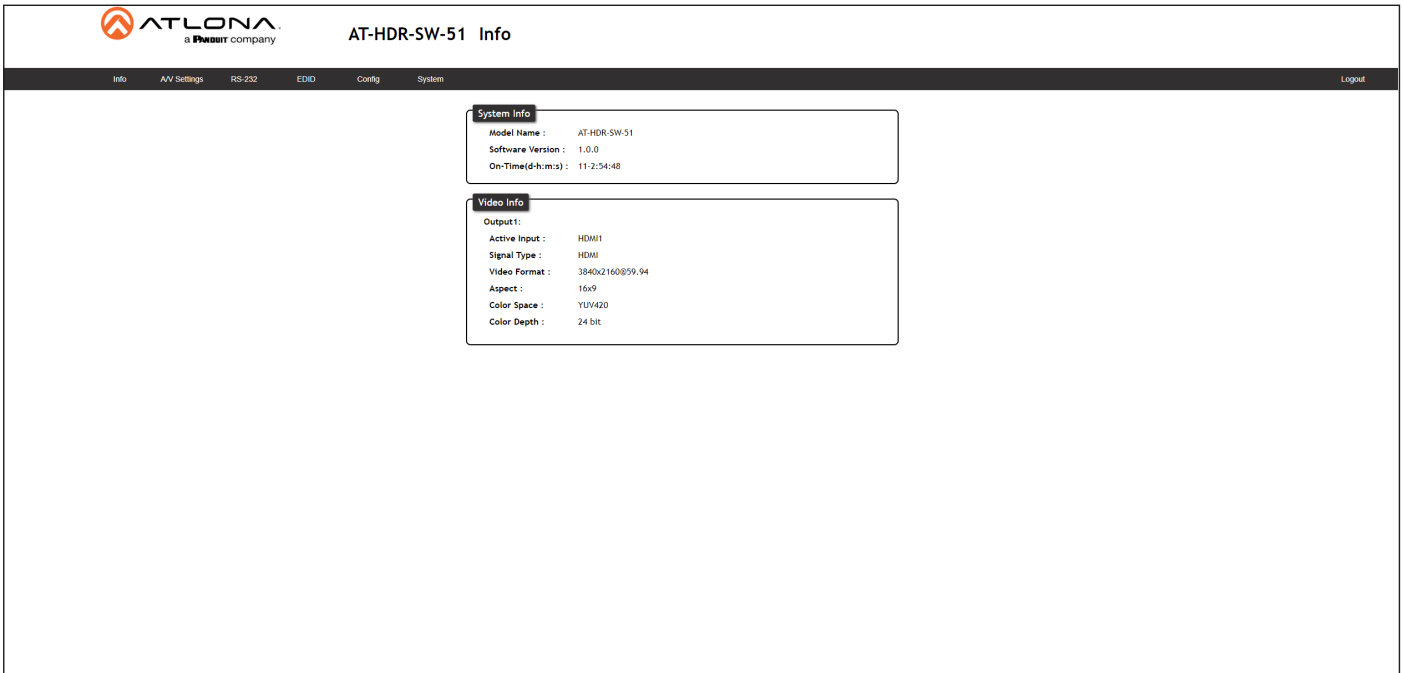

The screenshot shows the AT-HDR-SW-51 Info page. At the top, there is a navigation bar with tabs for Info, AV Settings, RS-232, EDID, Config, and System. The main content area is divided into two sections: System Info and Video Info.

System Info	
Model Name :	AT-HDR-SW-51
Software Version :	1.0.0
On-Time(d-h:m:s) :	11-2:54:48

Video Info	
Output1:	
Active Input :	HDMI1
Signal Type :	HDMI
Video Format :	3840x2160@59.94
Aspect :	16:9
Color Space :	YCbCr420
Color Depth :	24 bit

System Info

Model Name

The model SKU of this product.

Software Version

The version of firmware that the AT-HDR-SW-51 is running. Always make sure to check the AT-HDR-SW-51 product page, on the Atlona web site, for the latest version of firmware.

On-Time (d-h:m:s)

Displays the amount of time elapsed since the unit was powered.

Video Info

Displays signal information for the HDMI output.

Active Input

The input signal port name.

Signal Type

The type of input signal.

Video Format

The input resolution of the source device.

Aspect

Aspect ratio of the input signal.

Color Space

Displays the color space and chroma sub-sampling of the input signal.

Color Depth

The color depth of the input signal.

Configuration and Management Interfaces

A/V Settings page

The **A/V Settings** page is divided into three sections: **Video**, **Audio**, and **HDCP**. The **Video** section provides controls for switching modes and input selection. The **Audio** section provides options to control the output audio volume and de-embedding. The **HDCP** section controls whether or not HDCP content is allowed to pass.

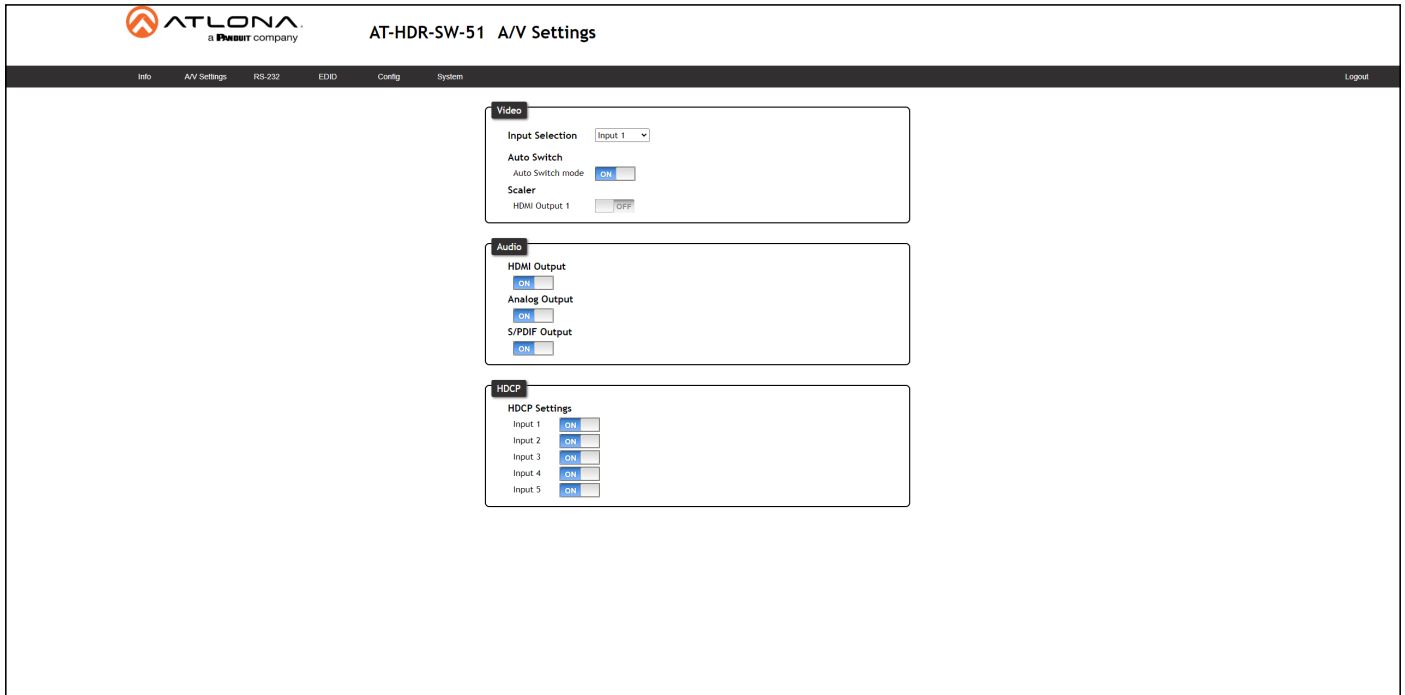

Video

Input Selection

Click this drop-down list to manually select the desired input.

Setting	Description
Input 1	Sets HDMI IN 1 as the active input.
Input 2	Sets HDMI IN 2 as the active input.
Input 3	Sets HDMI IN 3 as the active input.
Input 4	Sets HDMI IN 4 as the active input.
Input 5	Sets HDMI IN 5 as the active input.

Auto Switch

Click this toggle switch to enable or disable Auto Switching. When enabled, the AT-HDR-SW-51 will automatically switch to the another input, if the signal is disrupted on the currently active input.

Scaler

Click these toggle switches to enable or disable the scaler pass-through feature for the HDMI outputs. When set to the **ON** position, 4K content will be down-scaled to 1080p. When set to the **OFF** position, the output resolution / timing will be the same as the input source. The default setting is **OFF**.

Configuration and Management Interfaces

Audio

HDMI Output 1

Set this toggle to the **OFF** position to mute the audio on the **HDMI OUT 1** port.

Analog Output

Click this toggle switch enable or disable audio output on the **L/R** port.

S/PDIF Output

Click this toggle switch enable or disable audio output on the **S/PDIF OUT** port.

HDCP

Each input provides control of how HDCP content is handled. Some source devices will send HDCP content if an HDCP-compliant display (sink) is detected. However, there may be applications where sending HDCP content is not desired. Setting the port to the **OFF** position, will instruct the source to send non-HDCP content to the display. Note that not all sources have this capability. When set to **ON**, the source will have the ability to transmit HDCP content to the AT-HDR-SW-51.



NOTE: Setting this feature to **OFF**, for any source, does *not* provide decryption of HDCP content to non-HDCP compliant sink devices. Sources such as Mac[®] computers and the Sony PlayStation[®] will *always* transmit HDCP content.

Configuration and Management Interfaces

RS-232 page

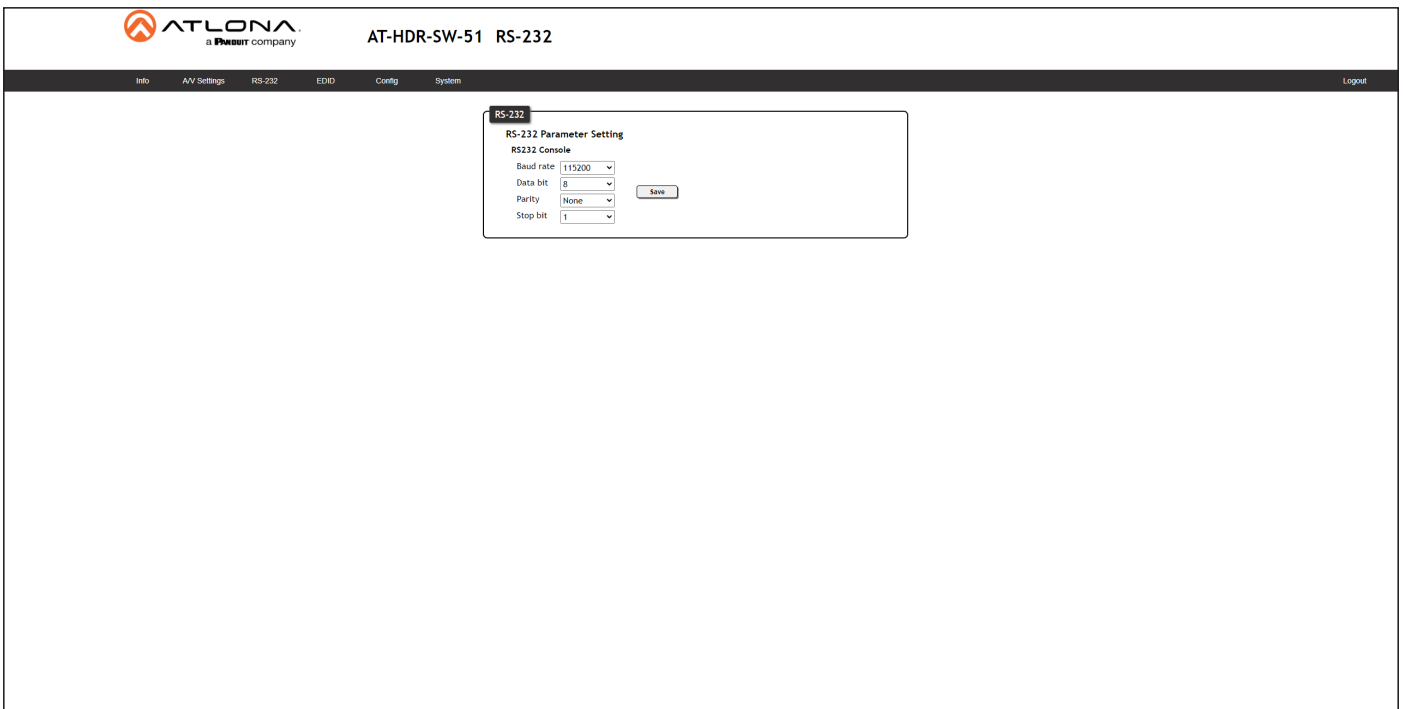

The screenshot shows the AT-HDR-SW-51 RS-232 configuration page. At the top, there is a navigation bar with 'Info', 'AV Settings', 'RS-232', 'EDID', 'Config', and 'System' tabs. The 'RS-232' tab is active. Below the navigation bar, there is a 'RS-232 Parameter Setting' dialog box. The dialog box has a title 'RS-232 Console' and four dropdown menus: 'Baud rate' (set to 115200), 'Data bit' (set to 8), 'Parity' (set to None), and 'Stop bit' (set to 1). A 'Save' button is located to the right of the dropdown menus.

RS-232

RS-232 Console

Sets the RS-232 port settings used for local control by a third-party control system.

Parameter	Description
Baud rate	Sets the baud rate. The following options are available: 2400, 4800, 9600, 19200, 38400, 57600, 115200.
Data bit	Sets the number of data bits used to represent each character of data. The following options are available: 7 or 8.
Parity	Sets the parity bit, which can be included with each character to detect errors during the transmission of data. The following options are available: None, Odd, or Even.
Stop bit	Sets the stop bit. Stop bits are sent at the end of each character, allowing the client to detect the end of a character stream. The following options are available: 1 or 2.

Configuration and Management Interfaces

EDID page

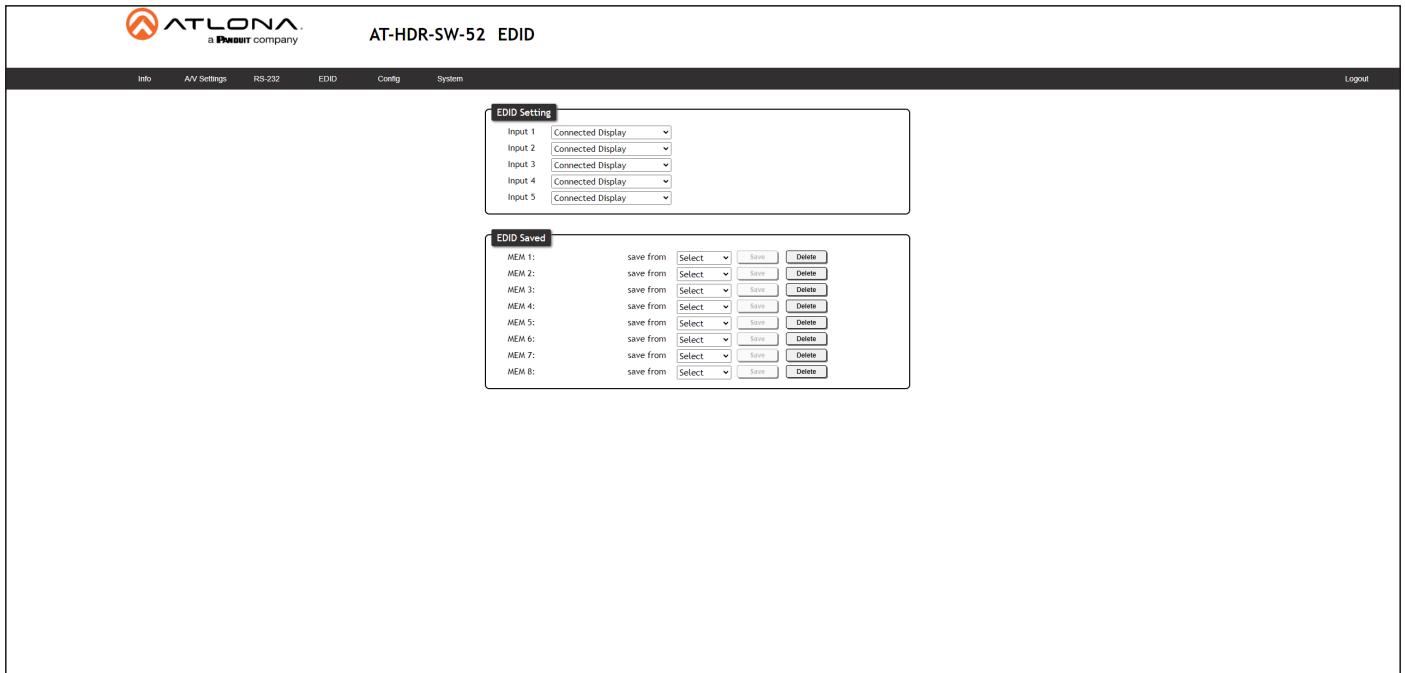

EDID Settings

Click these drop-down lists to select the desired EDID to be used for each input. The following EDID presets are available. When selecting an EDID, make sure that the display/sink device is capable of supporting the resolution/timing. If the sink device is not able to support a feature, then the source will not be displayed. Selecting the **Connected Display** EDID will provide the most compatible settings for most displays. In addition, eight memory locations are available for storing captured EDID data. If an EDID is stored in a memory location, it will also be added to the list available EDID selections.

EDID	Description
Connected Display	Uses the downstream EDID of the connected display
ATL 4K60 MCH	3840 x 2160 (UHD) with multichannel audio support
ATL 4K60 PCM MCH	3840 x 2160 (UHD) with PCM multichannel audio support
ATL 1080P MCH	1920 x 1080p with multichannel audio support
ATL 1080P 2CH	1920 x 1080p with two-channel audio support
ATL 1080P DD	1920 x 1080p with Dolby™ Digital audio support
ATL 1080P DVI	1920 x 1080p for DVI displays
ATL 720P DD	1280 x 720p with Dolby™ Digital audio support
ATL 720P 2CH	1280 x 720p with two-channel audio support

EDID Saved

The AT-HDR-SW-51 provides eight memory locations used for storing captured EDID data. Click these drop-down lists to select the desired output and press Save to store the EDID. Press the Delete button to erase the EDID data. Refer to [EDID Management \(page 27\)](#) for more information.

Configuration and Management Interfaces

Config page

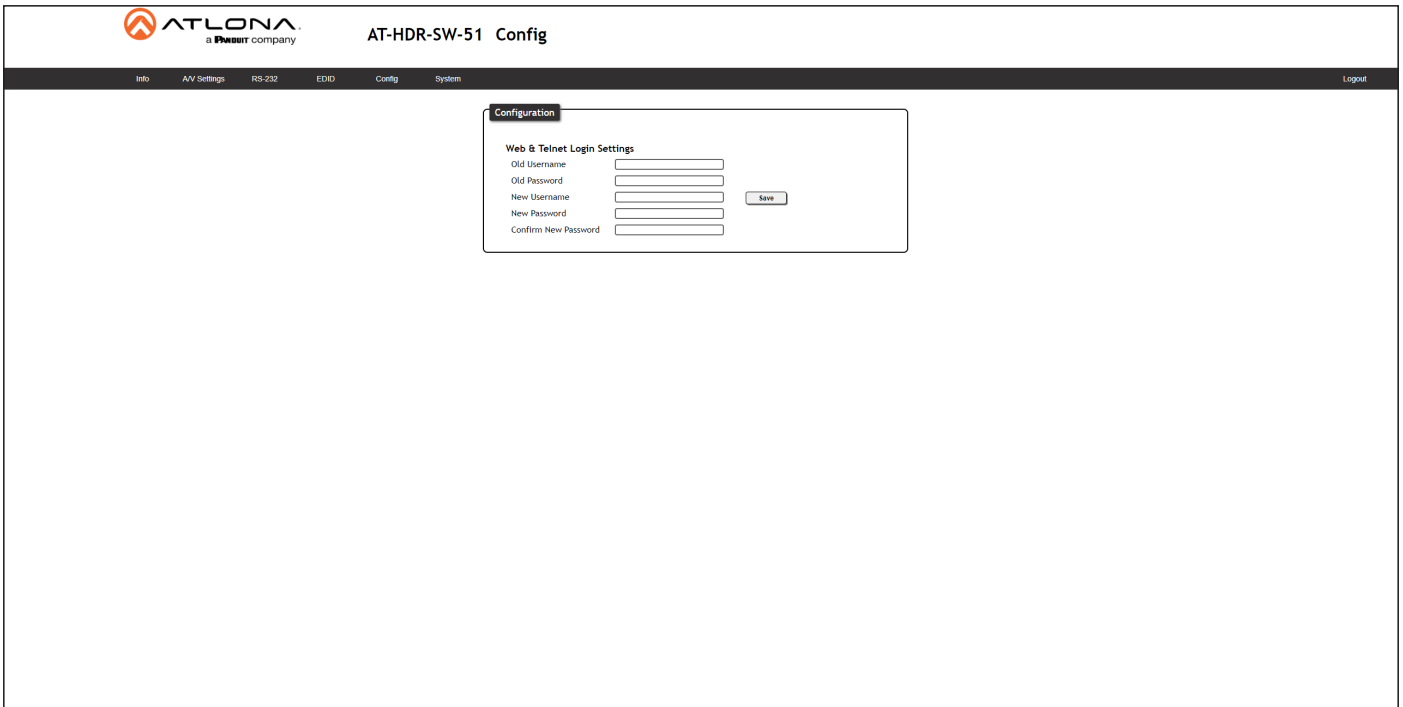

The screenshot displays the configuration interface for the AT-HDR-SW-51 device. At the top, the AT-LONA logo and 'a PANOUT company' are visible. The page title is 'AT-HDR-SW-51 Config'. A navigation bar includes links for 'Info', 'AV Settings', 'RS-232', 'EDID', 'Config', and 'System', with 'Config' being the active tab. A 'Logout' link is also present. The main content area features a 'Configuration' tab and a 'Web & Telnet Login Settings' form. The form contains five input fields: 'Old Username', 'Old Password', 'New Username', 'New Password', and 'Confirm New Password'. A 'Save' button is located to the right of the 'New Password' field.

Configuration

Old Username

Enter the current username in this field.

Old Password

Enter the current password in this field.

New Username

Enter the new username in this field.

New Password

Enter the new password in this field.

Confirm New Password

Verify the new password by retying it in this field.

Save

Click this button to apply all changes.

Configuration and Management Interfaces

System page

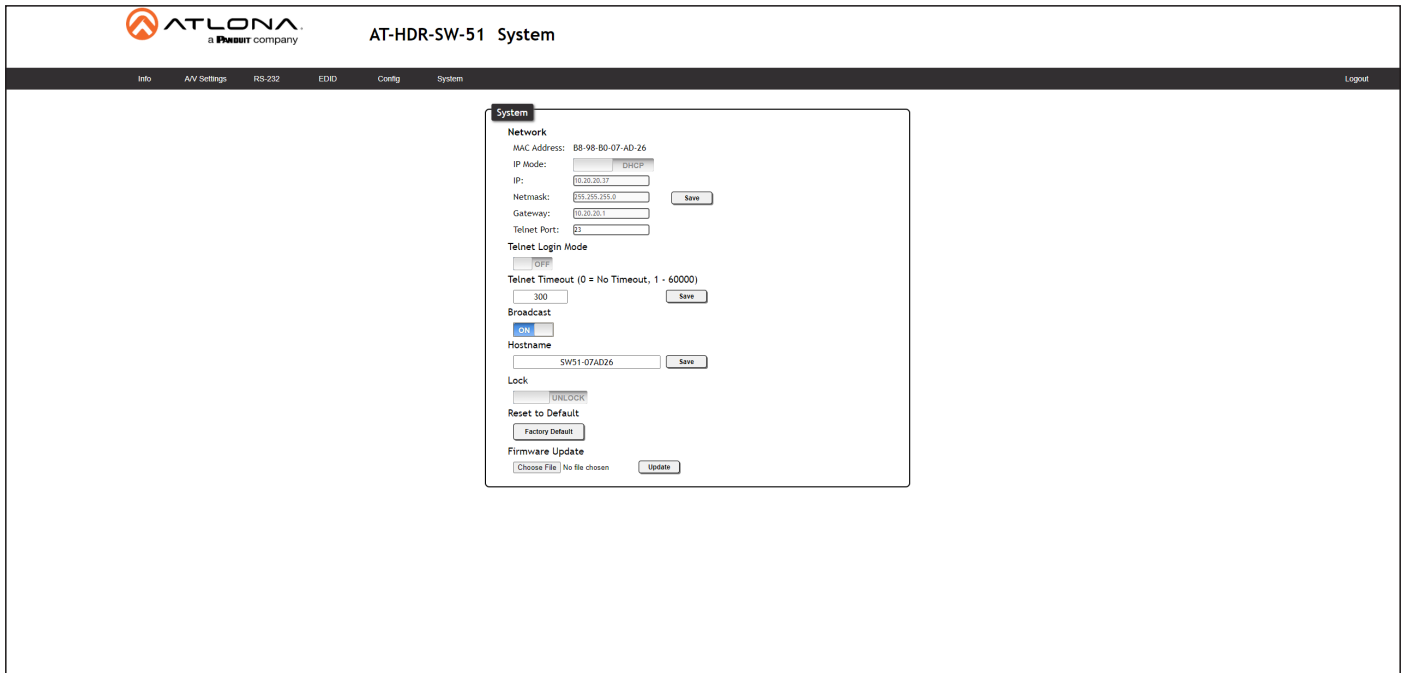

System

MAC address

Displays the MAC address of the AT-HDR-SW-51.

IP Mode

Click this toggle to set the IP mode of the AT-HDR-SW-51.

Setting	Description
DHCP	Uses an available DHCP server to assign an IP address.
STATIC IP	Allows the IP address, subnet mask, and gateway IP address to be entered manually.

IP

Enter the IP address of the AT-HDR-SW-51 in this field. This field will only be available if **IP Mode** is set to `STATIC IP`.

Netmask

Enter the subnet mask in this field. This field will only be available if **IP Mode** is set to `STATIC IP`.

Gateway

Enter the gateway (router) address in this field. This field will only be available if **IP Mode** is set to `STATIC IP`.

Telnet Port

Enter the Telnet listening port in this field.

Telnet Login Mode

Click this toggle to set the login mode to either `ON` or `OFF`. If this feature is set to `ON`, then use the same login credentials as the web server.

Setting	Description
ON	The AT-HDR-SW-51 will prompt for both the username and password at the start of a Telnet session.
OFF	No username and password is required for Telnet sessions.

Configuration and Management Interfaces

Telnet Timeout

Sets the Telnet timeout interval, after no activity, in seconds. Acceptable integer values are: 0 - 60000. The default setting is 300. Once the interval has expired, the Telnet session will be closed. If this field is set to 0, then the timeout interval is infinite. Click the **Save** button to commit changes.

Broadcast

This option determines whether or not systems changes are announced over TCP/IP connections to any listening devices.

Setting	Description
ON	System changes will be announced over TCP/IP connections to any device that has a TCP/IP connection to the AT-HDR-SW-51. This is the default setting.
OFF	Only the device that is sending the commands will receive feedback from the commands or any system changes. Read queries, such as the <code>IPCFG</code> and <code>Type</code> commands, are not announced and will only return information to the requester.

Hostname

Displays the hostname of the AT-HDR-SW-51, as it would appear on a network. To change the hostname, type the new hostname in this field and click the **Save** button. Refer to [Setting the Host Name \(page 36\)](#) for more information.

Lock

Click to lock or unlock the buttons on the front panel. Locking the front panel buttons is useful in preventing accidental button activation within rack environments.

Setting	Description
LOCK	Locks the front panel buttons.
UNLOCK	Unlocks the front panel button, allowing them to be functional.

Reset to Default

Click the **Factory Default** button to set the AT-HDR-SW-51 to factory-default settings.

Firmware Update

Click the **Choose File** button to select the firmware file, when upgrading the firmware on the AT-HDR-SW-51. Once the firmware file is selected, click the **Update** button. Refer to [Updating the Firmware \(page 50\)](#) for more information.

Appendix

Updating the Firmware

Updating the firmware can be completed using either the USB interface or the web server. Atlona recommends using the web server for updating the MCU firmware. However, if a network connection is not available, the AT-HDR-SW-51 firmware can be updated using a USB-A to mini-USB cable. USB update is not supported under macOS®.

Using the Web Server

Requirements:

- AT-HDR-SW-51
 - Firmware file
 - Computer
1. Connect an Ethernet cable from the computer, containing the firmware, to the same network where the AT-HDR-SW-51 is connected.
 2. Log in to the web server and go to the [System](#) page (page 48).

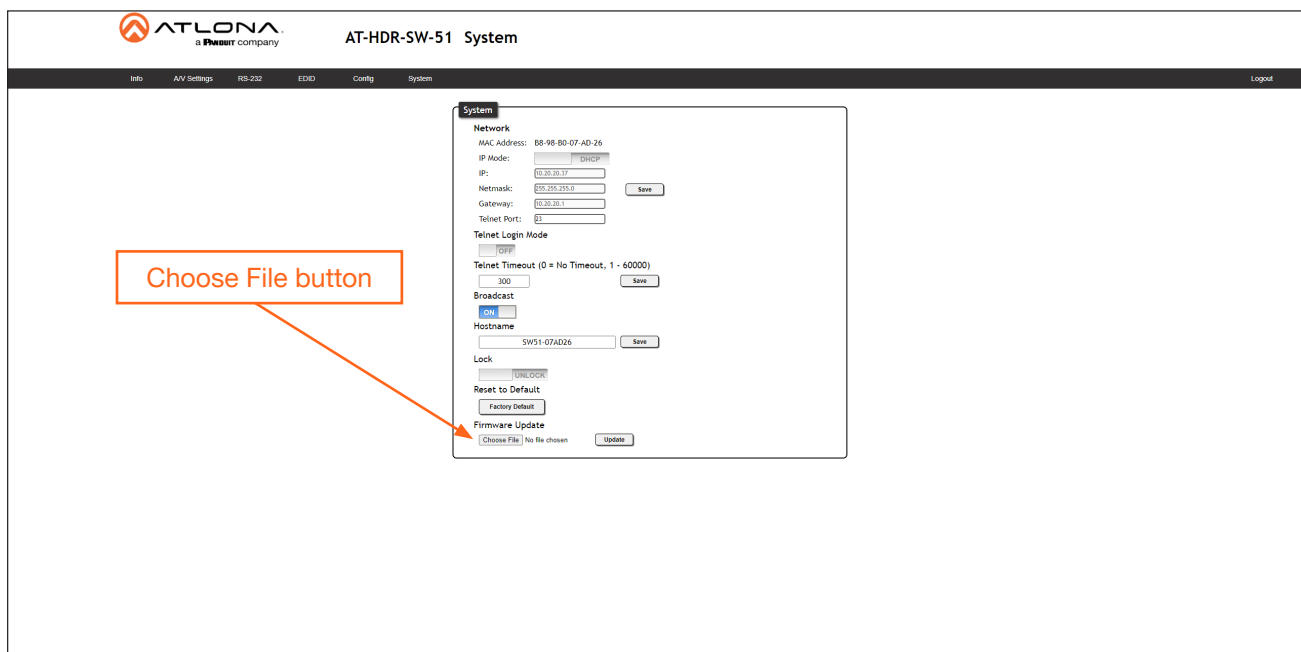

3. Click the **Choose File** button, under **Firmware Update**.
4. Browse to the location of the firmware file, select it, and click the **Open** button.
5. Click the **Update** button to begin the update process. The following message box will be displayed.

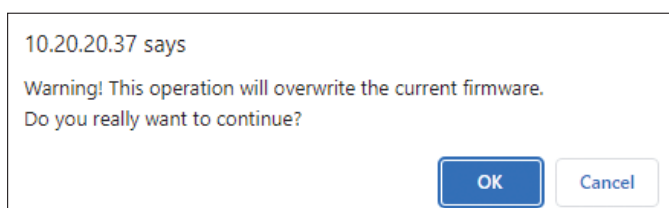

6. Click the **OK** button to begin the firmware update process. Click the **Cancel** button to cancel the process.
7. After the firmware update process is complete, the **Login** screen will be displayed, indicating that the update process is complete.

Using USB

Required items:

- AT-HDR-SW-51
- Computer containing the firmware file.
- USB-A to mini-USB cable



NOTE: USB update is not supported on macOS®.

1. Disconnect power from the AT-HDR-SW-51.
2. Connect the USB-A to mini-USB cable between the computer and the **FW** port on the AT-HDR-SW-51.



3. Press and hold down the **INPUT** button on the front panel, while connecting the power supply to the AT-HDR-SW-51. Once the power supply has been connected, release the **INPUT** button.
4. The **POWER** button will begin flashing slowly, indicating that the AT-HDR-SW-51 is in *Update Mode*.

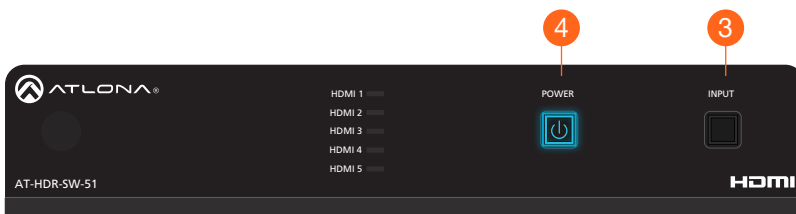

5. A virtual USB drive will be displayed in a pop-up window on the computer. Drag-and-drop the firmware file to the virtual drive. During the firmware update procedure, the **POWER** button will flash more rapidly.

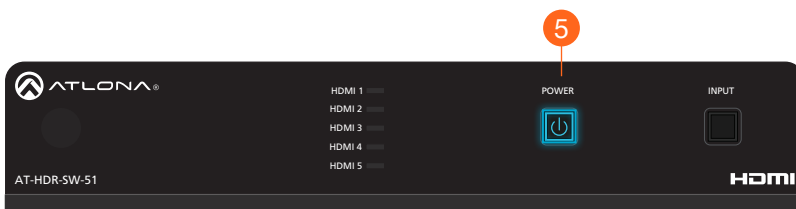

6. After the file has been copied, disconnect the USB cable from both the computer and the AT-HDR-SW-51.
7. The firmware update process is complete.

Mounting Instructions

The AT-HDR-SW-51 includes two mounting brackets, which can be used to attach the unit to any flat surface. Use the two enclosure screws, on the sides of the unit to attach the mounting brackets.

Single Unit Rack Installation

1. Attach the included small rack ear to one side of the AT-HDR-SW-51, using the included screws.
2. Attach the included longer rack ear to the opposite side of the AT-HDR-SW-51 using the included screws.



Dual Unit Rack Installation

1. Turn both units upside-down on a flat surface, next to each other, as shown.
2. Position the included mounting plate over the pre-drilled holes on the bottom of the enclosure. When attaching the mounting plate, the countersink bevels on the mounting plate should face upward.

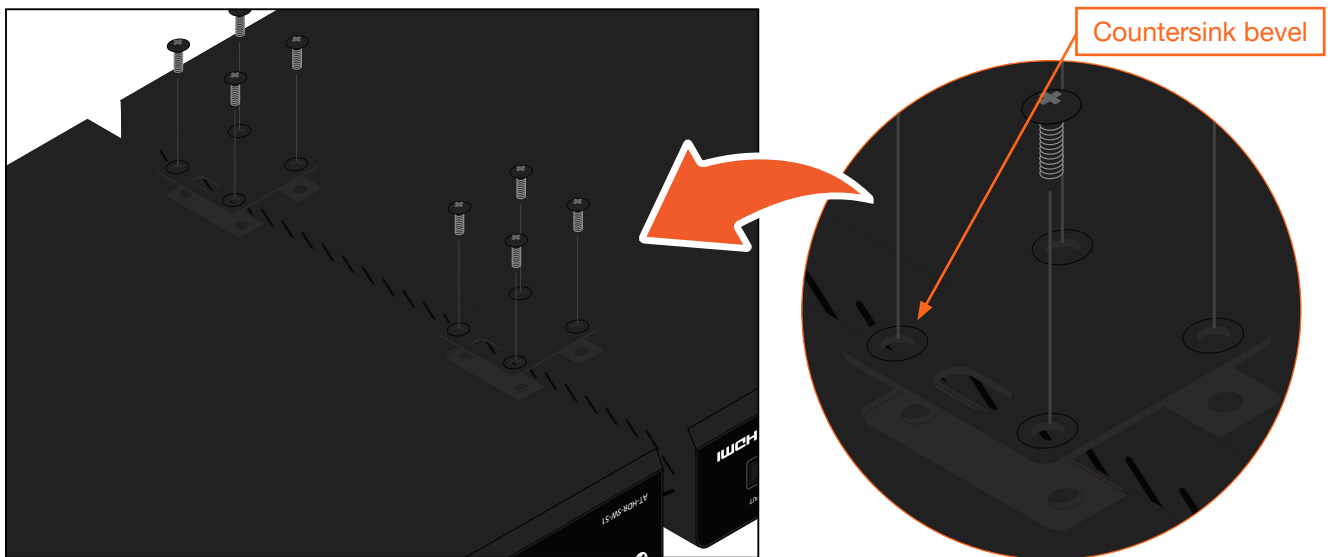

3. Turn the attached units over and install the rack ears (sold separately) to one side of each enclosure using the included screws.



Flat Surface

1. Turn the unit upside down, on a flat surface.
2. Position the included mounting plates over the pre-drilled holes on the bottom of the enclosure. When attaching mounting plates, the countersink bevels on the mounting plates should face upward.



3. Mount the unit using the circular holes, on each mounting plate. If using a drywall surface, a #6 drywall screw is recommended. Mounting screws are not included.



NOTE: The unit can also be mounted under a flat surface, such as a table, by turning the unit upside down.

Specifications

Video		
Signal	Input - HDMI Output - HDMI	
Copy Protection	HDCP 2.2	
Pixel Clock	600 MHz	
UHD/HD/SD	4096x2160 (DCI) @ 24/25/30/50/60 Hz 720x576p @ 50 Hz 3840x2160 (UHD) @ 24/25/30/50/60 Hz 720x576i @ 25/50 Hz 1920x1080p @ 720x480p @ 60 Hz 23.97/24/25/29.97/30/50/60 Hz 640x480p @ 60 Hz 1920x1080i @ 50/60 Hz 640x480i @ 60 Hz 1280x720p @ 30/50/60 Hz	
VESA	2560x2048	1366x768
All resolutions are 60 Hz	2560x1600	1360x768
	2048x1536	1280x1024
	1920x1200	1280x800
	1680x1050	1280x768
	1600x1200	1152x768
	1600x900	1024x768
	1440x900	800x600
	1400x1050	640x480
Color Space	YUV, RGB	
Chroma Subsampling	4:4:4, 4:2:2, 4:2:0	
Color Depth	8-bit, 10-bit, 12-bit	
HDR	HDR10, Hybrid-Log Gamma (HLG), and Dolby® Vision™ @ 60 Hz	

Audio			
HDMI Pass-Through Formats	LPCM 2.0 LPCM 5.1 LPCM 7.1	Dolby® Digital Dolby Digital Plus™ Dolby TrueHD Dolby Atmos®	DTS® Digital Surround™ DTS-HD Master Audio™ DTS:X®
S/PDIF	LPCM 2.0	Dolby® Digital	DTS® Digital Surround™
Bit Depth	Up to 24 bits		
Analog Audio			
Format	Stereo 2-Channel		
Output	+4 dBu nominal gain, +19 dB headroom		
Frequency Response	20 Hz to 20 kHz, ± 0.5 dB		
THD+N	< 0.006% at 20 Hz to 20 kHz		
SNR	> 105 dB at 1 kHz, zero clipping @ 0 dBFS, unweighted		
Sample Rate	32 kHz, 44.1 kHz, 48 kHz, 88.2 kHz, 96 kHz, 176.4 kHz, 192 kHz		

Ethernet	
Port	1 x RJ45
Standards and Protocols	HTTP, Telnet
Speeds	10/100 Mbps
Addressing	DHCP, Static – selectable through built-in web server and Telnet commands

RS-232	
Port	1 x 3-pin captive screw
Use	Unit and external device control and configuration
Baud Rates	2400, 4800, 9600, 19200, 38400, 57600, 115200
Data Flow	Bidirectional

Resolution / Distance	4K/UHD - Feet / Meters		1080p - Feet / Meters	
HDMI IN/OUT	15	5	30	10

Buttons and Indicators	
Buttons: POWER, UP, DOWN, INPUT	4 x momentary, tact-type
Indicators: POWER HDMI 1 - HDMI 5	1 x LED, blue 5 x LED, blue

Connectors	
HDMI IN	5 x Type A, 19-pin female
HDMI OUT	1 x Type A, 19-pin female
LAN	1 x RJ45
L/R	2 x RCA, female
S/PDIF OUT	1 x RCA, female
RS-232	1 x 3-pin captive screw
FW	1 x mini-USB
DC 5V	1 x 2-pin captive screw

Environmental	Fahrenheit	Celsius
Operating Temperature	+32 to +122	0 to +50
Storage Temperature	-4 to +140	-20 to +60
Operating Humidity (RH)	20% to 90%, non-condensing	

Power	
Consumption	13.53 W
BTU/h	46.1
External Power Supply	100 - 240 V AC, 50/60 Hz Output: 5 V / 4 A DC

Dimensions (H x W x D)	Inches	Millimeters
Unit	1.34 x 8.19 x 4.41	34 x 208 x 112
Power Supply (AT-PS-54-C)	1.20 x 2.00 x 3.20	30 x 51 x 81

Weight	Pounds	Kilograms
Device	1.44	3.15

Certification	
Device	CE, RoHS, FCC
Power Supply	CE, FCC, UL, CUL, TUV-GS, CB, PSE, CCC

Compliance	
NDAA-889	Yes
TAA	Yes

Warranty	
Device	To view the product warranty, use the following link: https://atlon.com/warranty

